

DESOTO
1959



SPACIOUS FASHION-VOGUE INTERIOR is tailored in a beautiful new white and gold combination of textured Nylon Casino Corde fabric and a soft, handsome vinyl.

The Adventurer 2-door hardtop

The De Soto Adventurer

PURE GOLD . . . IN RIDE, PRIDE AND PLEASURE



The Adventurer convertible

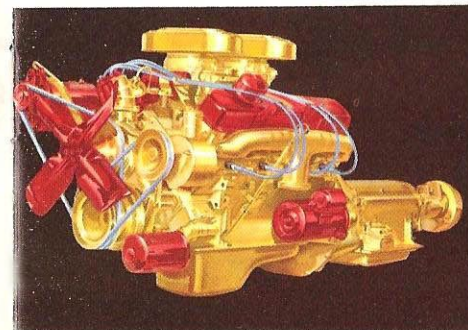

FABULOUS ADVENTURER ENGINE

. . . with two 4-barrel carburetors and hi-lift cams that open valves wider and longer. The Adventurer engine responds smoothly with split-second precision to the improved push-button control transmission.

What a thrill De Soto's great luxury car is . . . styled to be stunningly beautiful . . . engineered to handle like a thoroughbred . . . built to ride as softly as passing summer clouds.

The Adventurer's graceful, aristocratic body is cradled by new and improved Torsion-Aire suspension. And now available is an exclusive De Soto air suspension system—the Level-Cruise ride. It gives you all the load-leveling benefits of air suspension *plus* all the stability of Torsion-Aire ride.

Effortless, confident driving is yours with the Adventurer's Constant Control power steering, Safe-Stop power brakes and push-button control transmission. New Sports Swivel Seats make getting in and out easier than ever.

For a thrilling, all-new adventure in driving . . . drive the all-new 1959 Adventurer.



FIREFLITE 4-DOOR SPORTSMAN



PARISIAN TWEED . . . A SMART, NEW FABRIC with an elegant look and a practical feel . . . combines with rich, rugged vinyl to make this Fireflite interior a standout for stylish flair and long wear.

De Soto Fireflite

**TOUCH THE BUTTON . . .
AND FEEL LUXURY COME TO LIFE**

Everything you see, everything you touch, is new. Turboflash V8 engines respond instantly to push-button transmission. You ride on the velvety new, improved Torsion-Aire suspension system.

Now available with fabulous Adventurer engine!



FIREFLITE 2-DOOR SPORTSMAN



FIREFLITE 4-DOOR SEDAN



FIREFLITE CONVERTIBLE



NASSAU PLAID, IN "CARIBBEAN SUN" COLORS, is a happy combination of sparkling colors and carefree fabric. Created specially to give added smartness to the beautiful 1959 De Soto Sportsman.

De Soto Firedome

**BRIGHT YOUNG SIGN
OF SUCCESS**

The handsome new De Soto Firedome offers value that far exceeds its price! Powering it are new and improved De Soto Turboflash V8 engines. Supporting it softly is the famous Torsion-Aire suspension system. Now available with fabulous Adventurer engine!



FIREDOME 2-DOOR SPORTSMAN



FIREDOME 4-DOOR SEDAN



FIREDOME 4-DOOR SPORTSMAN



FIREDOME CONVERTIBLE



SCULPTURED NYLON gives Firesweep interiors a richness and luxury unmatched by cars costing much more. Every stitch, every bit of fabric is carefully tailored to give you smart new beauty and durability.

De Soto Firesweep

**PROVES HOW EASY
IT IS TO OWN A DE SOTO**

The Firesweep offers features that would cost hundreds extra on many competitive cars . . . features such as Turboflash V8 engines, Torsion-Aire suspension system, Safe-Stop brakes. Its Flair Stream styling is distinctive. And yet the 1959 Firesweep is priced scarcely above the lowest! Now available with fabulous Adventurer engine!

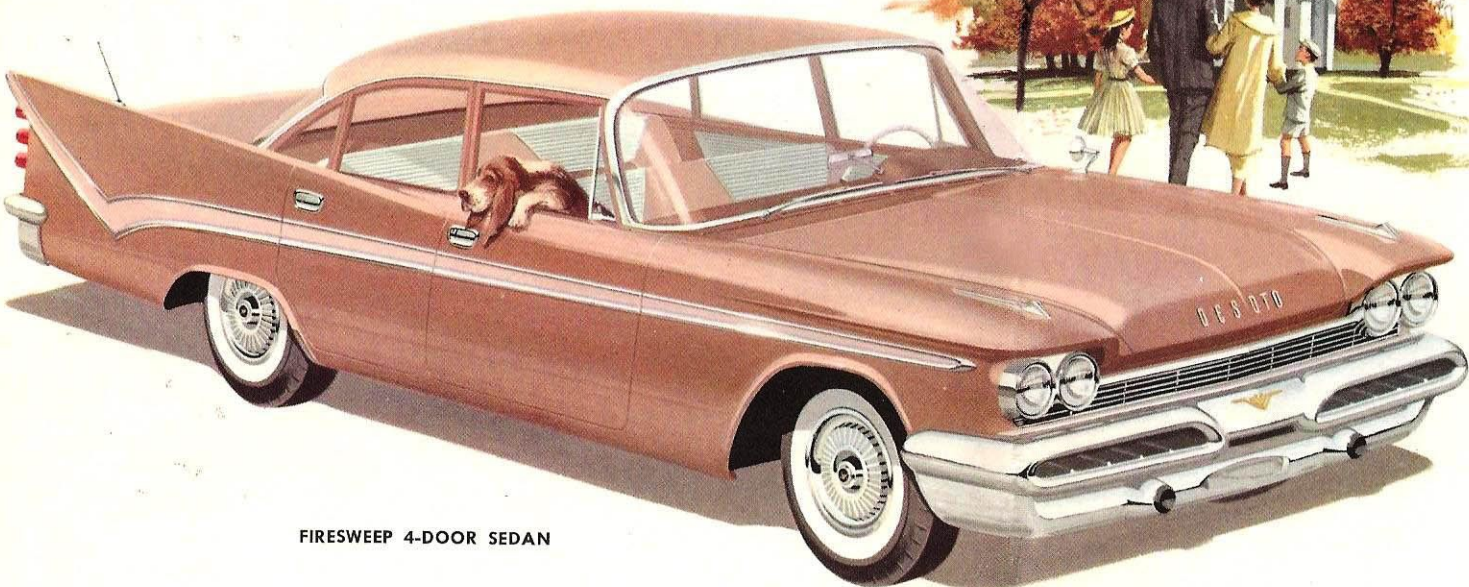

FIRESWEEP 4-DOOR SEDAN



FIRESWEEP CONVERTIBLE



FIRESWEEP 4-DOOR SPORTSMAN



FIRESWEEP 2-DOOR SPORTSMAN



Children love the De Soto Explorer's rear-facing Vista-seat. This third seat, and the second seat, can be lowered flat to give 95 cubic feet of cargo area in the 9-passenger Explorer. The power-operated, full-width Vista-Vu window rolls into the one-piece tail gate. Handy tail gate steps make it easy to get in and out of the third seat.



De Soto's 6-passenger Shopper station wagon is perfect for the family that doesn't need the Explorer's "room for nine". It has the same cargo capacity as the Explorer, and that's loads of room for "do-it-yourself" hauling projects, camping, hunting or fishing. You can actually put a healthy sized boat in a De Soto wagon.



FIREFLITE 4-DOOR SHOPPER



FIRESWEEP 4-DOOR SHOPPER

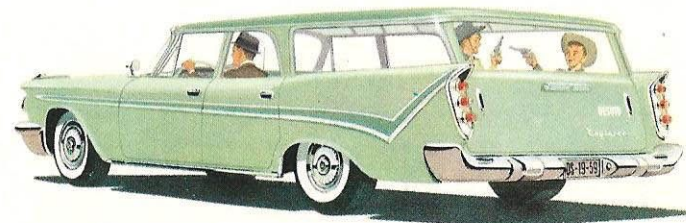

FIRESWEEP 4-DOOR EXPLORER

De Soto Station Wagons

SURE THEY'RE BIG . . . AND ARE THEY FUN!

De Soto station wagons give you extra power . . . extra comfort . . . extra wheelbase, that lesser wagons simply can't match! They're the *roomiest* wagons of all. Solid, safe and road-hugging for family vacations . . . rugged for hunting and fishing trips . . . easy-driving for Mother's shopping trips. Plan a "Futureful of fun" . . . in a new De Soto station wagon!

Now available with fabulous Adventurer engine!



FIREFLITE 4-DOOR EXPLORER STATION WAGON



With all three seats up, you have room for nine in the De Soto Explorer.



With Vista-seat down, you have seats for six and lots of cargo room.



Both seats down gives you room for three and 95 cu. ft. of cargo space.

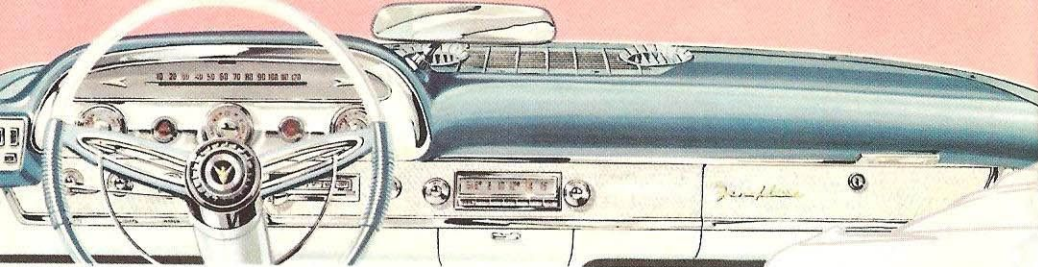

De Soto's new full-view instrument panel and steering wheel make driving easier, safer. An instrument panel safety cushion is standard on Firedomes and Fireflites. The new Safety Color Accuribbon speedometer is green up to 30 mph, switches to white between 30 and 50 mph, and flashes to red when you go over 50 mph.



NEW SPORTS SWIVEL SEATS. Touch a lever in the new De Soto and your half of the front seat swings gently out. Enter, and it swings you in and locks in place. Standard equipment on the De Soto Adventurer.

NEW LEVEL-CRUISE RIDE FEATURES AIR CUSHIONS

For '59, De Soto adds automatic load-leveling rear air cushions to an improved torsion-bar suspension. This engineering advance, combined with De Soto's longer wheelbase and stabilizing weight, gives you Level-Cruise, America's safest, smoothest ride. It eliminates nose-dive stops, and rear-squat starts. Prevents rear end sag when the car is loaded, and keeps your headlights level for added safety.

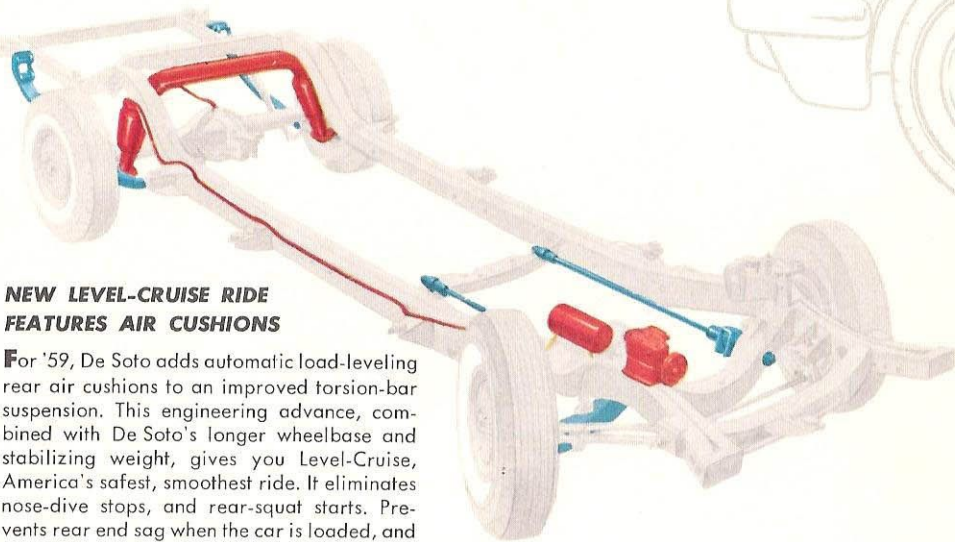

...and still more ways De Soto makes driving a pleasure...

The all-new 1959 De Soto offers many more pleasant surprises than the ones you see in these pages. The newness goes deeper than the beauty you see . . . the comfort you enjoy . . . and the engine response you feel. Much of this newness is in the painstaking engineering

improvements and in standards of material quality that are constantly being raised. Drive the 1959 De Soto and you'll be convinced—De Soto has more to offer you in style, action and value than any other car on the road! Try it! It's a brand-new driving experience.

NEW FASHION-VOGUE INTERIORS give you more head, leg, and shoulder room. Foam rubber padding in rear seats is standard in Adventurers, Fireflites, and Firedomes, and in front seats of all models.





New Sports Swivel Seat

The first really new idea in seat design

Open the door, swivel the seat outward, and you step out easily and gracefully. When you re-enter and swivel around to the normal straight-ahead position, the seat locks into place *securely and automatically*. A pull-down arm rest between the seats gives you additional comfort. Standard on the Adventurer, available on many Fireflite and Firedome models.



FOUR-SEASON PUSH-BUTTON AIR CONDITIONER

Powerful Airtemp system cools and heats, too! It gives you springtime weather any time of year.



STATION WAGON AIR CONDITIONER

All the cooling advantages of Four-Season air conditioning, plus the extra capacity necessary to cool the larger interiors of De Soto wagons.



ADVENTURER ENGINE

You can enjoy the fabulous Adventurer engine in any 1959 De Soto. This triumph of engineering has two 4-barrel carburetors and hi-lift cams.



MIRROR-MATIC MIRROR

Headlights behind you "set" mirror to cut glare. When car passes, mirror returns to normal.

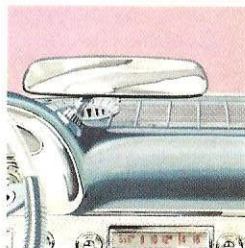

3-WAY PRISMATIC MIRROR

Position #1 is for daytime driving, #2 for normal night driving, #3 protects your eyes from extreme night glare.

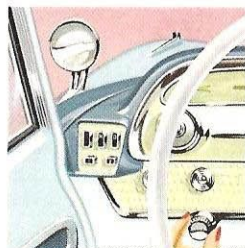

REMOTE CONTROL OUTSIDE REARVIEW MIRROR

You can compensate for eye level changes by turning a dash-located control knob.



OUTSIDE REARVIEW MIRROR

Blind spots are all but eliminated by using this attractive, easy-to-adjust rear view mirror.

1959 DE SOTO optional equipment and accessories

- 1.
- 2.
- 3.
- 4.

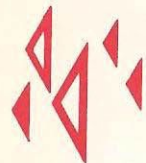

Your new De Soto will be even more beautiful, even more fun to drive with the genuine De Soto accessories shown inside. They all add to the pleasure of owning a De Soto—and at a surprisingly low cost. Some of these accessories are standard on the Adventurer, Fireflite, and Firedome series. Your dealer will be happy to help you select the ones that best fit your needs.

1959 De Soto Accessory Groups

To make it easier for you to order the optional equipment you want, De Soto has put together a number of accessory GROUPS. Each group contains selected accessories that normally go together and that most De Soto buyers like to order as a unit.

FIREFLITE SERIES

Accessory Group Number One

Auto-Temp push-button heater
Touch-Tuner radio
Rear seat speaker (except convertible and station wagon)
Dual exhausts
Stone deflectors
Outside left mirror
3-way Prismatic mirror
Vanity mirror
License plate frame

Accessory Group Number Two

(Includes all accessories listed above in Group Number One, PLUS:)
Station Seeker radio (replaces Group One radio)
Power windows
6-way power seat
Outside left remote control mirror (replaces Group One mirror)
Triad horn

Accessory Group Number Three

(There is no Accessory Group Number Three for Fireflite.)

FIREDOMES SERIES

Accessory Group Number One

Auto-Temp push-button heater
Dual-jet windshield washers
Hand brake signal light
Outside left mirror
3-way Prismatic mirror
Vanity mirror
License plate frame
Ash tray light
Trunk light

Accessory Group Number Two

(Includes all accessories listed above in Group Number One, PLUS:)
Touch-Tuner radio
Rear seat speaker (except convertible)
Electric clock

Accessory Group Number Three

(Includes all accessories listed above in both Groups One and Two, PLUS:)
Constant Control power steering
Safe-Stop power brakes
Dual exhausts

FIRESWEEP SERIES

Accessory Group Number One

Auto-Temp push-button heater
Dual-jet windshield washers
Variable speed windshield wipers
Outside left mirror
3-way Prismatic mirror
Vanity mirror
License plate frame
Map and glove box light
Ash tray light
Trunk light (rear dome light in station wagons)

Accessory Group Number Two

(Includes all accessories listed above in Group Number One, PLUS:)
Touch-Tuner radio
Wheel Covers
Back-up lights
Hand brake signal light

Accessory Group Number Three

(Includes all accessories listed above in both Groups One and Two, PLUS:)
Constant Control power steering
Safe-Stop power brakes
Electric clock

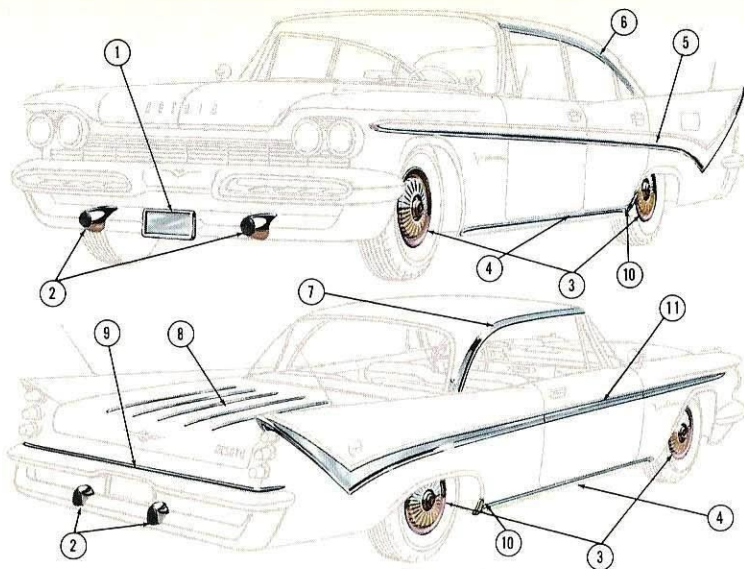

Optional Exterior Trim

- | | | |
|---------------------------------|--------------------------------------|------------------------------------|
| 1. License plate frame. | 5. Color sweep moulding. | 8. Deck lid accent stripes. |
| 2. Rubber-tipped bumper guards. | 6. Roof moulding. (4 door sedan) | 9. Lower rear deck panel moulding. |
| 3. Wheel covers. | 7. Roof moulding. (2 door Sportsman) | 10. Stone shield. |
| 4. Sill mouldings. | | 11. Anodized aluminum insert. |

Optional Power Assists



TORQUEFLITE TRANSMISSION
Touch a button and De Soto's TorqueFlite transmission serves up the exact power wanted for every driving need.



CONSTANT CONTROL POWER STEERING
De Soto Power Steering, the most efficient on any car, gives a steady "feel" of the road. It works *full time*, too.



SAFE-STOP POWER BRAKES
New Safe-Stop power brakes make even sudden stops remarkably smooth. And they cut braking effort up to 80%!

6-WAY POWER SEAT
De Soto's six-position power seat moves forward, back, up, down, and tilts in or out from the wheel... all at the touch of a button.



POWER WINDOWS
There's a control panel at the driver's left that lets him open and close every window. Also independent controls at each window.

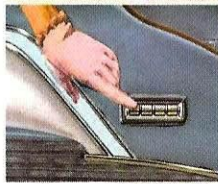

VISTA-VU POWER WINDOW CONTROL
Instrument panel switch and two rear window switches. Standard on 3-seat wagons, optional on 2-seat wagons.



SURE-GRIP DIFFERENTIAL
Minimizes the danger of getting stuck in snow, mud.

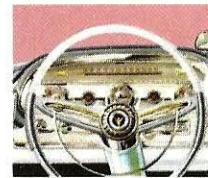

EASY-GRIP STEERING WHEEL
With "built-in" hand grips.

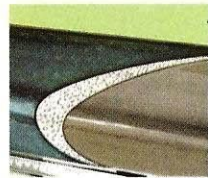

SAFETY PADDED DASH
Padded with absorbent polyurethane plastic foam.



VISTARAMA REAR WINDOW
For Firedome hardtops.



SOLEX GLASS
Subtly tinted, it protects your eyes from sun glare.



ELECTRIC CLOCK
An automatically self-adjusting precision clock.



REAR WINDOW DEFOGGER
Improves visibility.



2 PUSHBUTTON HEATERS
Choose Instant Comfort Heater or Auto-Temp.



DUAL-JET WINDSHIELD WASHERS
Automatic, toe-operated.

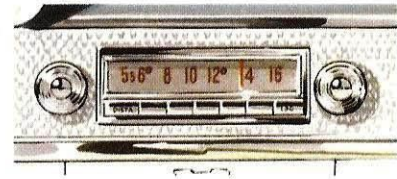

STATION SEEKER RADIO
Transistorized radio has toe-operated selector.



AUTOMATIC HEADLIGHT BEAM CHANGER
Raises and lowers your headlights automatically.

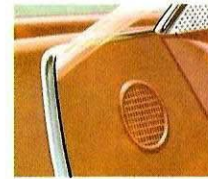

REAR SEAT SPEAKER
Teams up with the main speaker for a rich, true fidelity of sound.



TOUCH-TUNER RADIO
Transistor powered. Push-button operated.



TIRES AND WHEELS
White sidewall tires. Nylon cord tires. Oversize low-pressure tires. Captive-Air Nylon tires have reserve air chambers. If punctured, they can be driven up to 100 miles without repair. Deluxe wheel covers made of sparkling, rust-proof stainless steel.

OTHER USEFUL ACCESSORIES

- TRIAD HORN
- TINTED SUN VISORS
- VANITY MIRROR
- VARIABLE SPEED WIPERS
- DUAL EXHAUSTS
- GAS TANK LOCKING CAP
- CURB SIGNALS
- SEAT BELTS
- POWER ANTENNA
- DOOR EDGE PROTECTORS
- HANDBRAKE LIGHT
- TRUNK LIGHT
- ASH TRAY LIGHT
- GLOVE BOX AND MAP LIGHT
- SPOT LIGHTS
- UNDER HOOD LIGHT

1959 DE SOTO SPECIFICATIONS

FIREFLITE SERIES

ENGINE: 8-cylinder, 90 degree V. Valves inclined, in line overhead; intake valve diameter 2.08"; exhaust valve diameter 1.60"; bore and stroke, 4.250" x 3.375"; compression ratio 10.1 to 1; displacement 383 cu. in.; 4-barrel carburetor. Taxable hp 57.8. Premium fuel recommended.

TRANSMISSION: Standard equipment Torqueflite 3-speed fully automatic transmission, hydraulically actuated; combines torque converter with planetary gears; ratios: starting 2.45; drive range (low) 2.45; (second) 1.45; (direct) 1.00; (reverse) 2.20. Control by manually operated push-buttons (5) mounted on extreme left side of instrument panel.

LUBRICATION: Full pressure to main, connecting rod and camshaft bearings. Full-flow oil filter standard equipment.

COOLING: Full length water jacket, surrounds bores; 4-blade 18" diameter fan; water capacity 16 quarts (17 quarts with hot water heater).

DISTRIBUTOR: Single breaker type; mechanical and vacuum controlled automatic advance.

REAR AXLE: Silent-hypoid, semi-floating; ratio 3.31 performance (2.93 economy option).

Adventurer Engine: 8-cylinder, 90 degree V. Valves inclined, in line overhead; intake valve diameter 2.08"; exhaust valve diameter 1.60"; bore and stroke, 4.250" x 3.375"; compression ratio 10.1 to 1; displacement 383 cu. in.; two 4-barrel carburetors. Taxable hp 57.8. Premium fuel recommended.

Distributor: double breaker type; mechanical and vacuum controlled automatic advance.

Camshaft: special performance type.

FIREHOME SERIES

ENGINE: 8-cylinder, 90 degree V. Valves inclined, in line overhead; intake valve diameter 2.08"; exhaust valve diameter 1.60"; bore and stroke, 4.250" x 3.375"; compression ratio 10.1 to 1; displacement 383 cu. in.; 2-barrel carburetor. Taxable hp 57.8. Premium fuel recommended.

TRANSMISSION: Torqueflite 3-speed fully automatic transmission, hydraulically actuated; combines torque converter with planetary gears; ratios: starting 2.45; drive range (low) 2.45; (second) 1.45; (direct) 1.00; (reverse) 2.20. Control by manually operated push-buttons (5) mounted on extreme left side of instrument panel. Available at extra cost.

LUBRICATION: Full pressure to main, connecting rod and camshaft bearings. Full-flow oil filter standard equipment.

COOLING: Full-length water jacket, surrounds bores; 4-blade 18" diameter fan; water capacity 16 quarts (17 quarts with hot water heater).

DISTRIBUTOR: Single breaker type; mechanical and vacuum controlled automatic advance.

REAR AXLE: Silent-hypoid, semi-floating; ratio 3.31 performance (2.93 economy option).

FIRESWEEP SERIES

ENGINE: 8-cylinder, 90 degree V. Valves inclined, in line overhead; intake valve diameter 1.95"; exhaust valve diameter 1.60"; bore and stroke, 4.125" x 3.375"; compression ratio 10 to 1; displacement 361 cu. in.; 2-barrel carburetor standard equipment. Taxable hp 54.4. Premium fuel recommended.

TRANSMISSION: Standard equipment 3-speed manual shift; 3-speeds forward and 1 speed reverse; synchromount all helical gears; single plate dry-ventilated clutch; ratios: first 2.12; second 1.43; third 1.00; reverse 2.73. Special equipment Torqueflite fully automatic 3-speed transmission with pushbutton range selector (see Fireflite or Firehome specifications), or Powerflite fully automatic transmission, hydraulically actuated; combines torque converter with planetary gears; ratios: starting 1.72; drive range (low) 1.72; drive range (direct) 1.00; reverse 2.39. Control by manually operated pushbuttons (4) mounted on extreme left side of instrument panel.

LUBRICATION: Full pressure to main, connecting rod and camshaft bearings. Full-flow oil filter standard equipment.

COOLING: Full length water jacket, surrounds bores; 4-blade 18" diameter fan; water capacity 16 quarts (17 quarts with hot water heater).

DISTRIBUTOR: Single breaker type; mechanical and vacuum controlled automatic advance.

REAR AXLES: Silent-hypoid, semi-floating. Manual shift: performance ratio 3.54 (3.31 economy option). Powerflite ratio 3.31 performance (2.93 available on request). Torqueflite ratio 3.31 performance (2.93 economy option).