

*The Finest Fords of a Lifetime*



60

**FORDS**

GALAXIES • FAIRLANES • STARLINER • SUNLINER



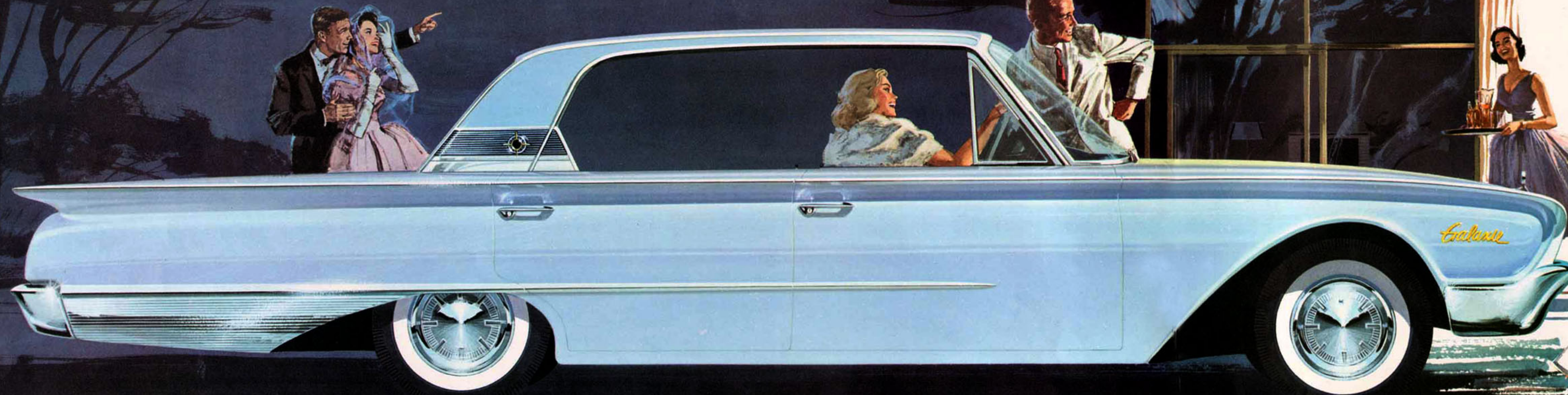

# 1960 brings a wonderful new world of FORDS

Inside this catalog you'll see the Finest Fords of a Lifetime! Economy-minded Fairlanes. Big-value Fairlane 500's. Elegant Galaxies. A breath-taking new Sunliner convertible and a brand-new hardtop model, the flashing Starliner.

**A wonderful new world of style.** There is a world of difference in the styling of these 1960 Fords. New hood contours are gracefully sloping to let you see better what's ahead. The Thunderbird-inspired roof protects you from broiling sun. This is *practical* styling combined with fine-car elegance.

**A wonderful new world of performance.** For the man of action, there are "hot and easy" new Thunderbird Special V-8's that blend blazing power with kid-glove smoothness. For the thrifty man, there's a new economy V-8 that gives even Ford's Mileage Maker Six a run for its money.

**A wonderful new world of ride.** You get a brand-new grip on any road with Ford's new Wide-Tread Design that gives you a full 5-foot tread. And leaf springs now 5 feet long have been designed into Ford's new rear suspension. Result: a car that moves like the Thunderbird, corners like the Thunderbird, rides like the Thunderbird—at low Ford prices!

*From any Point of View . . . from every Point of Value . . . truly these are the Finest Fords of a Lifetime!*

Color: Skymist Blue

Queen of the hardtops *Galaxie* Town Victoria

You get all the verve of a convertible, all the convenience of a 4-door, 6-passenger sedan in this glamorous Galaxie hardtop. With its Thunderbird-inspired roof that protects you from sun glare and heat . . . its vast picture-window views . . . its Thunderbird power and handling ease . . . here's all the automobile *anyone* could ask for! In fact, this beautiful Galaxie makes it unnecessary to pay more for *fine car elegance*.



# BUILT FOR PEOPLE . . .

*A Wonderful New World of Luxurious Comfort*

With all of its emphasis on elegant lines, the 1960 Fords have *not* sacrificed passenger comfort to achieve their beauty. In the Finest Fords of a Lifetime *six* big people—including the man in the middle—ride in greater comfort than ever. The new Fords give you nearly half-a-foot more shoulder room, more knee room, more hip room. Chair-high seats mean extra comfort, extra leg room. The “doglegs”—windshield supports that interfere with getting in and out of the front seat—have been eliminated in the 1960 Fords for your greater convenience.

As you step inside a 1960 Galaxie, for example, notice how your feet sink into the deep-pile 100% rayon Luxury Loom carpeting. Notice how you sit posture-perfect in

comfortably padded seats (foam padding does not cost you extra in a Ford). And the cushioned comfort extends the *full width* of the seats, too (no hard spots in the center)!

Now that you're seated comfortably, you can admire the luxury that surrounds you. For these are no ordinary car interiors . . . these are the finest, richest, most luxurious interiors ever seen in Ford's price class! Sofa-soft seats are covered with long-wearing upholsteries of exclusive nylon fabrics and sof-textured vinyl trim. Colors are blended harmoniously to please the most color-sensitive eyes. And in most models there's a smart touch of bright metal in each door and quarter panel. *Truly, you travel in the lap of luxury when you travel in a 1960 Ford!*

At the right is the color-keyed Luxury Lounge interior of a 1960 Ford Galaxie Town Victoria. When low Ford prices can buy this kind of elegance and luxury, why pay more?

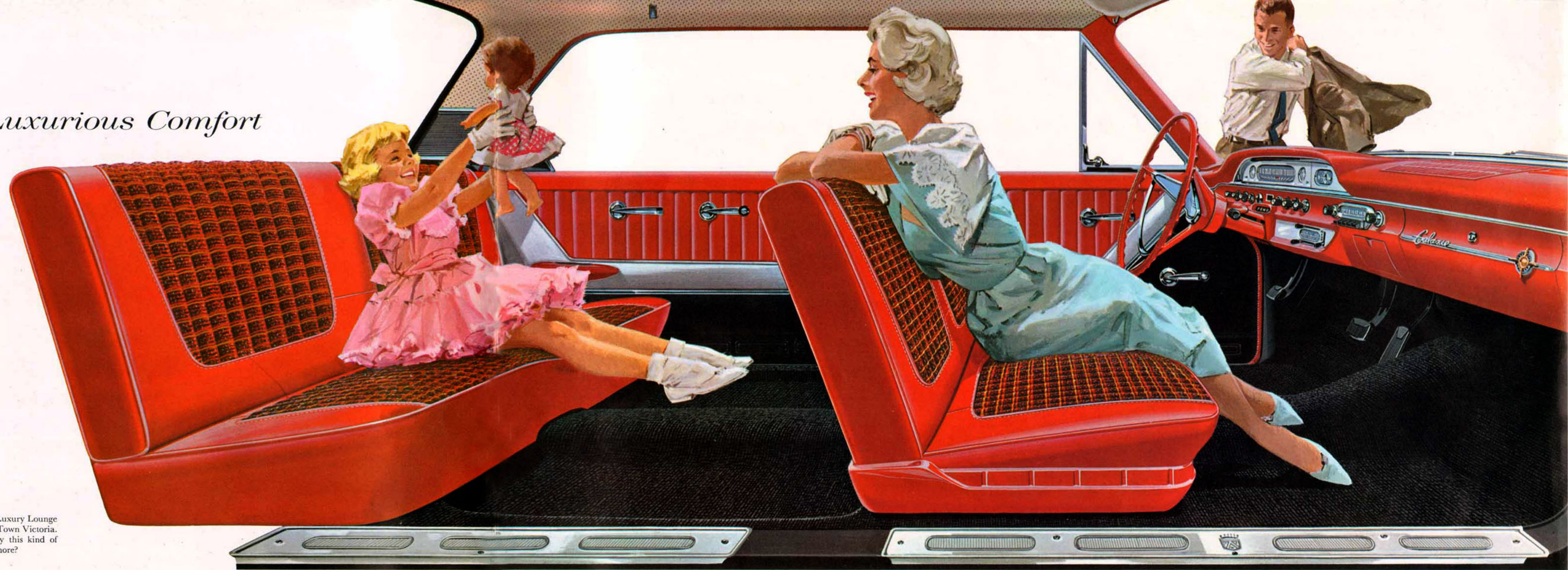



A Wonderful New World of Power

Expressed in motion

Starliner and Sunliner

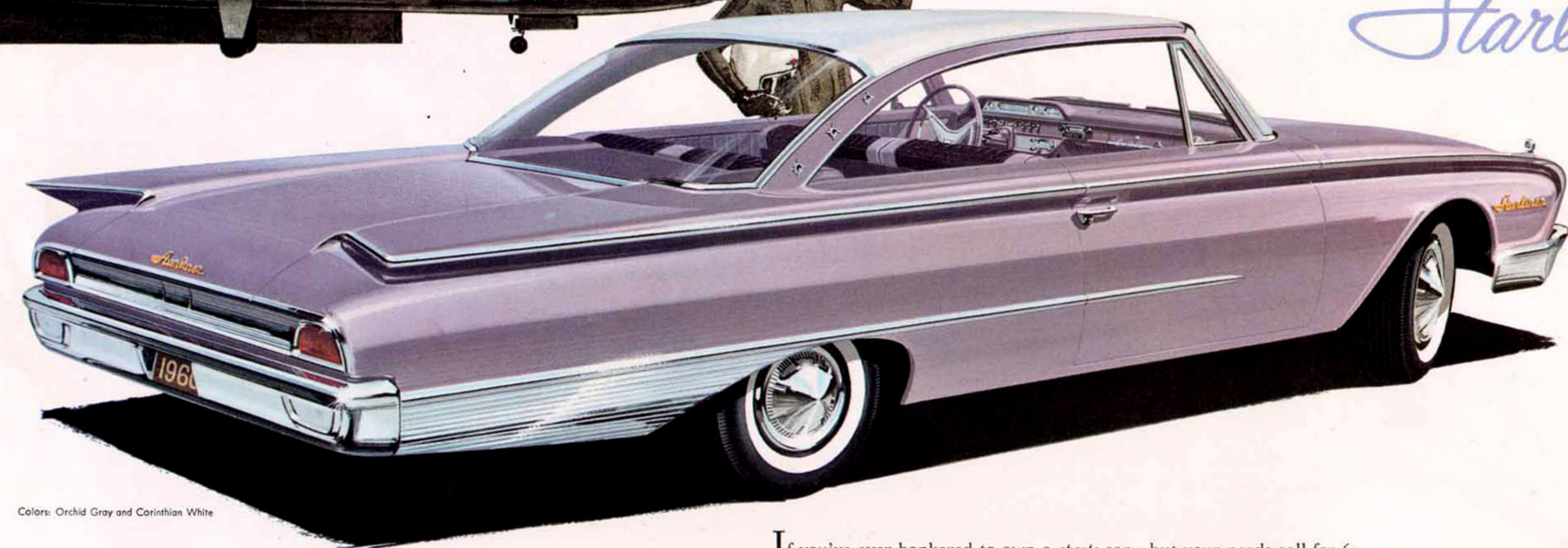
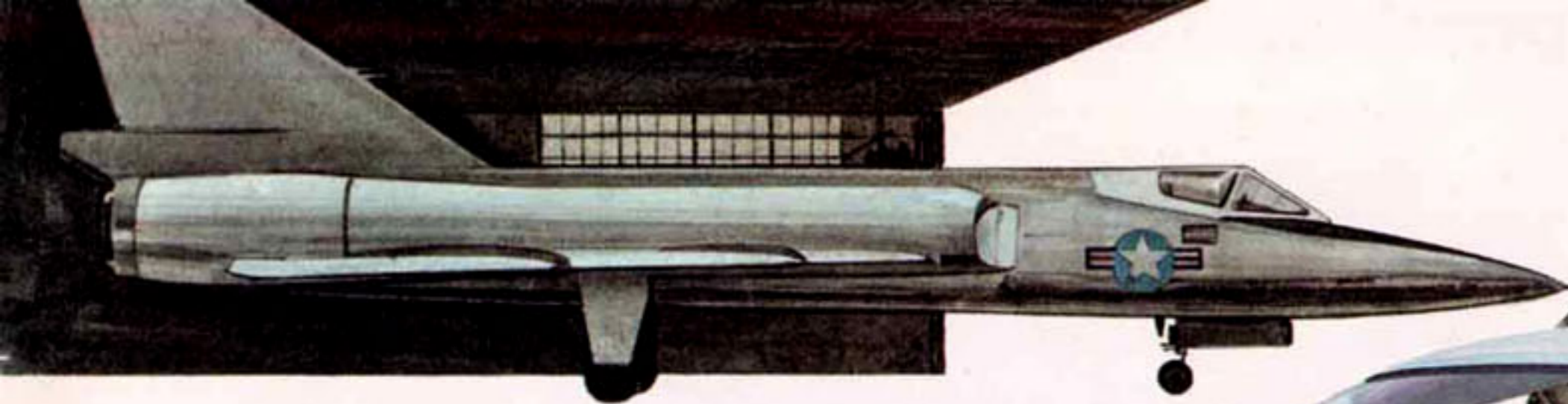

Colors: Orchid Gray and Corinthian White

If you've ever hankered to own a *sports* car—but your needs call for 6-passenger room—you'll know at first glance that this dashing, all-new Starliner was created for *you!* As your eyes drink in the beauty of this jaunty 2-door hardtop, you'll realize, too, that here is a beautifully proportioned motor car. Its flowing, swept-back lines give the Starliner a racy appearance that is daringly different, unmatched by any other full-sized car on the American Road today. And it's a car primed for *action*. Most Starliners are equipped with the optional Thunderbird 352 *Special* V-8 engine that gives you power *as you like it . . . when you need it!*

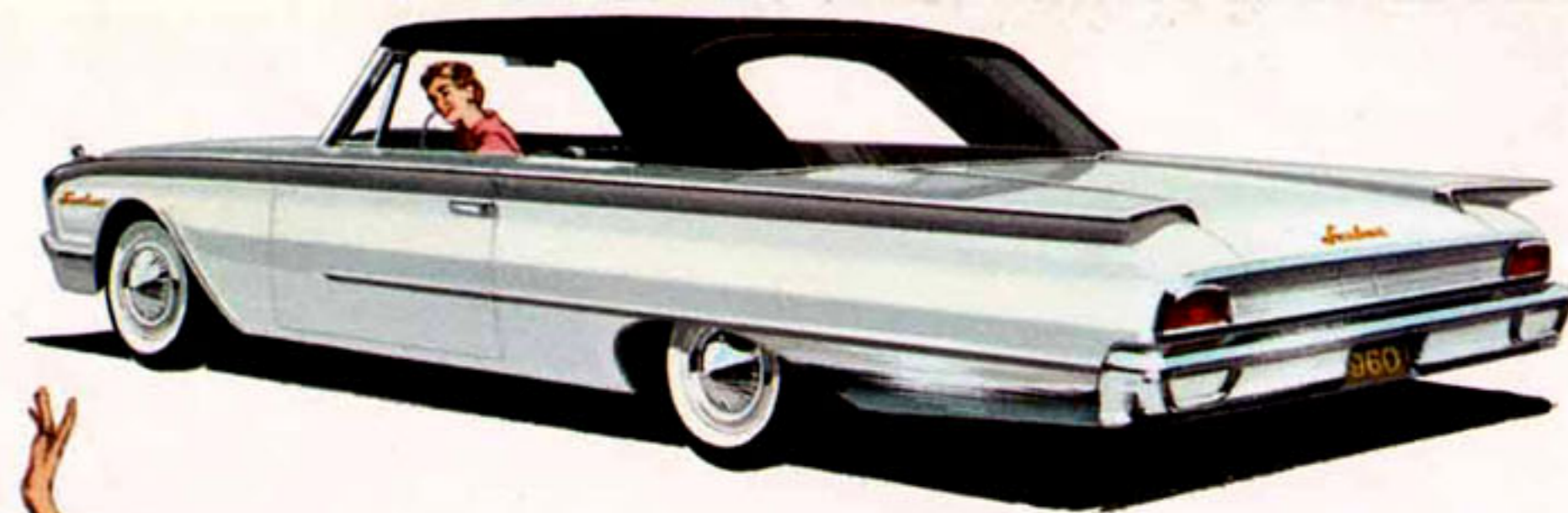

1960 Ford Sunliner with top up. Shown here in Corinthian White with black satin-grain vinyl top.



Color: Montecarlo Red

Here's a brand-new edition of the best-selling convertible of all time—the Ford Sunliner! Its sun-loving, fun-loving new proportions are a beauty to behold. And there's lively power to match the Sunliner's breezy looks. Most are equipped with the Thunderbird 352 *Special* V-8, the very same engine that propels the mighty Thunderbird itself. Hills surrender on sight! And notice the sleek-tailored new vinyl top. It not only stays brighter and cleans easier than others, but it folds down *completely flush* with the rear deck!



Wonderful New World of Elegance *Galaxie* Town and Club Sedans

Here are two of the most elegant, roomiest cars you've ever seen: 2-door and 4-door Galaxie sedans by Ford! Both of these cars provide unmatched comfort and leg room for six big adults. There's stretch-out room galore . . . and room for your hat, too. Under your feet is thick 100% rayon Luxury Loom carpeting. You'll be surrounded by the elegance of Ford's color-keyed Luxury Lounge interiors, now more beautiful than ever. You'll even be seated more comfortably in Ford's posture-perfect, chair-high seats!

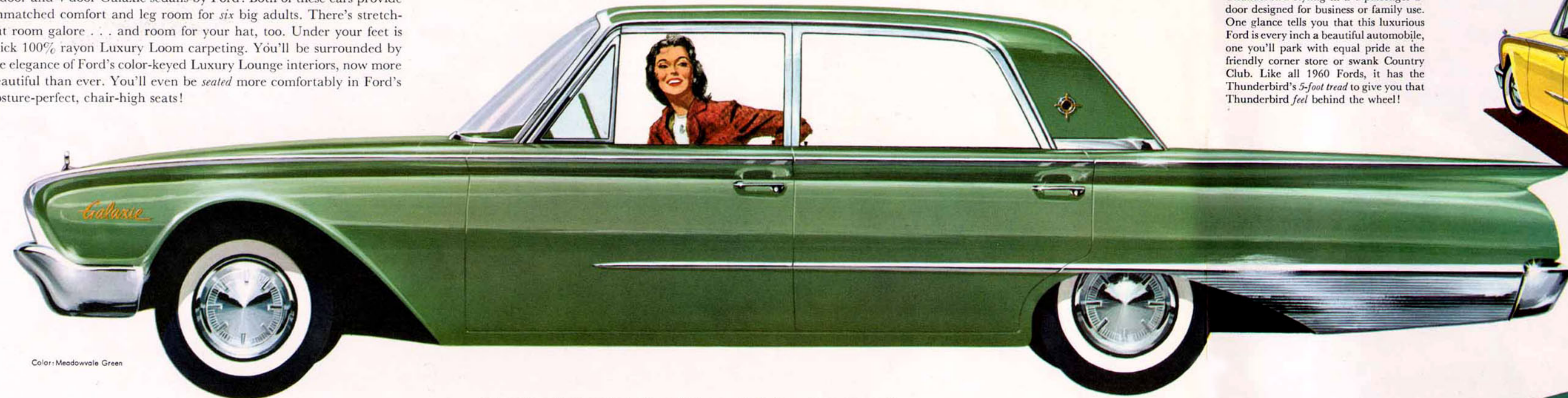

Color: Meadowvale Green

Galaxie Town Sedan (above) offers a big bonus of built-for-people comfort to all six passengers with its four wide-opening doors. Note the thin center pillar that gives this model the open look of a hardtop. When low Ford prices buy this kind of Thunderbird elegance, why pay high prices?

When it comes to getting in or out easily, no other car even comes close to the 4-door Galaxie Sedan with its big, wide-opening doors. As for safety, these cars, like all 1960 Fords, give you new *Truck Size brakes* with brake linings 25% bigger, the largest in Ford's field. The whole body is based on Ford's new *Wide-Contoured frame*. This new frame—25% stronger than ever before—gives the passenger compartment all-around protection other cars cannot even begin to match.

Luxury surrounds you (right) when you ride in a 1960 Ford. Yet Ford is designed with your comfort and safety in mind, too. You get up to 31% more total safety glass but *not* up into the roof where it invites discomfort from overhead sun glare and heat.

Galaxie Club Sedan (right) brings you Thunderbird styling in a 6-passenger 2-door designed for business or family use. One glance tells you that this luxurious Ford is every inch a beautiful automobile, one you'll park with equal pride at the friendly corner store or swank Country Club. Like all 1960 Fords, it has the Thunderbird's 5-foot tread to give you that Thunderbird feel behind the wheel!



Color: Yosemite Yellow





Fairlane 500 Club Sedan, shown here in Beachwood Brown, is the Value Leader of 2-door models for 1960. No other car can even come close to this big, beautifully proportioned Ford when it comes to downright value.

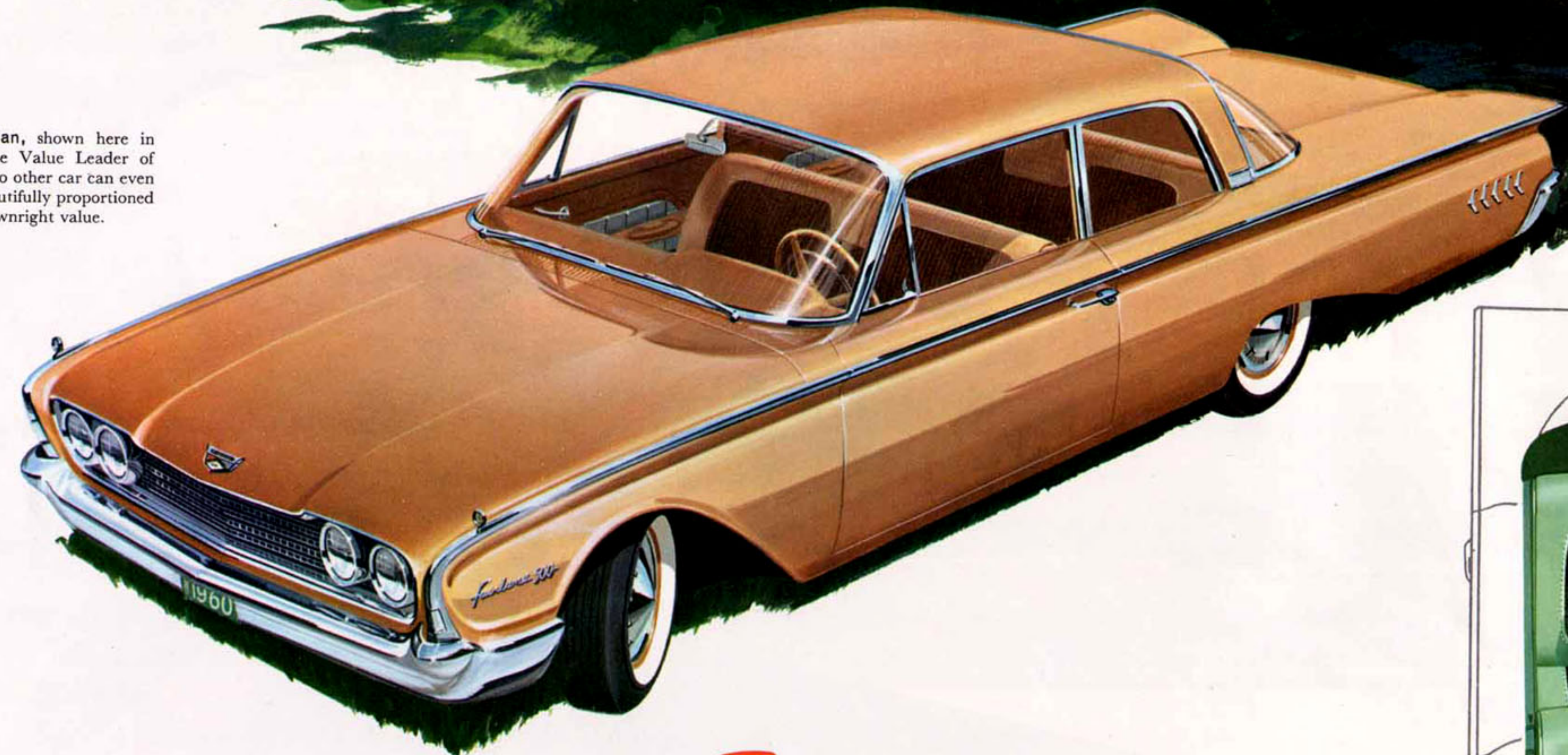

*Big Car Luxury at Ford's low price*

## *Fairlane 500 - Sedans*

You won't believe your eyes when you read the price tag on these beautiful Fairlane 500 sedans for 1960. Glamour and luxury have *never* been so low priced! Without question, these cars offer the greatest dollar value in cars today. Despite their low price, these Fairlane 500's bring you the *same* big six-passenger interiors and advanced features of

other 1960 Fords. You get the *same* Truck Size brakes . . . the *same* Wide-Tread Design . . . the *same* Thunderbird power . . . the *same* classic styling . . . the *same* low operating costs for which Ford is famous. From any Point of View . . . from every Point of Value . . . these cars are indeed the Value Leaders of the entire automotive industry for 1960. Drive one!



To the left you see one of four color-keyed Luxury Lounge interiors which you may choose in your 1960 Fairlane 500! Upholstery shown is green modern-stripe nylon cloth with morocco-grain vinyl bolster. Like all Ford interior materials, these have passed the most *rigid* tests in Ford's own laboratories. In the field of fashion the word "Ford" has long meant a "hit" —and it's true again in 1960!

Fairlane 500 Town Sedan, shown here in Aquamarine and Corinthian White, is the Value Leader of 4-door models for 1960. It's easy to pay a lot more money for a car . . . but it's impossible to find one that gives you so *much* for your money!



Wonderful New Economy in the beautiful *Fairlane*

Town Sedan/Club Sedan/Business Sedan

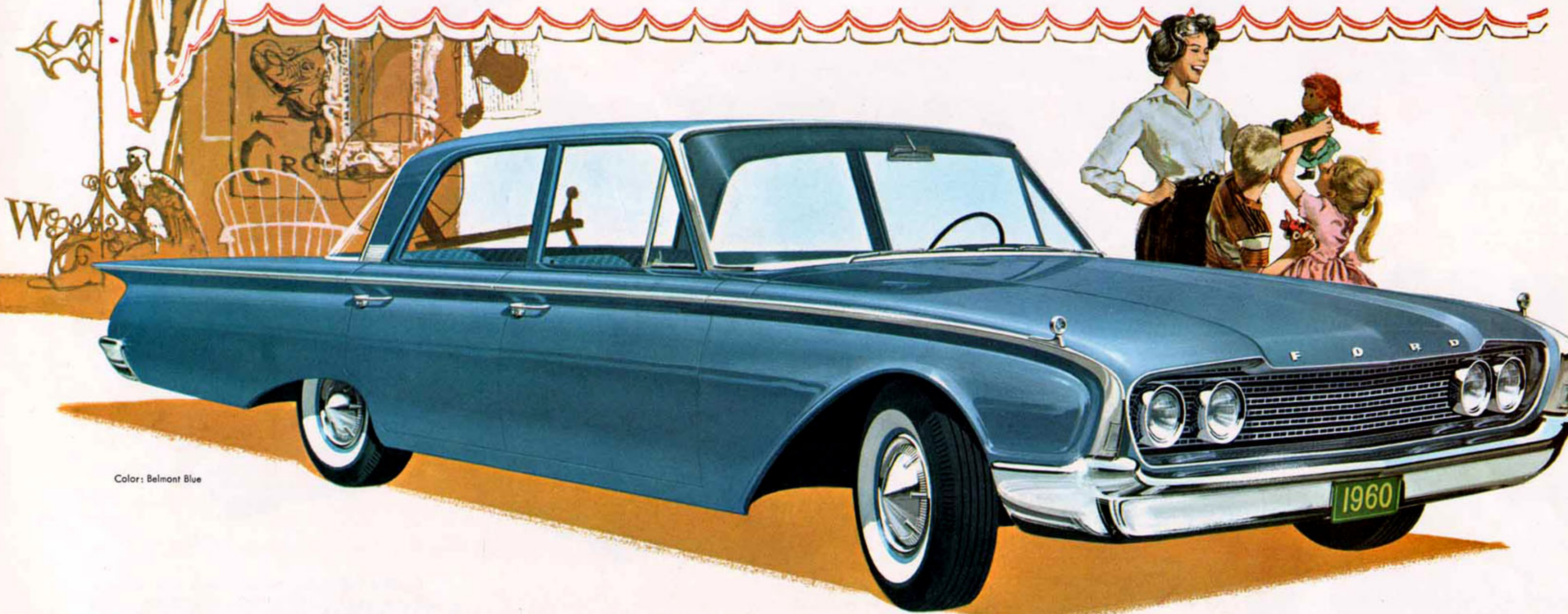

Color: Belmont Blue

The Ford *Fairlane* models for 1960 are the *lowest-priced* full-size cars you can buy. And like all Fords, your savings only *begin* with their low price. They continue every mile you drive. Save up to \$1.00 each time you fill the gas tank, for Ford's standard engines thrive on regular fuel. Save on aluminized mufflers that normally last *twice* as long as ordinary kinds . . . save on oil changes that now are needed

only each 4,000 miles . . . and save on Ford's Diamond Lustre Finish that never needs waxing. Such features have made lower-priced Fords the sales leader by a margin of nearly 2-1 over competition! And now, while *remaining* lowest priced, these cars have moved up to Fairlane class in size, style, comfort and performance. No wonder they're the *money-savingest full-size cars you can buy!*

Fairlane Town Sedan offers the convenience of a 4-door, the savings of a Fairlane, and it's still one of America's lowest-priced full-size cars. If you want a big 6-passenger car at a modest price—whether for business or family use—this model fills the bill beautifully. Equipped with either the Mileage Maker Six or the new standard Thunderbird 292 V-8, you'll find it one of the thriftiest new models to own.



Color: Montecarlo Red

Fairlane Club Sedan (left) is one of the *lowest-priced*, full-size, 2-door family sedans in America. Seating six adults in roomy comfort, this car is designed for families requiring dependable performance within a budget. Its special Fairlane features include "hardtop" styling, made possible by Ford's thin-pillar design and vast picture-window views. This Fairlane is one of the biggest selling models, and it's easy to see why!



Business Sedan brings you all of those features that have made the 1960 Fairlanes world famous for economy, yet it meets the needs of businessmen who require easily accessible space for luggage and samples. The space back of the seat is 33" x 64", plus a big trunk that holds 33½-cu. ft. Something else the traveling man will appreciate is the comfortable seat that's *foam padded* at no extra cost. It's adjustable to 11 different positions.

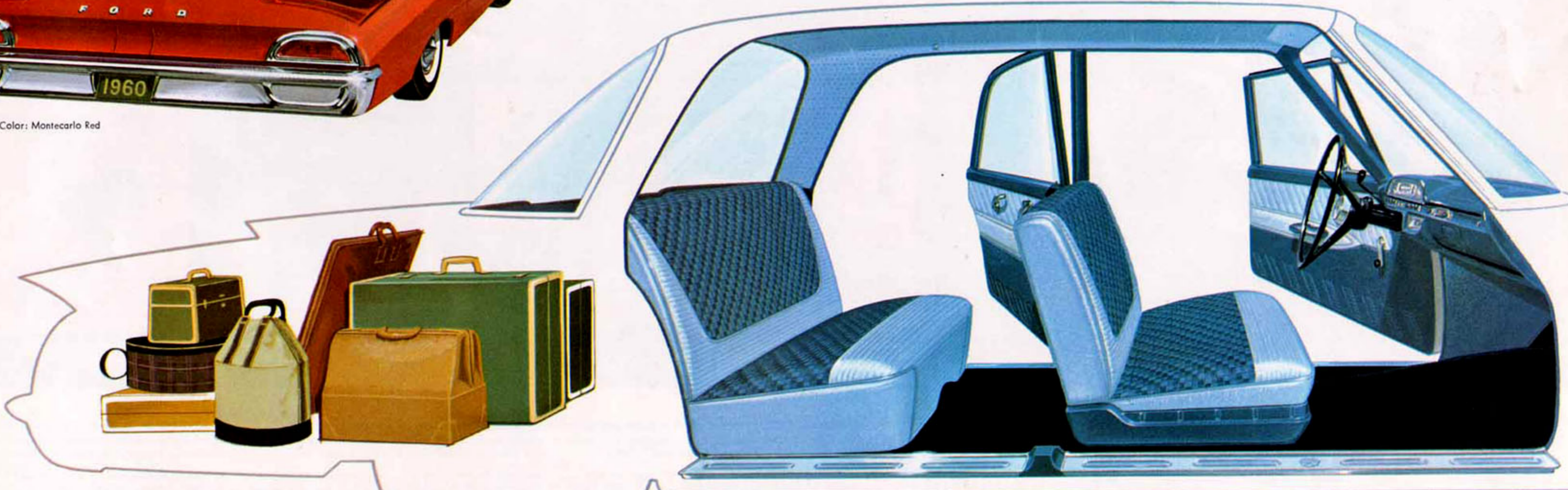

Beautiful as they are, the interiors of Ford's 1960 Fairlane models are mighty practical, too. They resist normal wear and tear in a manner that belies their elegance, and they are surprisingly

resistant to hard usage by small children. Before *any* material can be placed in a Ford interior, it first must meet the most rigid standards in the automobile industry in Ford's own testing laboratory.



60  
**FORD**  
OPTIONS  
AND  
ACCESSORIES



**POLARAIRE CONDITIONER** brings coolest comfort no matter how hot the weather. Ford air conditioning is priced lower than on competitive cars. In fact, an air-conditioned Ford costs less than many medium-priced cars without air conditioning. This unit has larger capacity and dehumidifies as it cools for maximum comfort. (Six and V-8's.)



**CONSOLE RANGE RADIO** has increased power output for 1960 to bring in truer reproduction of distant stations. Transistor powered yet moderately priced, this Ford radio has automatic push-button tuning to give you a choice of five pre-set stations.



**REAR BUMPER REFLECTOR AND BACKUP LIGHT** are completely new for 1960. Reflector doubles the size of taillight glow. Circular backup lights are mounted in lower back panel, one on each side.



**NEW HOOD ORNAMENT** adds a modern touch that is the crowning glory of Ford's classic design for 1960. It's made from corrosion-resistant metal to stay bright.



**4-WAY MANUAL TILT FRONT SEAT** is an easily operated, modestly priced mechanism that gives you a choice of 55 different seat positions. Any driver—tall or short, thin or fat—can be seated comfortably for greater driving ease and safety.



POWER STEERING

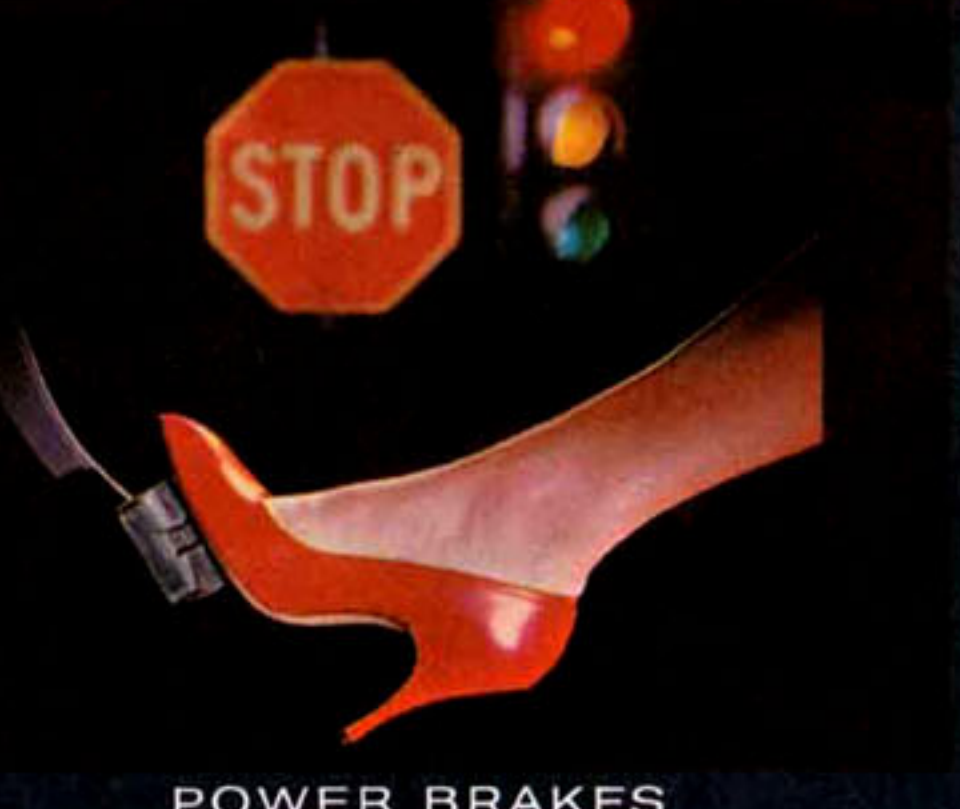

POWER BRAKES

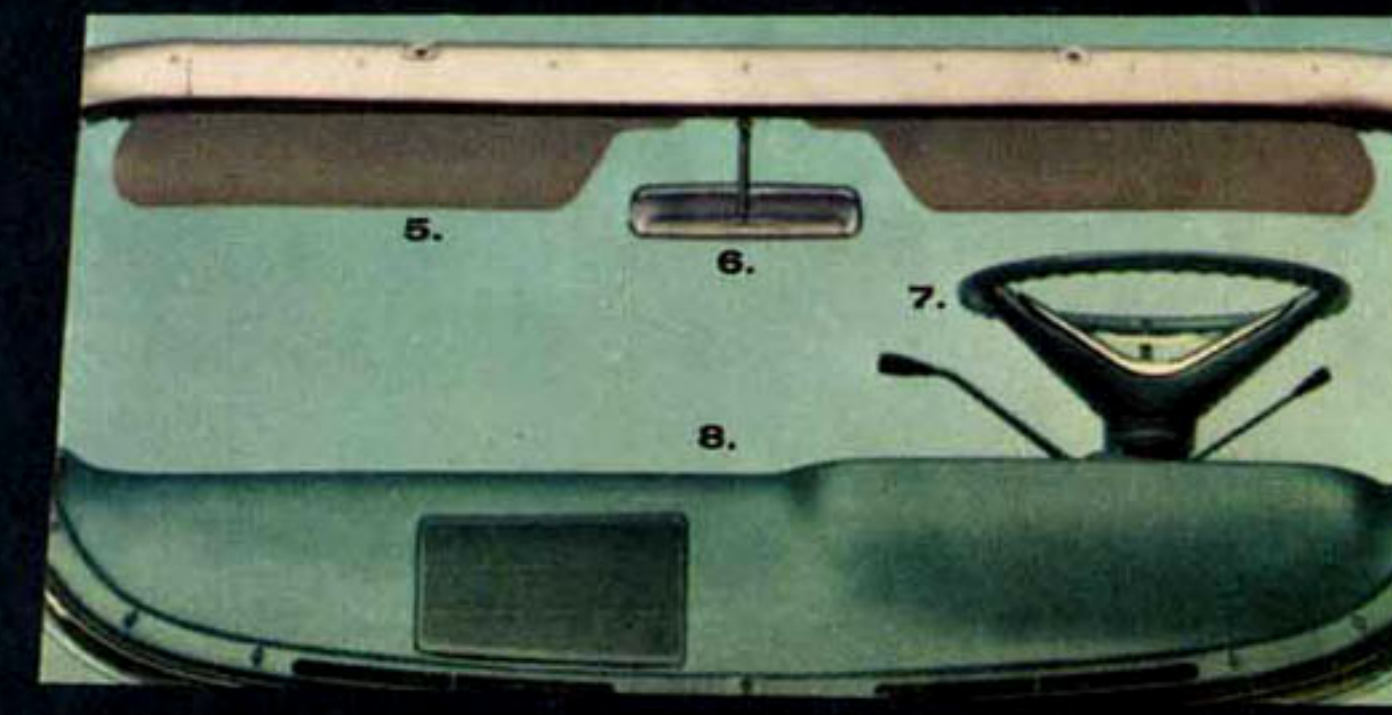

**SAFETY**

Ford's Lifeguard Design saves lives and reduces injuries. For 1960 Ford offers: 1. Lifeguard arm rests fully cushioned with shock-absorbing material. 2. Seat belts help keep you in your seat in case of impact.\* 3. Lifeguard Jr. safety locks help prevent "small fry" from accidentally opening a rear door.\* 4. Lifeguard Double-Grip door locks for added protection against doors springing open upon impact. 5. Lifeguard sun visors fully cushioned with super shock-absorbing material.\* 6. Lifeguard double-swivel shatter-resistant safety mirror swings away if struck. 7. Lifeguard deep-center steering wheel with three equally spaced spokes. 8. Lifeguard cushioning on instrument panel.\*

\*Optional at modest extra cost



**REARVIEW MIRROR** is a must for safe driving. Ford offers five types, including an Adjust-O-Ring with special ring visor that helps protect against rain, snow and mud.



**SPORT SPARE WHEEL CARRIER** gives your Ford that sophisticated appearance for still greater distinction. It adds an impressive 10 inches to your car's length; leaves more luggage space inside trunk. Decorative tread cover is stainless steel.



**SELECTAIRE CONDITIONER** gives you complete climate control the year-round with dehumidified cooling, ventilating, heating and defrosting in one compact unit, yet it's priced lower than units of this type on other cars. Capacity has been boosted for 1960 for still faster warm-up or cool-down. (V-8's only.)



**VISORED SPOTLIGHT WITH MIRROR** gives night-and-day convenience. Visor feature makes it effective in nearly all weather. And it is easily adjusted from inside car.



**MAGICAIRE HEATER** gives heating, ventilating and defrosting in one dependable unit. Pulls in fresh outside air thru cowl top. New greater capacity with quick warm-up door for cold mornings.

**CLOCK** is self-regulating electric type which re-times itself automatically each time you set it. Newly styled face has illuminated dial and full-sweep second hand. ▲

**WHEEL COVERS** of bright metal make the whole car glitter. These are smart, full wheel covers featuring an ultra-modern Sun Dial design.

**INSIDE MIRROR** is non-glare type, ten inches wide. It turns off the blinding glare of headlights behind you with a flick of your finger.



POWER WINDOWS

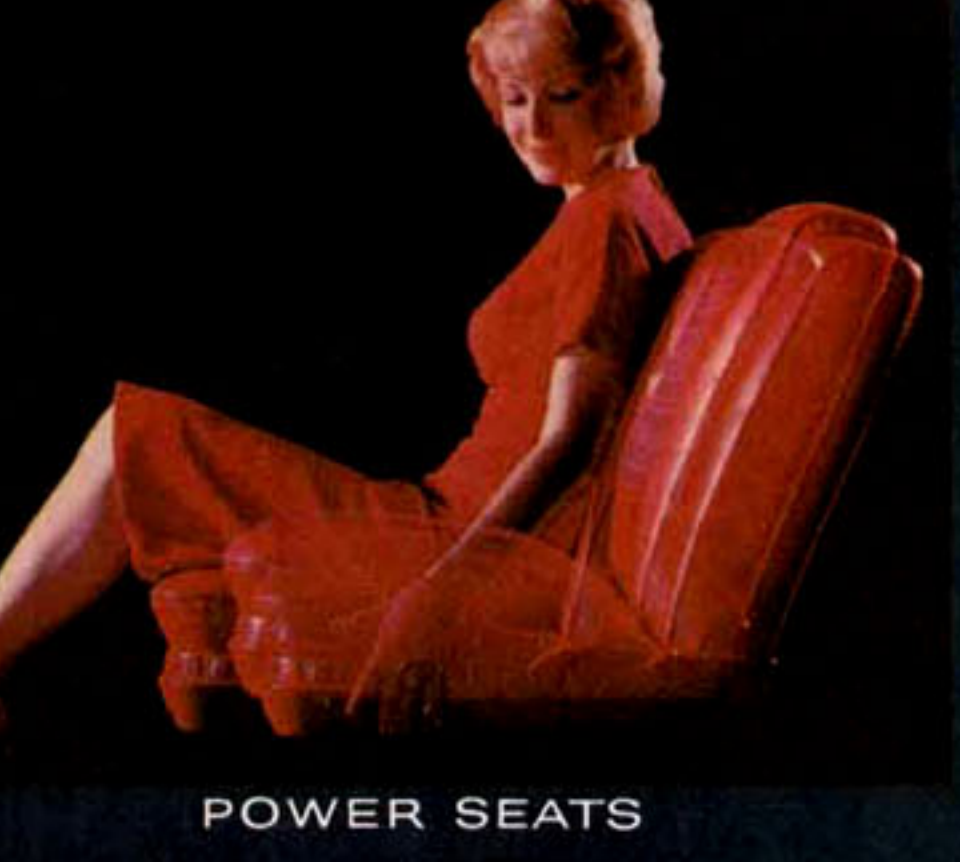

POWER SEATS

**POWER ASSISTS**

**PLUS**

- ANTENNA, FRONT
- CAR MATS, CONTOUR (front, rear and twin front)
- CIGAR LIGHTER ▲
- REAR FENDER SHIELD
- LICENSE PLATE FRAME
- LOCKING GAS CAP
- SEAT COVERS
- VENTILATED SEAT CUSHIONS
- TISSUE DISPENSER
- VANITY MIRROR

▲ Standard on Galaxies, Starliner and Sunliner

**WINDSHIELD WASHER** has twin nozzles activated by a floor foot pedal. Features larger capacity and increased pressure for safer cleaning while driving at high speeds.

**ELECTRIC WINDSHIELD WIPERS** have positive wiper action which is unaffected by changing engine speed for they are operated by their own electric motor. 2 speeds.

**I-REST TINTED GLASS** is available for all windows of all models, except the back window of the convertible. It is green tinted, with blue-gray band on upper windshield.

**FULL TONE MANUAL RADIO** is transistor powered; brings in distant stations with ease. Excellent tone quality. This is a quality radio in every way; moderately priced.

**ANTENNA, REAR FIN MOUNTED** is swept-back type and comes for either single or dual installation. With dual mountings, only one antenna is connected to radio.

**REAR SEAT SPEAKER** is a big 6" x 9" speaker with a new grille. Three-way control tunes in front or rear speakers only, or both speakers in synchronization.

**DECK LID RELEASE** allows driver to unlock rear deck lid without leaving car, simply by pulling the bright-metal release handle on floor. Handy for checking air in spare tire.

**PARKING BRAKE SIGNAL** provides a warning light that flashes steadily so you can't miss its message that your parking brake has not been properly released.

**WHEEL TRIM RING** is used with hubcaps to provide a look similar to a full wheel cover. Made entirely of bright metal, it is attached around outer circle of wheel.

**ROCKER PANEL TRIM** is the new stainless steel ribbed-type. It runs along the rocker panel from the front to the rear wheel opening and provides lower body protection.

**REAR FENDER SHIELD** is the all-new flush-type that is becoming so popular. It has been designed to conform to the new wheel opening. Skirt is "lipped" along bottom.

**FRONT BUMPER GUARDS** are all-new, incorporating a vertical, textured black rubber insert. Located over outer extremities of bumper, they protect parking lamps.

**REAR BUMPER GUARDS** are all-new with a vertical, textured rubber insert. Located on top surface of bumper below each taillight, they give vital protection.

**EXHAUST DEFLECTORS** are all-new and bright die cast for 1960. Attached directly below the bumper reflector ornament, they add a smart finishing touch to the rear.

**EQUA-LOCK DIFFERENTIAL** delivers the driving force equally to both rear wheels. Both wheels turn at the same speed instead of one spinning and the other standing still.

**RECIRCULATING HEATER & DEFROSTER** provides abundant, economical heating and defrosting at low cost. Recirculates passenger compartment air; has dual outlets.

You'll never use muscle power again when you equip your 1960 Ford with these power assists that do all the work for you: *Master-Guide Power Steering* cuts your parking effort up to 85% and assists you in all your driving. *Swift Sure Power Brakes* with a low pedal are the brakes you love to touch. Stopping takes up to 45% less effort; makes driving in traffic

much easier. *Power-Lift Windows* let you touch the central control button on the driver's door and raise or lower any window. There's a handy button under each window, too. *Power Front Seat* is an infinite position, posture-control seat with synchronized tilting back. All power assists are optional at extra cost.



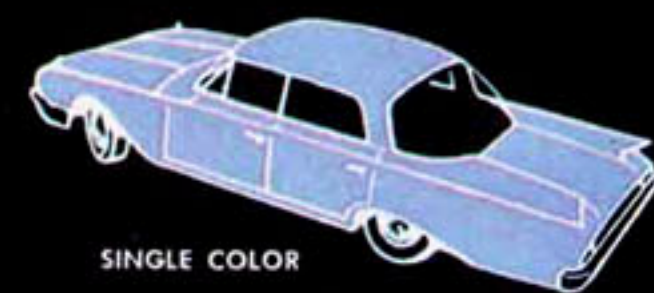

SINGLE COLOR



TWO-TONE COLORS

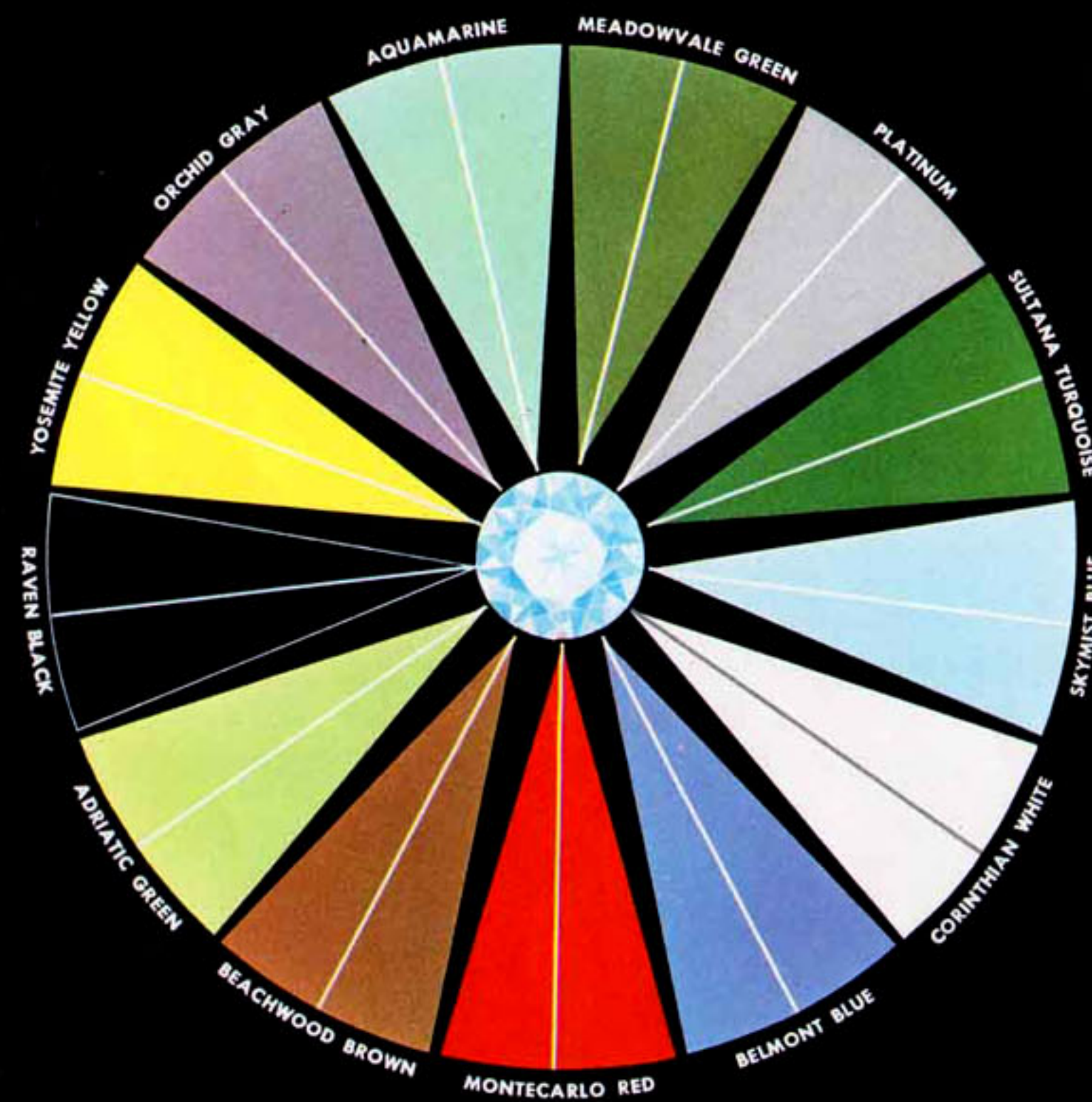

SUNLINER



STARLINER AND GALAXIE VICTORIA



GALAXIE SEDAN

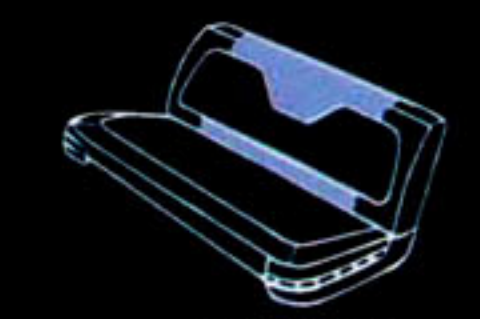

FAIRLANE 500



FAIRLANE

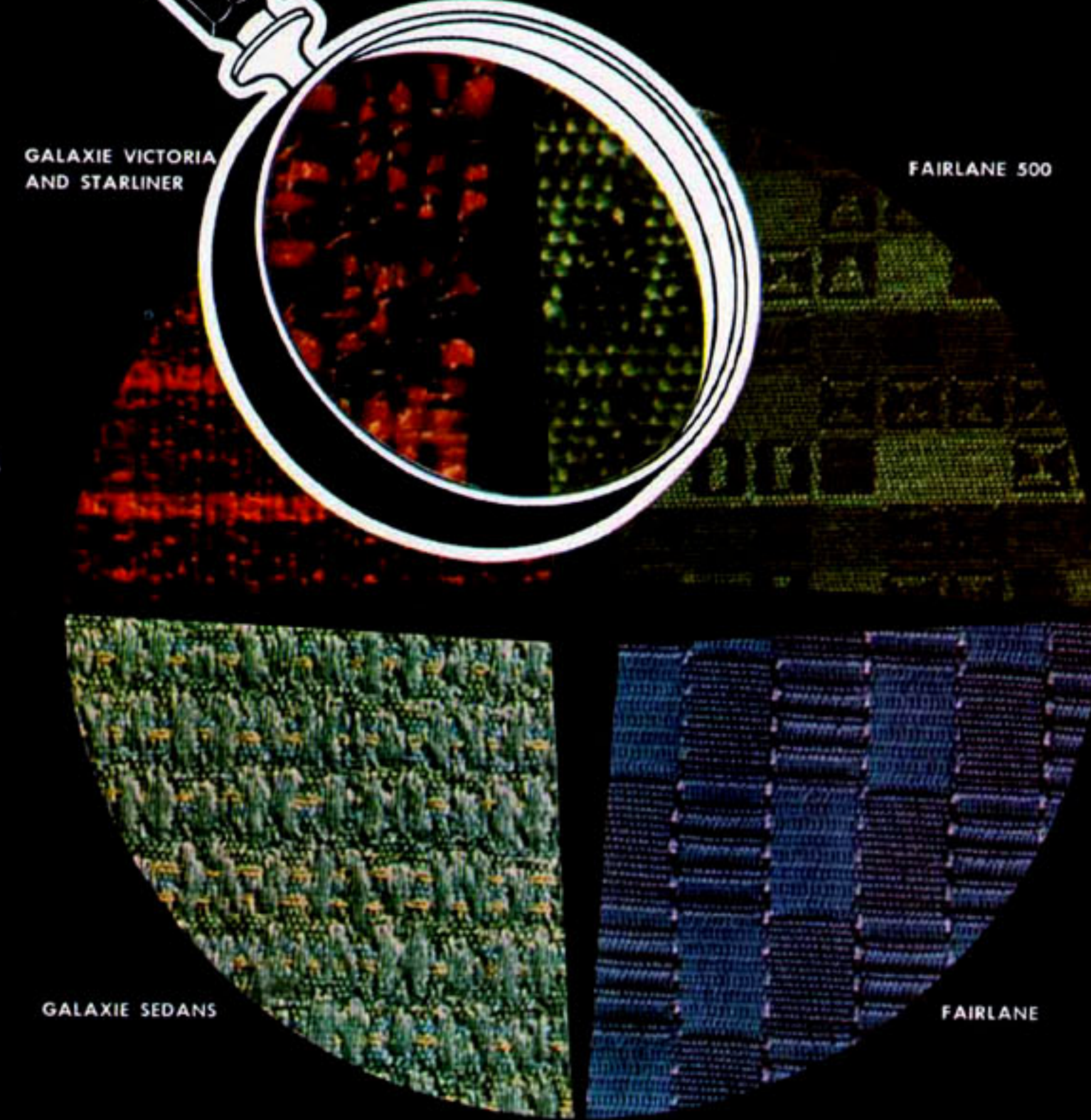

# EXCLUSIVELY FORD...

## Diamond Lustré Finish in new vibrant colors

Above all in these beautifully proportioned 1960 Fords is the sparkling Diamond Lustré Finish! Its uniform, glass-like surface requires no "hand-finishing" to bring out its natural, deep-down lustre. And it's so bright and hard and glossy that you won't have to wax it ever!

The superiority of this longer-lasting, baked-on Ford enamel was proved first in laboratory torture tests. It was tested further by desert sun and salt air. Through it all Diamond Lustré Finish proved its toughness. Take your pick of the vibrant colors shown on this color wheel!

## More beautiful than ever...Luxury Lounge interiors

The glamorous Luxury Lounge interiors of the 1960 Fords are as durable as they are beautiful. Upholsteries are nylon, trimmed with radiant and soft-textured morocco-grain vinyls. Because the radiant vinyl is less porous, dirt cannot penetrate easily; it cleans more quickly!

Floor coverings in Galaxie models are color-keyed 100% rayon carpeting throughout. Fairlane 500 models have color-keyed Vinyl-Tex which looks like carpeting, wears like vinyl. Fairlanes have Sof-Tred carpet-textured rubber. Choose the one that suits you best!

READ THESE FACTS AND YOU'LL AGREE:

# WHY FORD?...

*From any Point of View ...  
From every Point of Value ...  
These are the Finest Fords  
of a Lifetime!*





the 60  
here's why **FORDS** give more **COMFORT**



**C**hair-high seats, with plenty of room for your hat

Ford's comfortable, chair-high seats are inches higher than those of some competitive cars. You never get the feeling that you're seated on the floor! And Ford seat backs are positioned at a posture-perfect 23-degree angle for real living room comfort. This is a feature you'll appreciate on long drives. And above all, there's plenty of room for your hat.

**M**ore stretch-out room . . .  
**N**o hard spots in center seats

You've got more room to relax in a 1960 Ford. Seats are much wider for full seating comfort of six adult passengers. There's more room for shoulders, more room for hips . . . knees . . . legs . . . feet . . . more room for everything. Ford's tunnel for 1960 is narrower than the tunnel of some competitive cars. This means more foot room . . . more all-around comfort for the passenger seated in the middle. And Ford seats are so thick, so well padded that there's no hard spot in the center, either.

**F**oam padding gives more comfort . . . costs nothing extra

One thing you'll really appreciate is the comfort of a Ford seat, especially on long trips. It's durable because Ford uses only the best fabrics and vinyls in their eye-pleasing upholstery combinations. It's comfortable because it's foam padded—at no extra cost. And the seat is adjustable to 11 different positions on a track that travels nearly half a foot. Whether you're tall or short, it's easy to find a comfortable setting.

the 60  
here's why **FORDS** give more **CONVENIENCE**

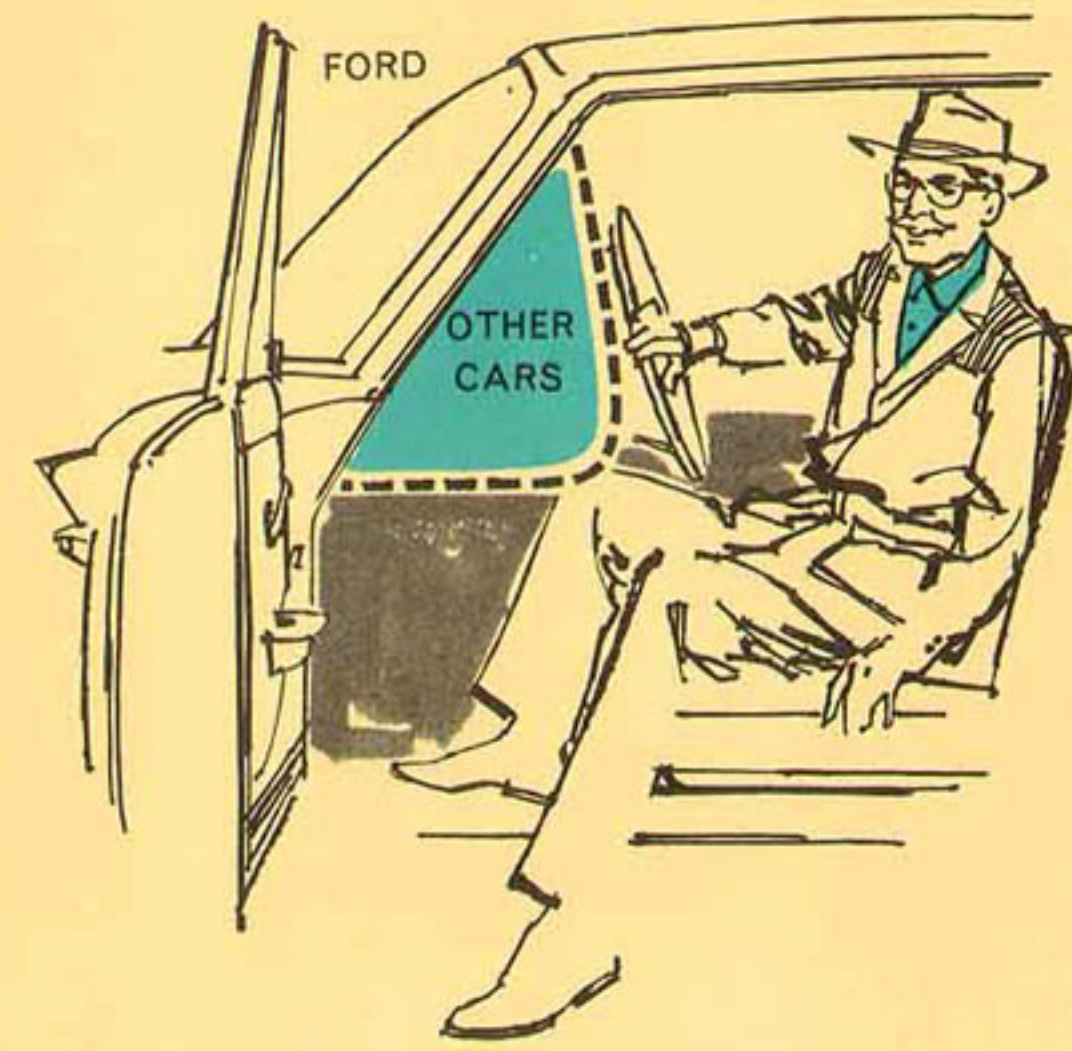

**F**ord eliminated the "dogleg" to save your knees

No more bruised knees (or ruined hosiery!) when you get into or out of a 1960 Ford. Ford has eliminated that annoying windshield extension or "dogleg" still found in the pillar design of so many other cars, without sacrificing visibility. Ford gives you far larger doors for more entrance and exit room, too. In short, you don't have to be a human corkscrew to get into or out of a 1960 Ford!

**F**ord's 2-position door checks hold doors full or 2/3 open

Depend on Ford to be first in bringing you luxury-car features . . . at low Ford prices. 2-position door checks, for example, hold Ford's wide-opening front doors two-thirds or all the way open. It's an especially convenient feature when you've been shopping and have an armload of packages. On 4-door models, Ford's "Automatic Doorman" helps you swing open the rear doors. Still another convenience is a foot-operated parking brake that you set with a touch of your toe.

**F**ord's trunk allows easy-lift loading

You don't need a jack in order to lift luggage high enough to place it in the trunk of a 1960 Ford. Ford's low-level trunk entrance is only 27 inches above street level to make loading far easier . . . safer, too. And the torsion bar hinged trunk lid is counterbalanced for still greater convenience. Spare tire is out of the way. As for room, you can load in 3 weeks' vacation luggage with ease.



here's why **the 60 FORDS** mean more **SAVINGS**



ORDINARY MUFFLER  
AFTER 12 MONTHS

FORD MUFFLER  
AFTER 12 MONTHS

here's why **the 60 FORDS** deliver more **PERFORMANCE**

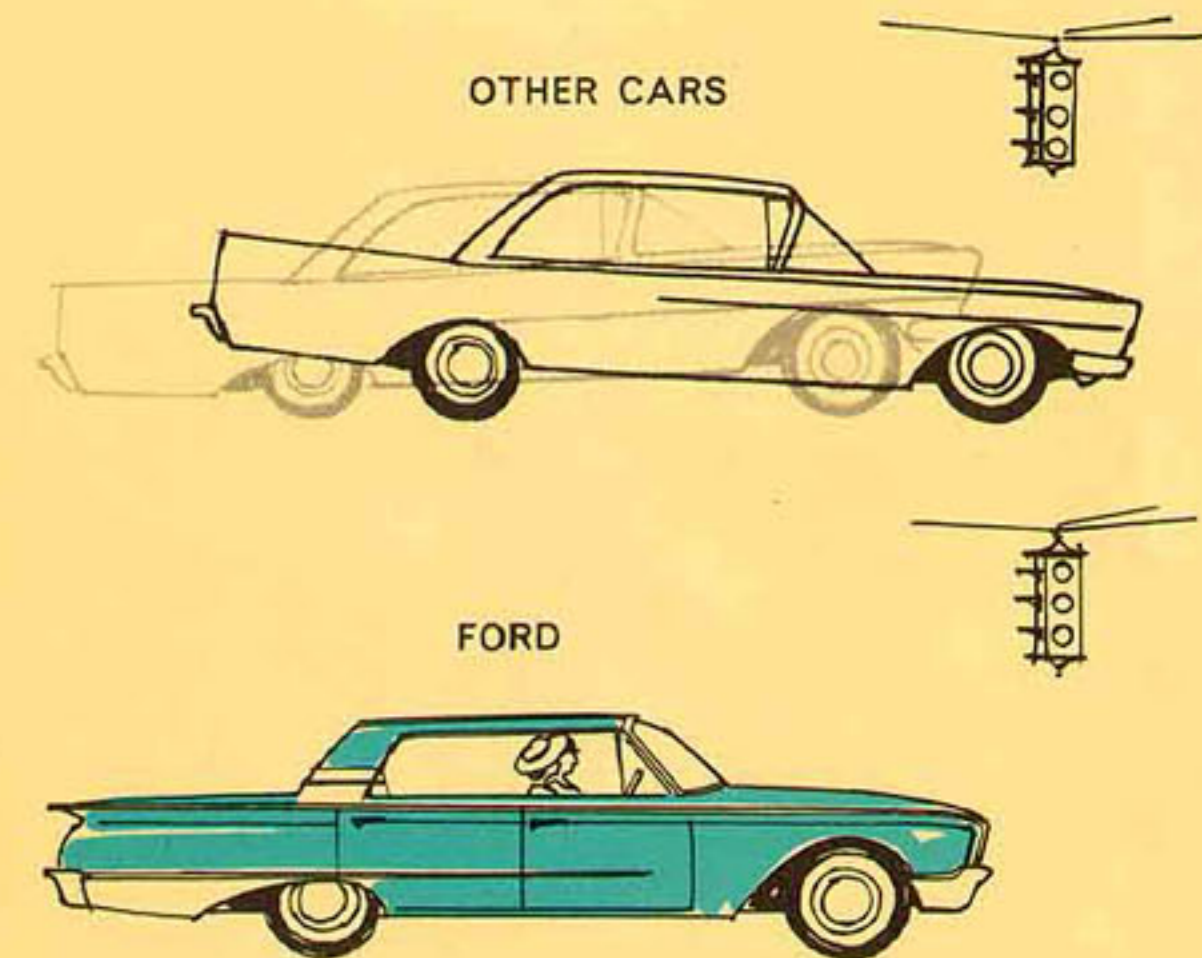
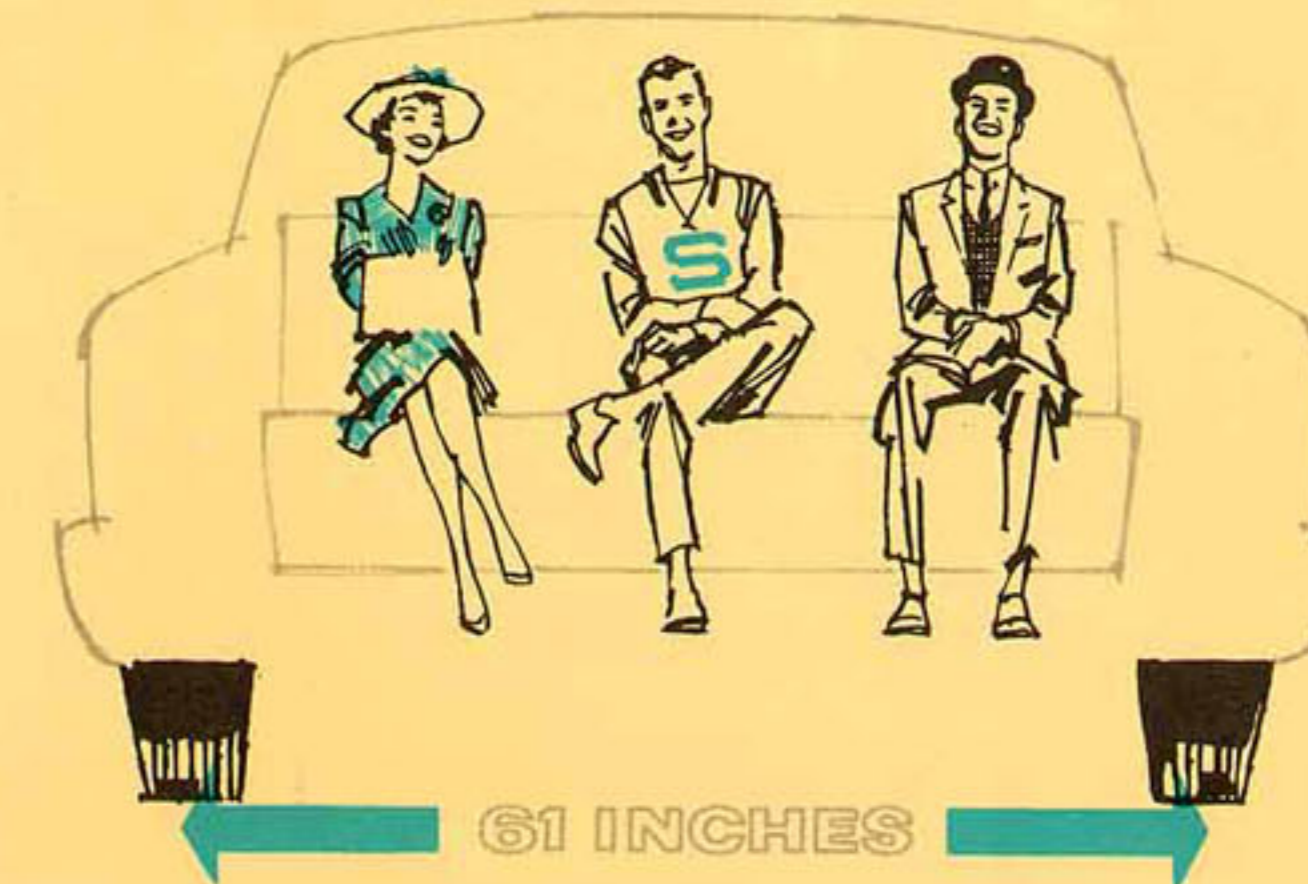
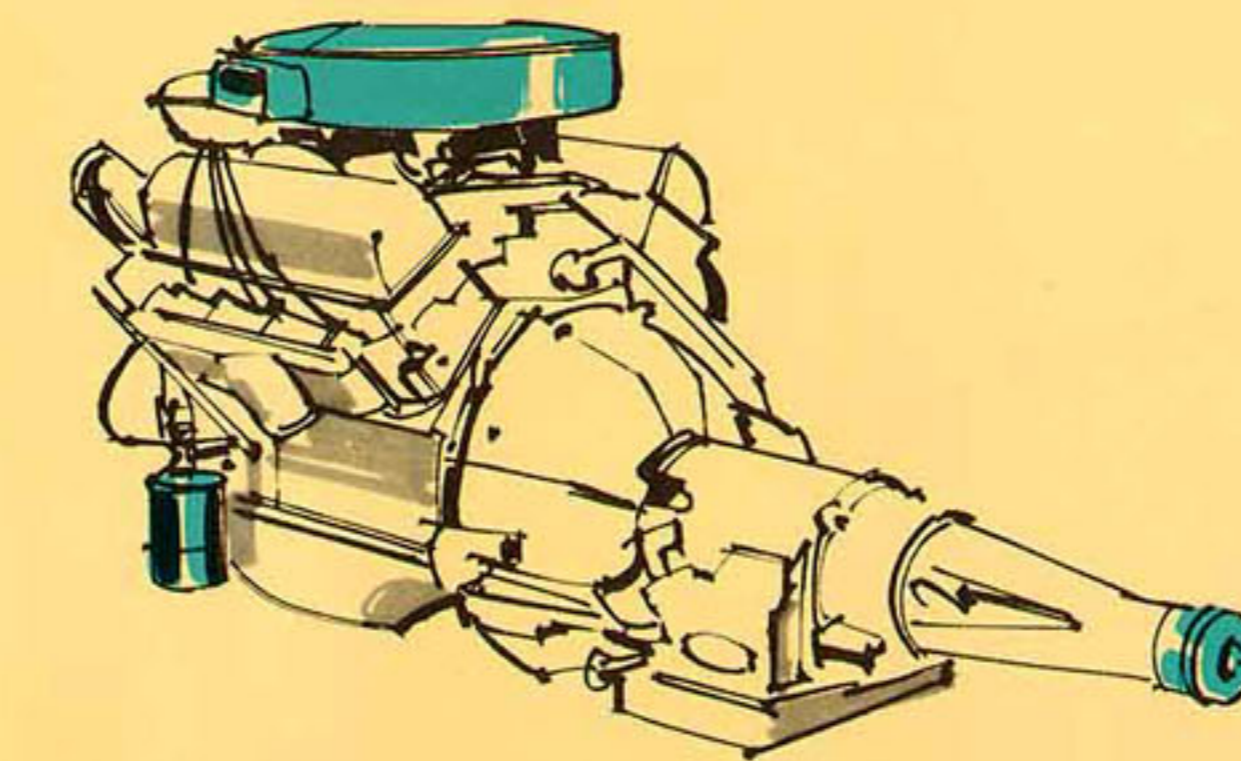

**G**reater stability with new **WIDE-TREAD DESIGN**

**N**o squat . . .  
**N**o dive with **NEW REAR SUSPENSION**

**Y**ou pay only a low Ford price for big-car size and features

**F**ord standard engines use regular gas; save up to \$1.00 every tankful

**F**ord aluminized mufflers normally last twice as long as ordinary kinds

**L**ively T-bird engines are teamed with four great transmissions

All 1960 Fords now give you the Thunderbird's own kind of road-hugging ride with their new Wide-Tread Design. Both front and rear wheels now are five feet apart. New rear leaf springs are five feet long. You get a 5 x 5 ride! You get better roadability, steadier control and a new feeling of security on curves. For the first time here's a car that corners, rides and handles like the Thunderbird—at low Ford prices!

Ford gives you both anti-dive control and anti-squat control, too. Softer rear leaf springs are five feet long. With rear axle located well forward from center of springs, you get a new levelized, variable-rate rear suspension that dampens out bumps and keeps your ride far smoother than is ever possible with coil-type rear springs.

It is now a legal requirement that every car have its suggested list price posted clearly. This makes it easier than ever to compare low Ford prices with those of other cars in Ford's class. You'll discover that Ford savings begin the moment you buy . . . for Fords are traditionally priced lower. And yet Ford gives you big-car size plus features once found only in luxury-priced cars.

You'll be thankful you chose a 1960 Ford every time you pull up to a gasoline pump. All Ford standard engines, Six or Thunderbird V-8, thrive on regular fuel. You get premium performance without paying a premium price; save up to \$1.00 on every tankful. But that's not all. Ford's new 2-stage Full-Flow oil filter (standard equipment) lets you go 4000 miles between oil changes, too. You save and save!

Put an end to the nuisance and expense of frequent muffler replacement. The aluminized mufflers on 1960 Fords normally last about twice as long as ordinary mufflers used on other cars. Other Ford savings include a 66-plate battery (instead of the usual 54) in an exclusive mounting designed to prevent corrosion. And Ford's Diamond Lustre Finish stays beautiful without waxing ever!

Take your pick of great Thunderbird V-8 engines! Or choose the thrifty Mileage Maker Six. The V-8's range from the Thunderbird 292 V-8 right on up to the Thunderbird 352 Special V-8 with 4 barrel carburetion—two for normal driving plus two in reserve for breath-taking GO! Select the transmission that's best for your driving: Fordomatic, Cruise-O-Matic, Overdrive or 3-Speed.



here's why **the 60 FORDS** mean more SAFETY

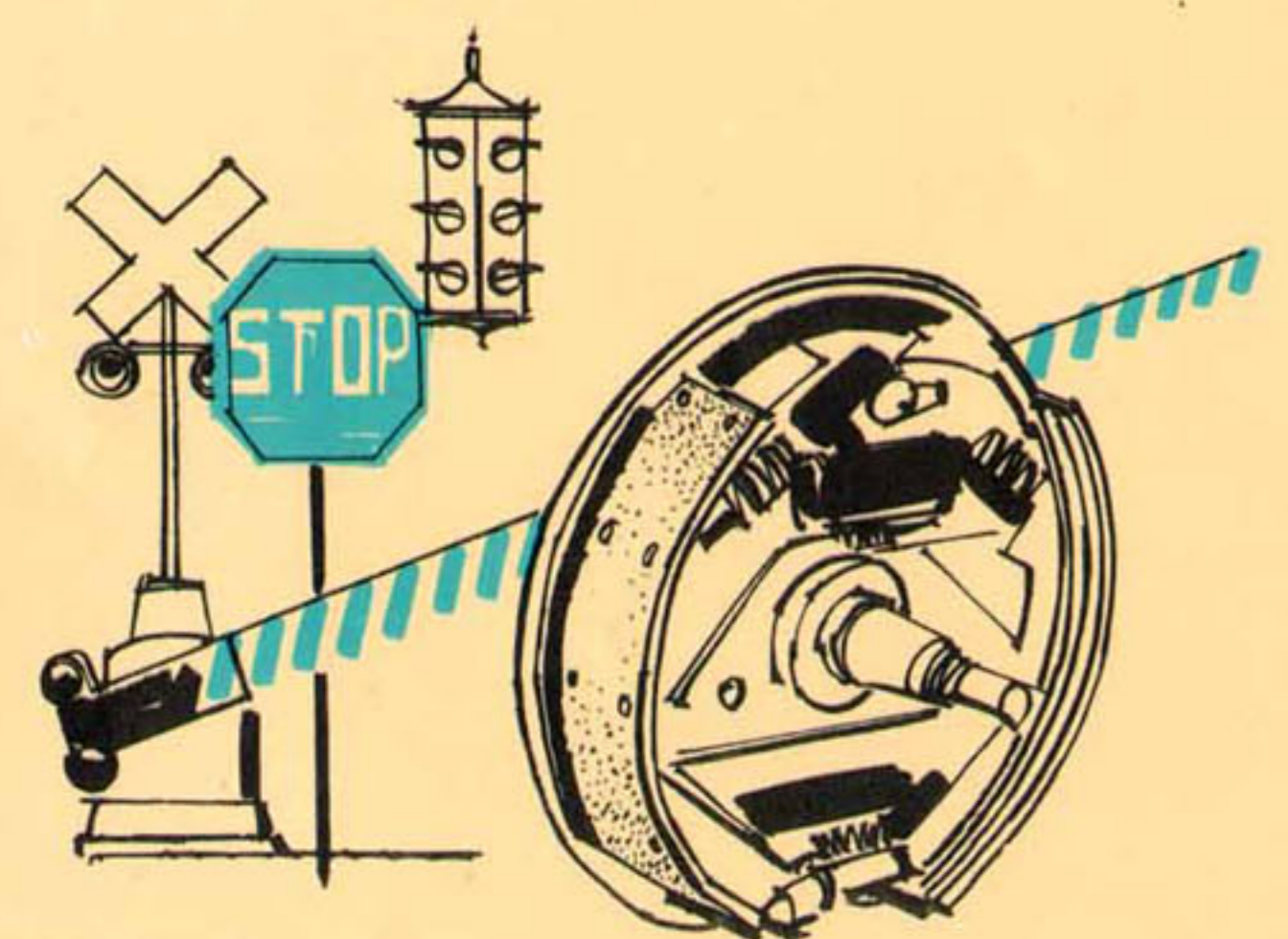

**Truck Size Brakes are 25% larger; biggest in Ford's field**

You get stopping power to match your GO power in a 1960 Ford. Brakes are Truck Size with 25% more brake lining than before! They are the biggest brakes in the low-price field; operate with very little pedal pressure. Brake drums are wider, heavier, with cooling grooves to dissipate heat faster. Front brakes have better air circulation. As a result, these new Ford brakes have greater resistance to "fade out" on emergency stops . . . last far longer.

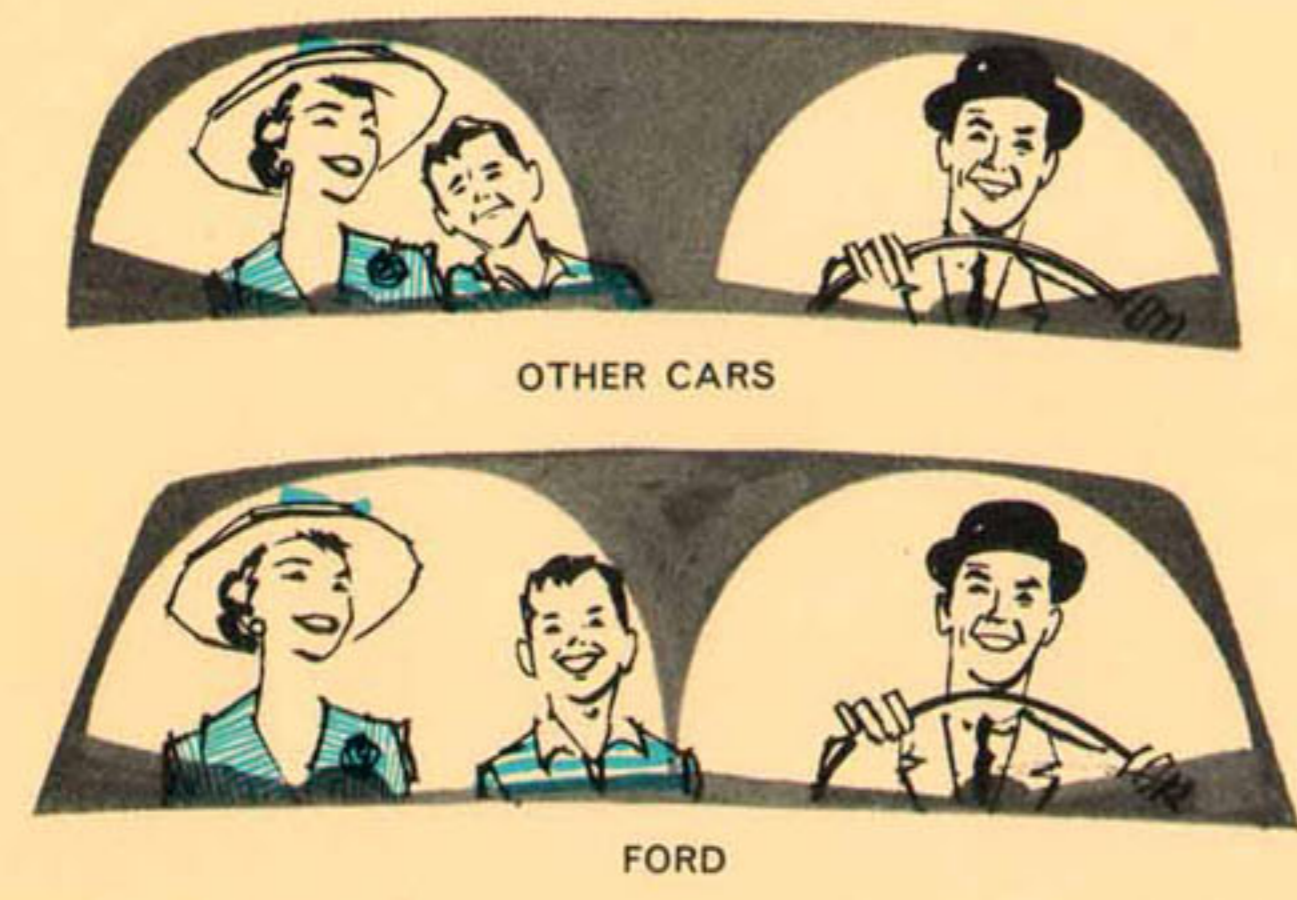

**Better visibility with improved wiper pattern; more safety glass**

Up to 31% more safety glass area plus Ford's new lower-angle hood-and-fender design combine to give you the best visibility ever in the 1960 Fords. For example, these features let you enjoy 55% greater sky-to-road visibility through the new compound windshield! And yet it's so designed as to shield you from heat and glare. Wiper blade length has been increased to 15 inches, too, so that the middle passenger now has excellent visibility from the front seat.

**Safety-Girder provides all-around protection for all passengers**

Safety is built in when you drive a 1960 Ford. It has a Wide-Contoured, safety-type frame—now 25% stronger—that surrounds the passenger compartment with a rugged ring of steel. It is safer by far than the X-type frames used on some other cars in Ford's field. In a Ford all six passengers ride within the massive side rails for extra protection in case of side impact. Insist on this added Ford protection.

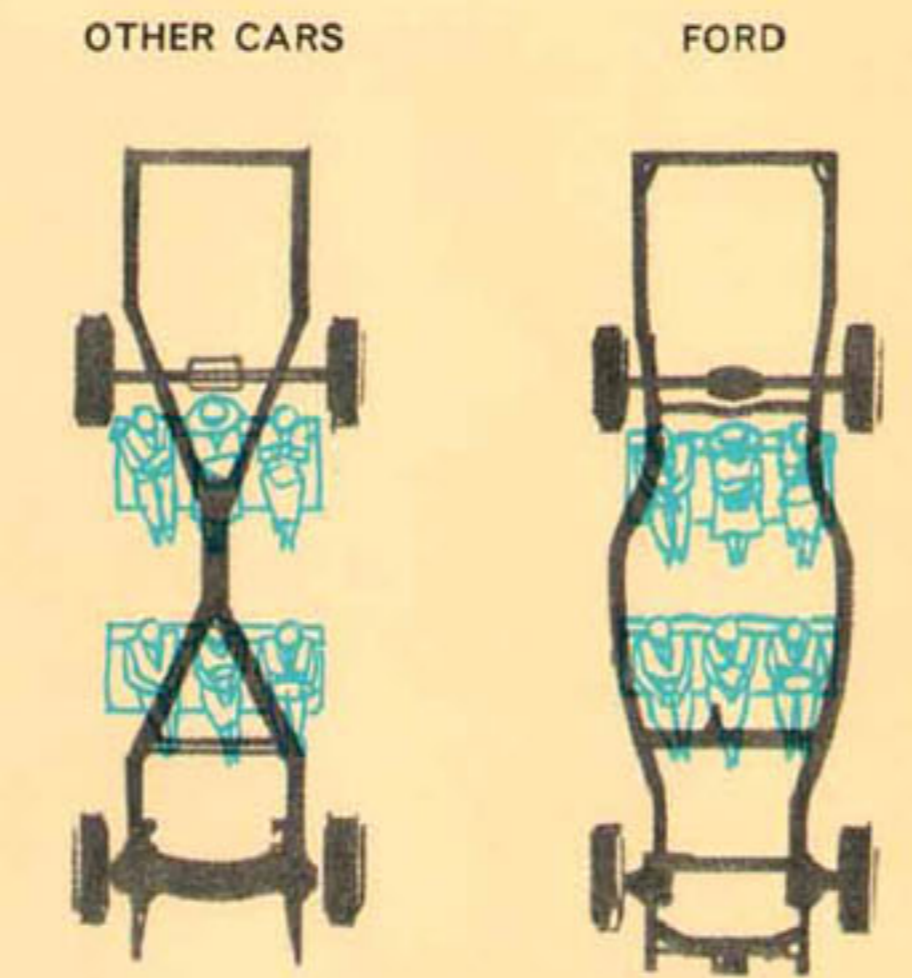

Set your family **2** Ford free in **1960**



**Falcon**

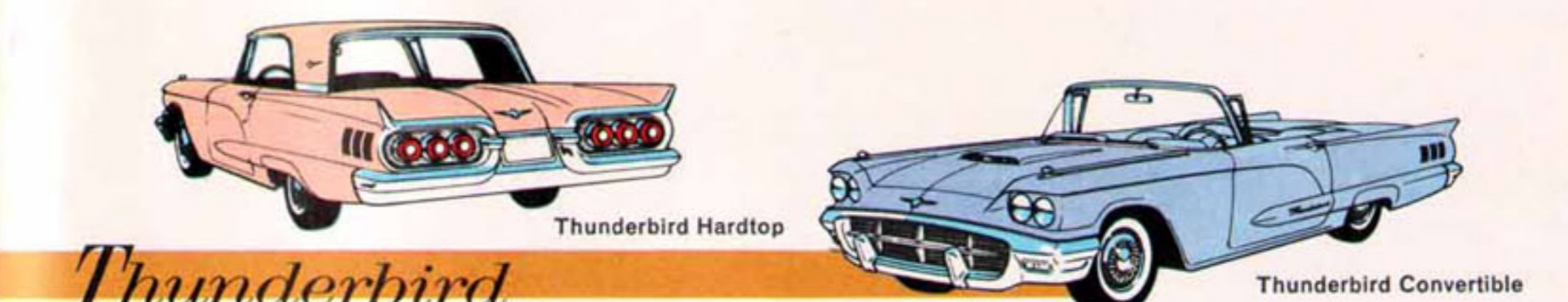

**Thunderbird**

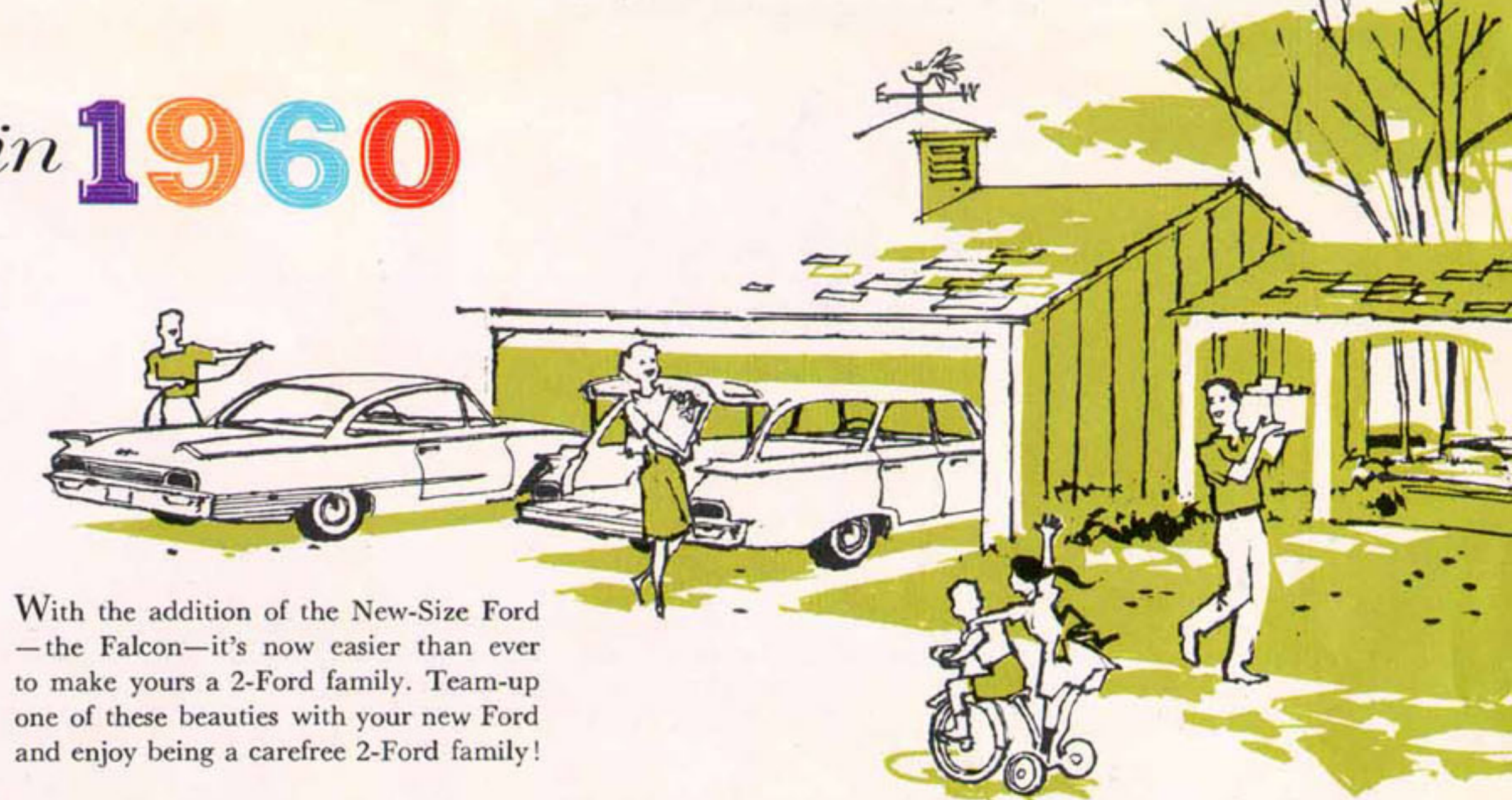

With the addition of the New-Size Ford—the Falcon—it's now easier than ever to make yours a 2-Ford family. Team-up one of these beauties with your new Ford and enjoy being a carefree 2-Ford family!

**FORD BUILDS THE WORLD'S MOST BEAUTIFULLY PROPORTIONED CARS**

FORD—The Finest Fords of a Lifetime FALCON—The New-Size Ford THUNDERBIRD—The World's Most Wanted Car

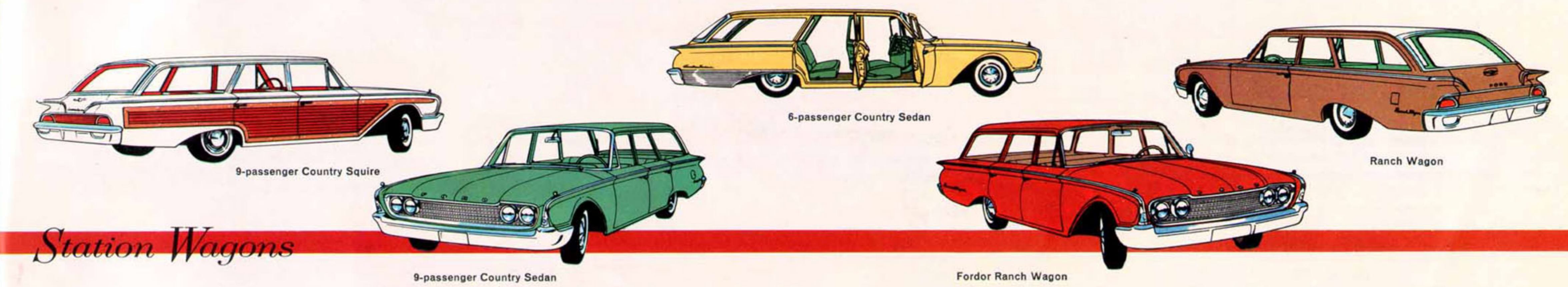

**Station Wagons**





The new Ford Quality Audit system, a Ford first, results in products of highest quality. Quality Audit teams select samples from each shift at every assembly plant for an exhaustive search for any deviations from strict quality standards. This enables assembly operations to check and adhere to this quality control at all times.

# SPECIFICATIONS



GROUND

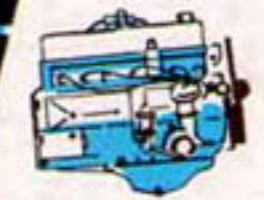
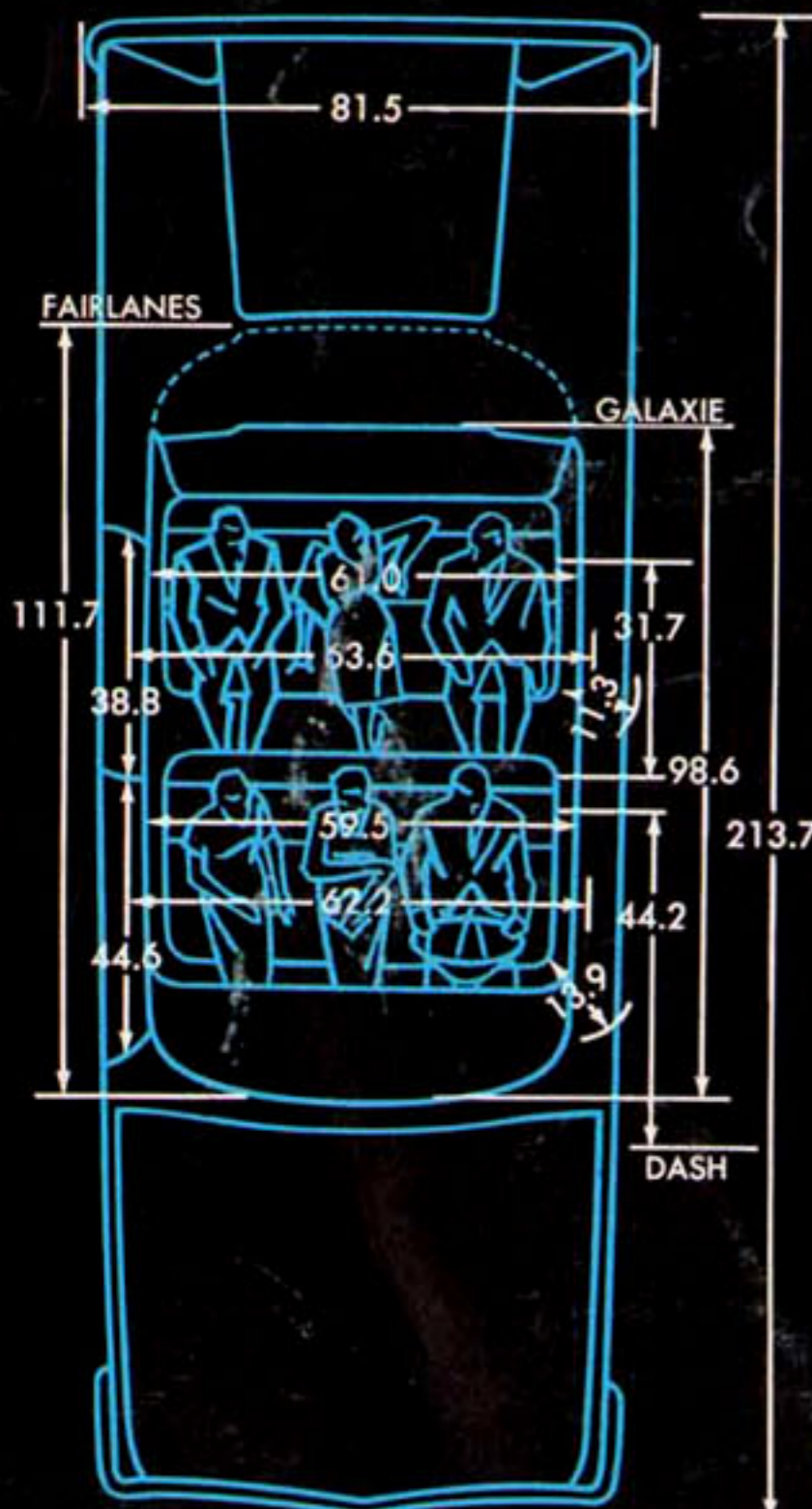

**Engines: 145-hp Mileage Maker Six**—223-cu. in. displ.; 3.62" bore x 3.60" stroke; 8.4 to 1 comp. ratio; regular fuel; low-silhouette unit-design carburetor; manual choke; full-vacuum spark control; precision-molded crankshaft with four main bearings; new high-capacity rotor-type oil pump; oil capacity, with filter change, 5 qt.

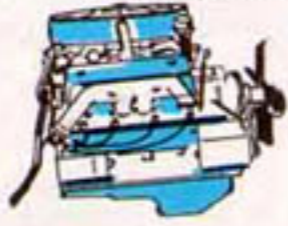

**185-hp Thunderbird 292 V-8** (standard V-8 on all models)—292-cu. in. displ.; 3.75" bore x 3.30" stroke; 8.8 to 1 comp. ratio; regular fuel; low-silhouette 2-venturi carburetor, new automatic choke; higher efficiency centrifugal-vacuum spark control; new wedge-type combustion chambers and smaller intake valves for better fuel economy; precision-molded crankshaft, copper-lead main (five) and con. rod bearings; rotor oil pump; oil capacity, with filter change, 6 qt.; Y-type single exhaust (dual on Sunliner).

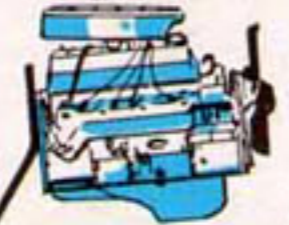

**235-hp Thunderbird 352 V-8** (optional on all models)—352-cu. in. displ.; 4.00" bore x 3.50" stroke; 8.9 to 1 comp. ratio; regular fuel; low-silhouette 2-venturi carburetor, new automatic choke; higher-efficiency centrifugal-vacuum spark control; aluminized valves with hydraulic lifters and alternate intake-exhaust valve placement for longest life; precision-molded crankshaft with large journal overlap, copper-lead main (five) and con. rod bearings; rotor oil pump; oil capacity, with filter change, 6 qt.; Y-type single exhaust (dual on Sunliner).

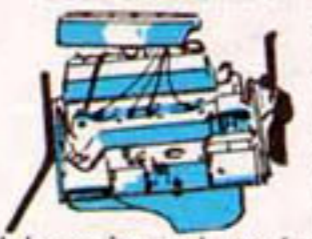

**300-hp Thunderbird 352 Special V-8** (optional on all models)—352-cu. in. displ.; 4.00" bore x 3.50" stroke; 9.6 to 1 comp. ratio; premium fuel; low-silhouette 4-venturi carburetor, new automatic choke; higher-efficiency centrifugal-vacuum spark control; aluminized valves with hydraulic lifters and alternate intake-exhaust valve placement for longest life; precision-molded crankshaft with large journal overlap, copper-lead main (five) and con. rod bearings; rotor oil pump; oil capacity, with filter change, 6 qts.; dual exhausts.

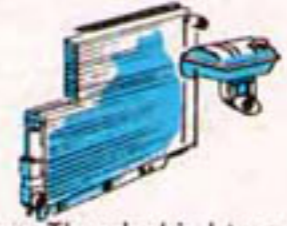

**Engine Features:** For greater economy and longer life, all Ford engines have Short Stroke, low-friction design; Deep-Block construction; Free-Turning overhead intake and exhaust valves; new Super-Filter air cleaner with reusable element; new high-capacity in-line fuel filtering system with combination fuel and vacuum-booster pump for more constant windshield-wiper action; new Rotunda 2-phase Full-Flow disposable-type oil filter; new Thunderbird-type Cross-Flow cooling system with separate top reserve tank and 180° Positive-Action thermostat; 12-volt electrical system; weatherproof ignition with new Static-Ban constant resistance wiring and air-cooled distributor points; triple-seal 18-mm. Turbo-Action spark plugs; 66-plate, 55 amp-hr battery (78-plate, 65 amp-hr with Special V-8 and automatic transmission); new full-wrap-rubber rear engine mount; new aluminized muffler with integral tailpipe mounted at rear of frame. All V-8's electronically balanced while operating under their own power for extra smoothness.



**Clutch and Manual Transmissions:** Semi-centrifugal clutch with full-weighted levers for more positive engagement; suspended pedal. Face diameter—9 1/2" with Six, 10 1/2" with 292 V-8, 11" with 352 V-8's. **3-Speed** has shot-peened fine-pitch-helical gears for high strength and quietness; forged bronze synchronizers. Tailored-to-engine ratios (to 1): **Six**—1st 3.09, 2nd 1.92, direct 1.00, rev. 3.67; **292 V-8**—1st 2.78, 2nd 1.61, direct 1.00, rev. 3.38; **352 V-8's**—1st 2.37, 2nd 1.51, direct 1.00, rev. 2.81.



**Overdrive** (optional) is above 3-speed plus an automatic 4th gear that cuts in above 27 mph, cuts out below 21 mph (approx.). Downshift to direct by flooring accelerator. Lock-out control on instrument panel. Tailored-to-engine ratios (to 1): **Six**—1st 2.80, 2nd 1.69, direct 1.00, OD .70, rev. 3.80; **292 V-8**—1st 2.37, 2nd 1.43, direct 1.00, OD .70, rev. 3.21; **352 V-8's**—1st 2.49, 2nd 1.59, direct 1.00, OD .72, rev. 3.154.



**Automatic Transmissions** (optional): Torque converter in combination with compound planetary gear set. Effective engine braking in "L" position. Water cooled. Selector lever on steering column, illuminated quadrant. **Fordomatic**

**Drive** features simplified design with one clutch assembly, lightweight cast-aluminum construction, minimum servicing (each 24,000 miles). Two forward gear ratios, one reverse (to 1): low 1.75, direct 1.00, rev. 1.50; converter (stall) 2.6 with Six and 292 V-8, 2.5 with both 352 V-8's. In "D" range gives brisk, smooth starts in low. New, durable cellulose clutch plates for satin-smooth upshift. Selector sequence P-R-N-D-L.



**Cruise-O-Matic Drive** for V-8's features two selective drive ranges: "D1" starting in low for all normal driving, "D2" starting in intermediate for more sure-footed driving on slippery surfaces. Three forward gear ratios, one reverse (to 1): low 2.40, intermediate 1.47, direct 1.00, rev. 2.00; converter (stall) 2.1. New 12" converter, increased stall speed and moderately higher axle ratio results in even greater responsiveness without compromising fuel economy. Selector sequence P-R-N-D2-D1-L.



**Rear Axle:** Semi-floating type with deep-offset hypoid gears. Straddle-mounted drive pinion. **Torque-Tailored Axle Ratios (to 1): Conventional Drive**—3.56 with all engines. **Overdrive**—3.89 with Six or 292 V-8, 3.56 with both 352 V-8's. **Fordomatic Drive**—3.56 with Six, 3.10 with 292 V-8, 2.91 with both 352 V-8's. **Cruise-O-Matic Drive**—3.10 with 292 V-8, 2.91 with both 352 V-8's. Optional Equo-Lock Differential Ratios (to 1): Same as standard above, except 3.10 with both 352 V-8's and automatic transmissions.

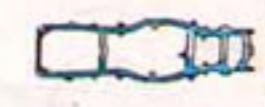

**Wide-Contoured Frame:** Longer, wider box-section design with deeper side rails having 25% higher strength and rigidity. Sunliner has 4 cross members plus X-member, others have 5 cross members. Side rails extend outside passenger area, for better foot room and increased side protection. Silent-Grip body mounts.



**Front Suspension:** Swept-Back, Angle-Poised Ball-Joint type with longer coil springs and larger rubber bushings in lower arms for softer ride. Threaded, permanently lubricated bushings in upper arms. Front end has link-type, rubber-bushed ride stabilizer to control roll on turns. Internally mounted hydraulic double-acting shock absorbers.



**Rear Suspension:** All-new, asymmetrical, variable-rate design with rear axle located well forward from center of springs for anti-dive and anti-squat control on braking and acceleration. Extra-long, gentle-rate, leaf-type springs with wide spring base provide a softer, more stable, leveled ride. Outboard mounted. Tension-type shackles. Axle nose bumper. Diagonally mounted hydraulic double-acting shock absorbers.



**Steering:** Magic-Circle low-friction recirculating-ball type steering gear provides easy handling. Protective rear mounting. Anti-friction bearings throughout. Symmetrical linkage. Over-all steering ratio 27 to 1, with power steering 25 to 1. Lifeguard 3-spoke, deep-center steering wheel. Turning diameter 40 1/2 ft.



**Brakes:** All-new Truck Size double-sealed, self-energizing hydraulic brakes have suspended pedal, dash-mounted master cylinder. Heavier, wider, grooved 11" diameter composite drums with wider molded linings result in longer life, cooler operation and greater fade resistance. Lining area is 225.6 sq. in. Foot-operated parking brake with new pull-out release on instrument panel. Optional Swift Sure power brakes have special low pedal and power reservoir tank.



**Tires:** 4-ply, black, tubeless with Tyrex cord. Safety-type rims. Sunliner—8.00 x 14 on 5 1/2" rims with all engines. Other models—7.50 x 14 on 5" rims with Six and 5 1/2" rims with 292 V-8; 8.00 x 14 on 5 1/2" rims with both 352 V-8's. White sidewall tires optional.

**Dimensions:** 119" wheelbase on all models; wide treads, 61.0" front, 60.0" rear. For other dimensions, see illustrations at left.

**Prices:** All Power Assists, Optional Equipment and Accessories as well as some of the items illustrated or referred to in this catalog are at extra cost. For the price of the model with the equipment you desire, see your Ford Dealer.

Comparative information in this catalog was obtained from authoritative sources, but is not guaranteed. The specifications contained herein were in effect at the time this catalog was approved for printing. Ford Division of Ford Motor Company reserves the right to discontinue models at any time, or change specifications or design without notice and without incurring obligation.

Compliments of

your friendly **FORD** dealer

FORD DIVISION, Ford Motor Company.