

1971 Plymouth Fury

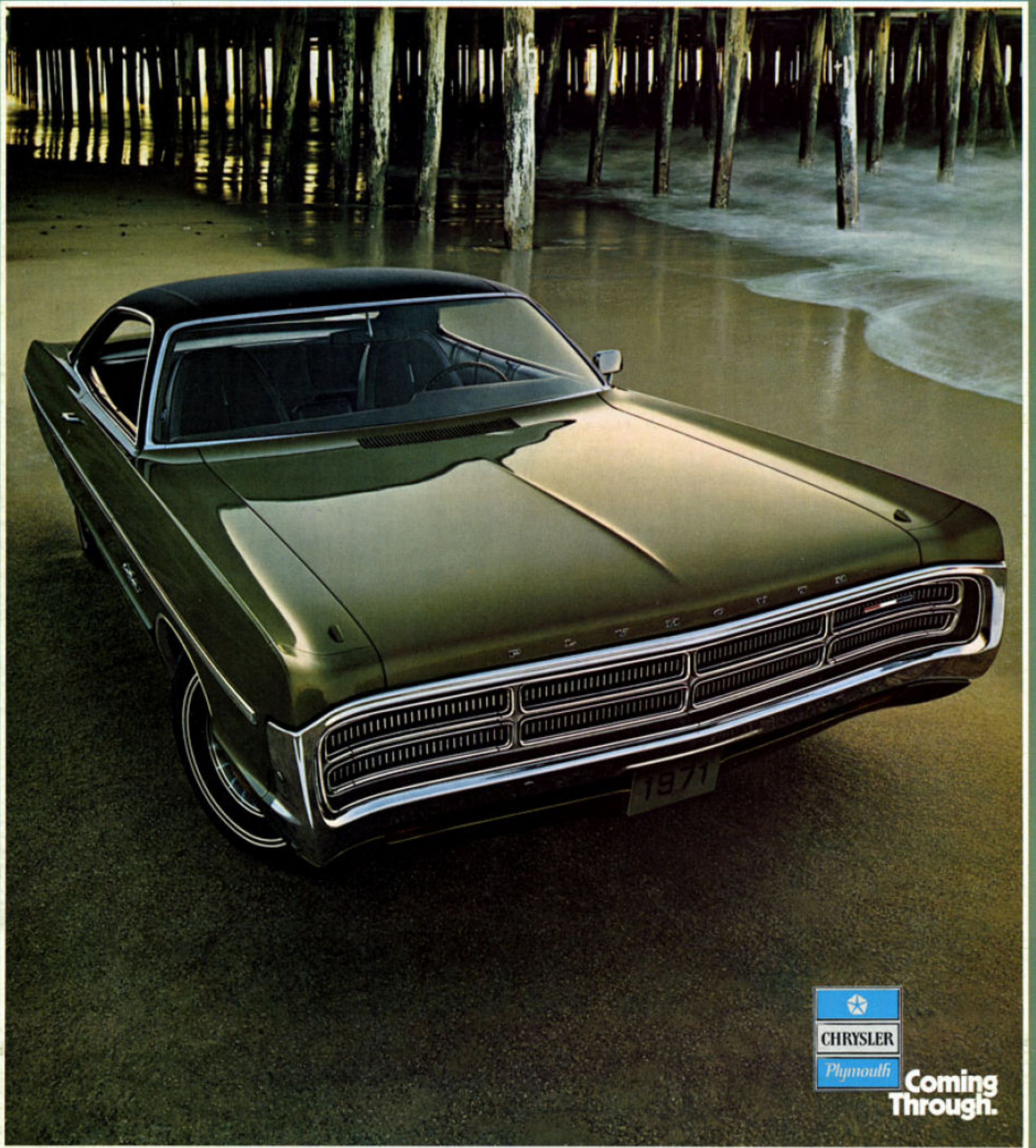

**Coming
Through.**



Fury comes through for you in 1971



Sport Fury, Sport Fury GT . . . Pages 4-11

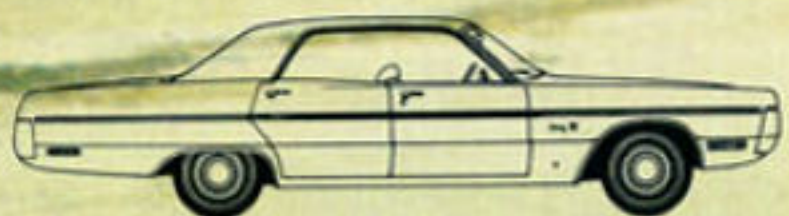

Fury III . . . Pages 12-17

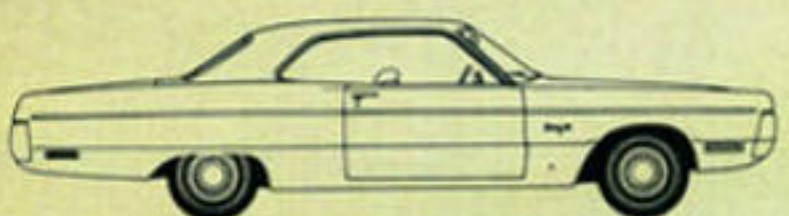

Fury II . . . Pages 18-19

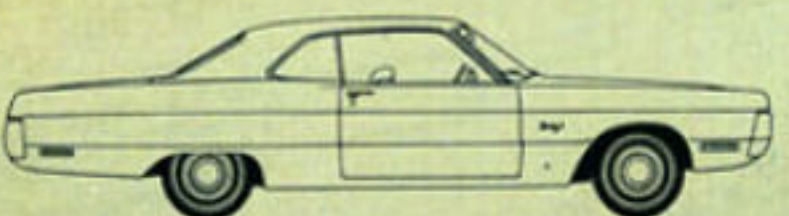

Fury I . . . Pages 18-19



Fury Wagons . . .

See 1971 Plymouth Wagon Catalog

Fold out back cover for:
Engines, Options, Colors

Coming through with new features. Striking new front-end treatment • New coordinated interior selections • Torsion-Quiet Ride • An optional 360 CID V-8 that runs on regular low-leaded gas • The smooth lines of ventless side glass • Optional upper level ventilation • New optional rear bumper and taillamps • Colorful new colors • And more.

This year we're coming through with the finest cars we've ever built. A total of 25 big, roomy, good-looking new Fury sedans, wagons, and hardtops . . . all with new Torsion-Quiet Ride.

Many with more hip, shoulder, head and stretch-out room, front and rear, than the highest-priced luxury models. And starting at prices thousands of dollars less.

We're coming through with new developments in cleaner air devices for our engines. With more engines than ever before that run on regular gas.

Every car we build must pass the most rigid quality control. The result is a car totally designed, totally engineered, and completely built with one thing in mind. To come through with the finest handling, riding and performing Plymouth Fury ever.

A luxurious new comfort and handling package. We call this new package Torsion-Quiet Ride. As the diagram points out it starts with a completely welded Unibody (a) that

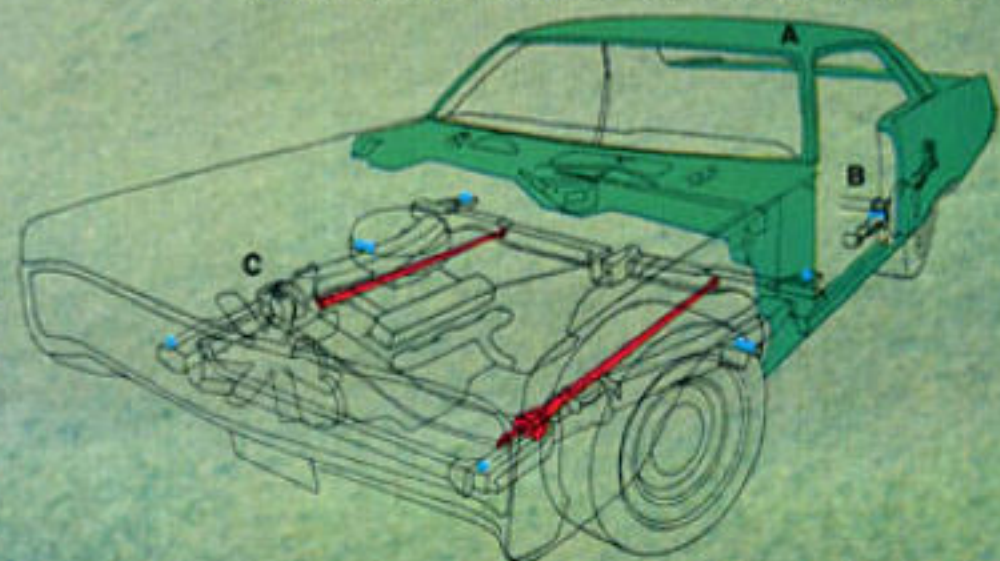

has no bolts to work free and rattle. In addition, ten rubber sound isolators (b) separate the frame and the front and rear suspension from the body of the car. Handling is also an important part of Torsion-Quiet Ride. Our torsion bars and front sway bars (c) twist and flex road shock and mushiness out of the ride. Finally, we add over 125 square feet of sound insulation material to shelter you from the hub-bub going on outside. The result is a quiet, controlled, relaxing ride.

New standard features that we're proud of. Standard on all Sport Furies—a Urethane rear bumper-appliqué that protects against dents and scratches and won't rust. It's color keyed to the protective vinyl side moldings (which protect your car from door nicks), and is a tasteful complement to our elegant Boar Grain Vinyl Roof. In handsome black, white, blue, green and gold. Then there's new keyless door locking. Streamlined ventless side glass. Hidden windshield wipers. Long wearing bias-belted tires.

An anti-theft ignition system that locks the steering column and transmission linkage when you remove the key. And warns you to take the key when you leave the car. Interiors are plushier than ever. With rich simulated wood-grain accents. Supple vinyls. Rich Bedford cord weaves. Bench seats with soft pull-down center armrests and integrally styled head restraints.

Coming through with new options. New: Optional Stereo Tape Cassette System with the ability to record off the radio plus a microphone for dictation. A Chrysler Corporation exclusive.

New: Optional Strato-Vent fresh

air system. Keeps the air circulating without bringing in any outside noise. Our system operates with a 3-speed blower for maximum effectiveness.

New: Another fresh air feature. It's an optional electrically-operated sun roof on 2-door hardtops. You get most of the advantages of a convertible with hardtop safety and styling.

New: An optional 360 cubic inch V-8. Like most of our other engines, it runs on regular gas. Also available . . . a thrifty 225 cubic inch Six . . . a thoroughly proven 318 and two 383 V-8s . . . and two 4-barrel 440s. Seven big engines in all.

New: An optional system that washes headlamps and scrubs them clean with nylon brushes. (Sport Fury only.) Another Chrysler Corporation exclusive for better illumination and your safety.

What coming through is all about. It's all about you. Your comfort. Your style. Your demand for excellence. That's how Plymouth Fury comes through for you.

Fury I, II, and III Standard Features

Torsion-Quiet Sound Isolation System • Choice of 225 Six or 318 V-8 Engines • Loop Front Bumpers • Dual Headlamps • Bias-Belted Tires (Set of 5) • Hub Caps (Set of 4) • Padded Instrument Panel • Brake Warning Light • Outside Rearview Mirror, Driver's Side • Fuel Gauge • Temperature Gauge • Ammeter • Low Oil Pressure Warning Light • Thumbwheel Panel Light Dimmer and Interior Lights • Inside Day/Night Rearview Mirror • Keyless Door Locking • Dual Braking System w/Self-adjusting Brakes • Armrests, Front and Rear • Instrumentation with Non-glare Floodlights • Dual Front Shoulder Harness • 2-Speed Electric Windshield Wipers •

Push-Button Electric Windshield Washers • Directional Signals w/Lane-Change Features • Cigar Lighter • Glove Box Lock • 3-Spoke Steering Wheel with Integral Horn Button • Dome Light • Front Door Courtesy Light Switches • Padded Sun Visors • Roof Silencer and Insulation • Safety Door Locks • Emergency Flashers • Back-up Lights • Coat Hooks • Ashtrays in Instrument Panel and Rear Armrests • Dual Horns • Bright Drip Rail Molding • Concealed Windshield Wipers • Rear Compartment Sound Barriers • Side Marker Lights and Reflectors • All-Aluminum Grille • Fresh-Air Heater and Defroster • Side Cowl Fresh-Air Ventilation • Many Other Safety and Convenience Features

Deep-Pile Carpeting with Padding* • Bright Full-Length Body Side Molding** • Full-Length Body Side Moldings with Color-Keyed Protective Vinyl Inserts† • Ashtray Light† • Trunk Compartment Light† • Bright Upper Door Frame Molding (4-Door)† • Bright Wheel Lip Molding† • Simulated Wood-Grain Inserts on Door Trim Panels† • Simulated Wood-Grain Accent on Instrument Panel Cluster and Pad† • Glove Box Light† • 3-Spoke Steering Wheel with Simulated Wood-Grain Insert† • Dual-Sized Taillamps with Bright Ornamentation† • Bright Base Armrests, Front and Rear†

*Not on Fury I

**Fury II only

†Not on Fury I or II

Sport Fury Standard Features

(All of the Above Plus the Following)

318 V-8 • Door Pull Strap • Lower Door Panels, Carpeted • Pull-down Center Armrest Seat with Integral Head Restraints • Die-Cast, Chrome-Plated Grille • Sill Molding • Belt Molding (Except Sedan) • Concealed Dual Headlamps • Red, White and Blue Radiator Grille Ornament • Sport Fury Nameplates w/Red, White, and Blue Medallions • Body Side Molding with Color-Keyed Dual Vinyl Inserts • Color-Keyed Urethane Rear Bumper Pad • Extra Rear-Seat Sound Barrier • Dome Lamp Rear-Door Courtesy Switches (4-Dr. Sedan Only)

Sport Fury GT Standard Features

(All of the Above Plus the Following)

440 4-barrel Super Commando Engine • Automatic Transmission • Hood Stripes • Strobe Tape Stripe (Side and Rear)†† • H70 x 15 Bias-Belted Tires with White Lettering (Set of 5) • Rallye Road Wheels (Set of 4) • Heavy-Duty Suspension • Power Disc Brakes • 3.23 Axle Ratio • Heavy-Duty 70 Amp/Hr. Battery • Dual Exhausts

††Body Side Molding deleted

Standard Safety Features (All Furies)

Large rear reflectors and lights • Fuel tank impact protection • Lane-change turn signal • Locking steering column • Superior seat belt anchorage • Energy-absorbing steering column • Energy-absorbing front seat-back and armrests • Energy-absorbing instrument panel padding • Seat belts, all seating positions • Shoulder belts, 2 front • Manual door locks—levers have non-override lock feature, except driver's door • Interlocking door latches • Inside door release levers, flush-type • Padded sun visors • Dual braking system with warning light • Side marker lights • Hazard warning light system • Windshield wipers, 2-speed, electric • Windshield washers, electric • Head restraints, 2 front • Locking latch on all folding front seat-backs • Left outside rearview mirror • Vinyl-clad day/night inside rearview mirror

Dimensions

Exterior 4-Door V-8 (Sedan)

Wheelbase	120 in.
Overall Length	215.1 in.
Overall Height	55.0 in.
Track—Front	62.1 in.
Track—Rear	62.0 in.

Interior 4-Door V-8 (Sedan)

Head Room—Front	38.8 in.
Head Room—Rear	38.4 in.
Leg Room—Front	41.8 in.
Leg Room—Rear	38.0 in.
Shoulder Room—Front	63.2 in.
Shoulder Room—Rear	62.7 in.

Useable Trunk Capacity 19.7 cu. ft.

Sport Fury

Sport Fury. Your invitation to gracious living. Twin-styled color-coordinated vinyl body side rub strips protect the beautiful baked enamel finish. Dual headlamps hide behind a rich, die-cast grille by day, shine by night. And Torsion-Quiet Ride with extra noise insulation material and solid, geared-to-the-road stability that reflects engineering excellence. Coming through with five sumptuously appointed models.



Sport Fury 2-Door Hardtop



Sport Fury 4-Door Sedan



Sport Fury 4-Door Hardtop

Sport Fury

Coming through with luxury's not enough. We also come through with the luxury of choice. Every Sport Fury gets a scratch- and dent-resisting Urethane rear bumper pad, standard. Color-key it to the vinyl body side moldings. And to an optional Boar Grain vinyl top. Choice of five handsome vinyl top colors.



Sport Fury 2-Door Formal Hardtop

Sport Fury GT

Sport Fury GT & Sport Fury

Two more ways we're coming through. (1) Our Sport Fury GT. Spot it by its dual hood stripes and side strobe stripes. A 440 4-barrel V-8 comes standard. An executive's supercar. (2) Our 2-door formal hardtop. Spot it by its custom roof line and look of restrained elegance. A super luxury car.

Sport Fury Interiors

We're coming through with luxury inside as well as out. Touches of simulated American Walnut wood-grain highlight the floodlit, padded instrument panel and accent the padded doors. Even carpeting

on the doors. **A.** Optional (at no extra cost) Sport Fury cloth-and-vinyl bench (all-vinyl standard). With integrally styled head restraints and fold-down center armrest. Available in blue, green, gold, tan,

black charcoal. **B.** Optional Sport Fury all-vinyl buckets. In blue, green, white, black. With integral head restraints. Select a center cushion w folding armrest or the optional floor-mounted console—at

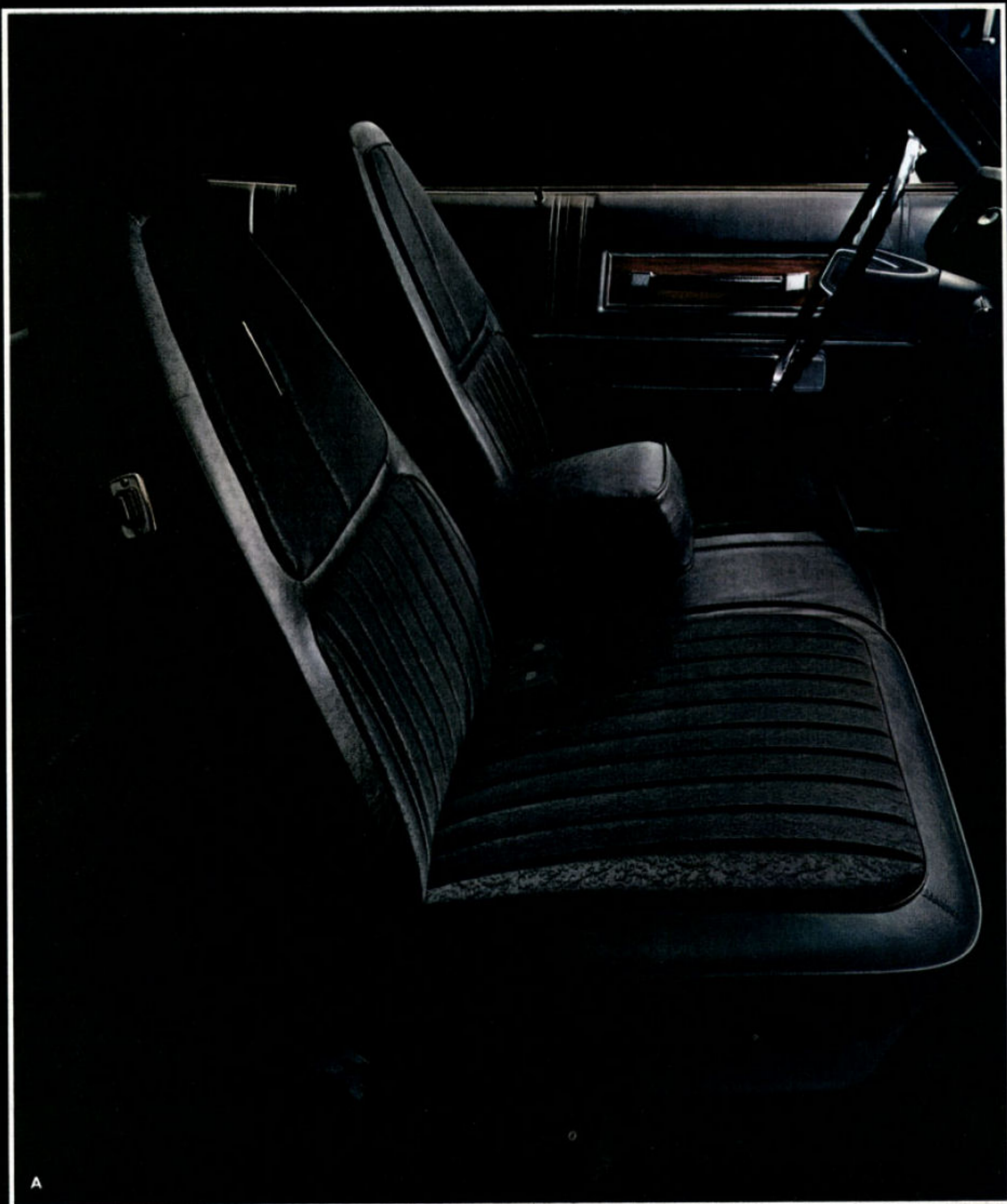

A

no extra charge. **C.** Brougham 4-door cloth-and-vinyl split bench. **A** five-foot-wide sofa that converts to individual adjustable armchairs — each with its own center armrest. The passenger side re-

clines. Available in green, blue, gold, black/charcoal. **D.** Optional Brougham Package. Seats elegantly styled in Bedford cord fabrics. With classic Brougham script on rear roof pillars. Brougham me-

dallion on padded dash. **E.** Brougham 2-door comfort seats. Covered in cloth-and-vinyl. Individual seat adjustment, reclining passenger-side, center armrest. In green, black/charcoal, blue and gold.





Fury III 2-Door Hardtop



Fury III 4-Door Hardtop

Fury III

Coming through better than ever is our best-selling Fury series, Fury III. Six models deep. With new Torsion-Quiet Ride. A V-8 that runs on regular is standard. Or with the 2-door hardtop and sedan you can choose the economical 225 Six. All the size and comfort of more expensive cars at a lower price. Just some of the things that make it our best seller.



Fury III 2-Door Formal Hardtop



Fury III 4-Door Sedan

Fury III

Our Formal 2-door hardtop comes through for those who want a Fury III with luxurious appointments. Our beautiful new 4-door sedan comes through for families who want four-door convenience and comfort. Other comforting thoughts. Options like Airtemp air conditioning, power windows, steering and brakes. Ask your Plymouth salesman for full details on options.

Fury III Interiors

Deep, extra-thick padded seats. Simulated wood-grain inserts on doors, padded dash and floodlit instrumentation. Just a few of the ways Fury III comes through for

you. Options include 6-way power seat. Tilt Steering Wheel with Rim-Blow horn switch. Added comfort now. Added trade-in value later. **A.** Standard Fury III cloth-

and-vinyl bench. With applied head restraints. In blue, green, gold, black/charcoal. **B.** Fury III floodlit instrumentation. All gauges, switches and controls are fully



A

lighted. Real gauges; not just warning lights. **C.** Optional Fury III all-vinyl buckets. With smart, integral head restraint styling. In green, white, blue, black. **D.** Optional

Fury III all-vinyl bench. With fold-down center armrest. Integral head restraints. In blue, green, tan, white, russet, gold, black/charcoal. **E.** Optional all-vinyl Fury III

split bench. With individual armrests and seat adjustments. Passenger side reclines. In black/charcoal only. Available in 4-door hardtops and sedans.

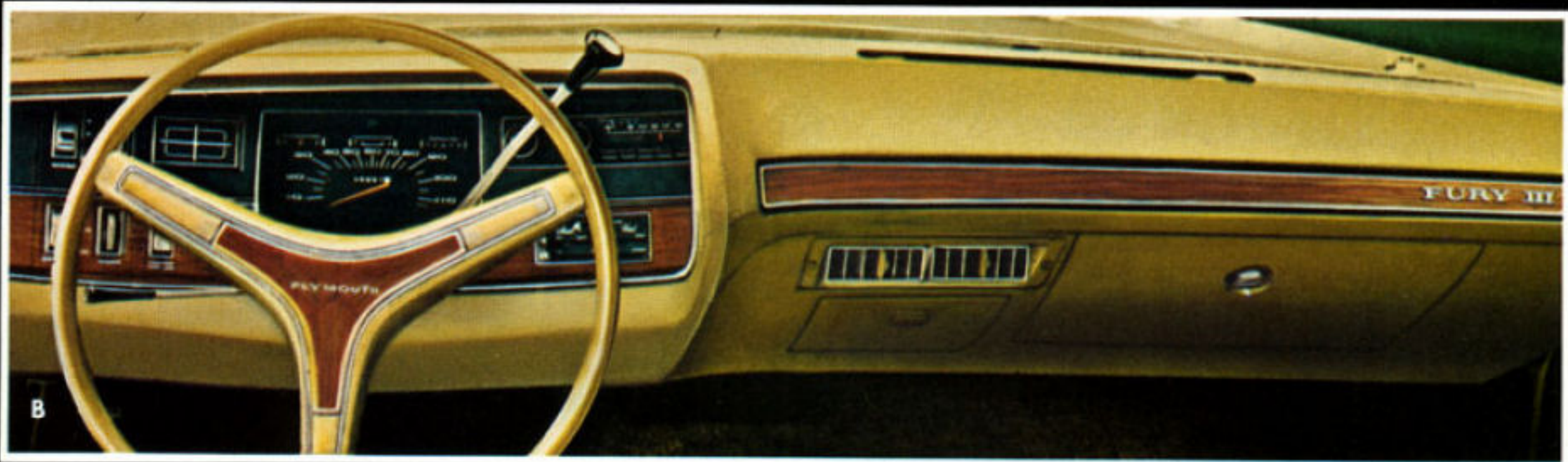

Fury II & I

Lowest priced ways we know of to get Fury size and comfort plus handsome styling. Fury II 2-door hardtop and Fury I coupe coming through. Our big Fury II (shown) and Fury I 4-door sedans have it all plus 4-door convenience. Add options until you reach the comfort and convenience level you want. Choose from over 50.



Optional Fury II all-vinyl bench with individually adjustable head restraints. In blue and black.

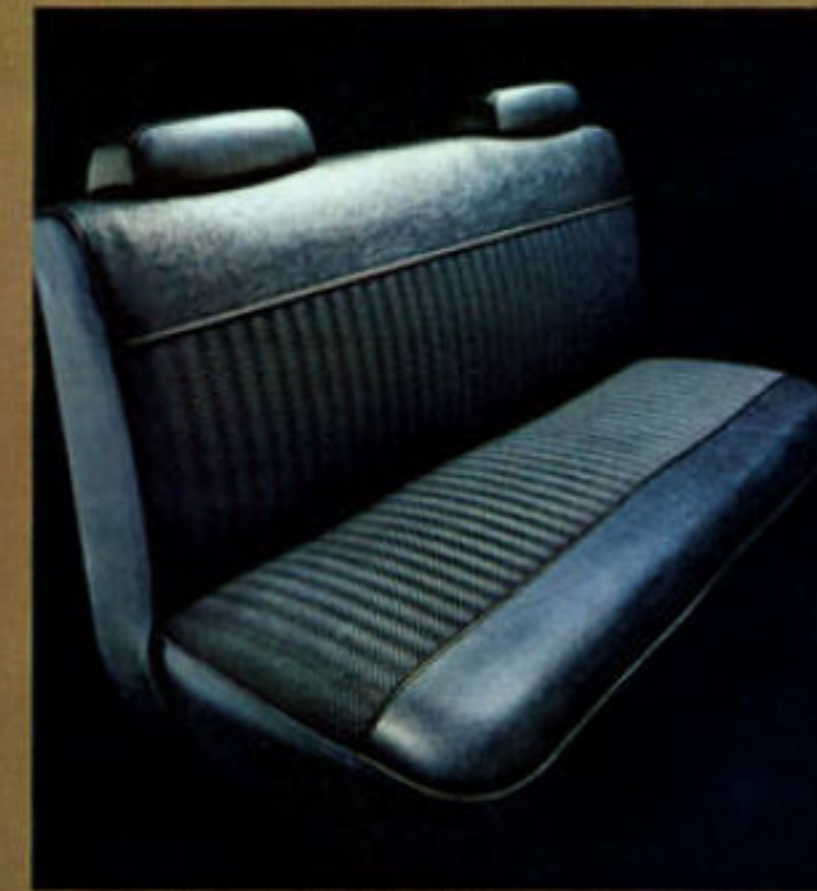

Standard Fury I all-vinyl bench with individually adjustable head restraints. In blue, tan, black/charcoal.



Standard Fury II cloth-and-vinyl bench, with individually adjustable head restraints. In blue, green and tan.



Fury II 4-Door Sedan



Fury I 2-Door Coupe



Fury II 2-Door Hardtop

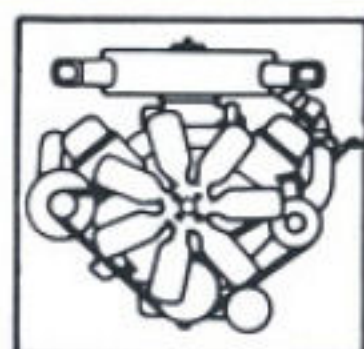
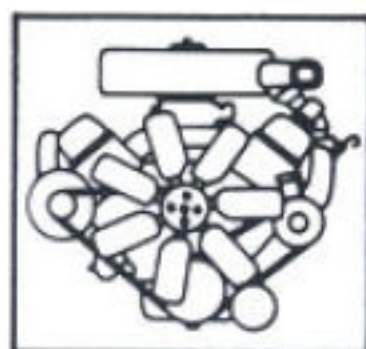
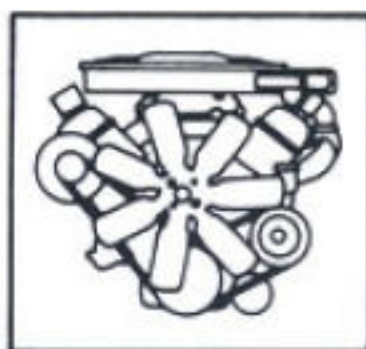
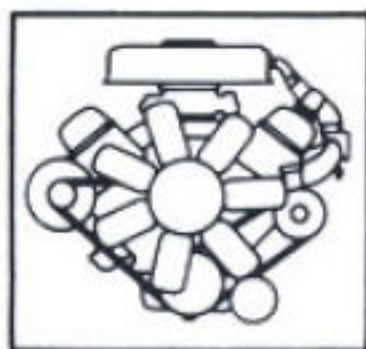
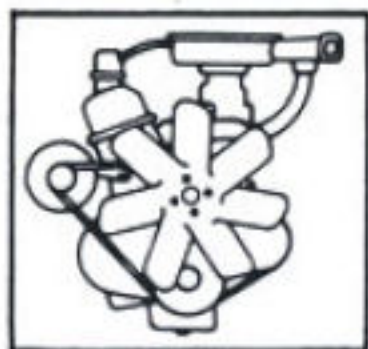

Displacement	Carb.	Horsepower Rating		Comp. Ratio	Air Cleaner	Exhaust System	Fury I, II, III	Sport Fury	Sport Fury GT
		Gross	Net*						
225 "6"	1-bbl.	145	110	8.4 to 1	Single Snorkel	Single	Std.	—	—
318 V-8	2-bbl.	230	155	8.6 to 1	Single Snorkel	Single	Std.	Std.	—
360 V-8	2-bbl.	255	175	8.7 to 1	Single Snorkel	Single	Opt.	Opt.	—
383 V-8	2-bbl.	275	190	8.5 to 1	Single Snorkel	Single	Opt.	Opt.	—
383 V-8	4-bbl.	300	250	8.5 to 1	Single Snorkel	Dual	Opt.	Opt.	—
440 V-8	4-bbl.	335	250	8.8 to 1	Dual Snorkel	Dual	Opt.	Opt.	—
440 V-8	4-bbl.	370	305	9.5 to 1	Dual Snorkel	Dual	—	—	Std.

*Installed

1971 Fury Options (Check your salesman for additional options and availability.)

Options	Fury I	Fury II	Fury III	Sport Fury	Sport Fury GT
Light Package	0	0	0	0	0
Basic Group	0	0	0	0	0
Trailer-Towing Pkg.	0	0	0	0	0
Brougham Package	NA	NA	NA	0	0
Heavy-Duty Brakes	0	0	0	0	NA
Power Disc Brakes—Front	0	0	0	0	S
Shoulder Belts—Rear	0	0	0	0	0
Console	NA	NA	0	0	0
Extra-thick Front Foam Seat Cushion	0	0	S	S	S
Accessory Floor Mats	0	0	0	0	0
Carpets	0	S	S	S	S
Sure-Grip Differential	0	0	0	0	0
50 Amp. Alternator	0	0	0	0	0
70 Amp. Battery	0	0	0	0	S
Tinted Glass—All Windows	0	0	0	0	0
Tinted Windshield Only	0	0	0	0	0
Manual Mirror—Right	0	0	0	0	0
Remote Control Mirror—Left	0	0	0	0	0
Rear Window Defogger	0	0	0	0	0
Strato Ventilation	0	0	0	0	0
Air Conditioning	0	0	0	0	0
Electric Clock	0	0	0	0	0
Headlamp Washer	NA	NA	NA	0	0
3-Speed Windshield Wipers	0	0	0	0	0
Pedal Dress-Up	0	0	0	0	0
Undercoating	0	0	0	0	0
Nightwatch Headlight Delay and Headlights-on Warning Signal	0	0	0	0	0
Door Edge Protectors	0	0	0	0	0
Bright Upper Door Frames (4/Dr. Sedan)	0	0	S	S	NA
Custom Sill Molding	0	0	NA	S	S
Belt Molding	0	0	0	S	S
Wheel House Opening Skirts	0	0	0	0	NA

Options	Fury I	Fury II	Fury III	Sport Fury	Sport Fury GT
Sun Roof With Vinyl Roof	NA	0	0	0	0
Bumper Guards—Front	0	0	0	0	0
Bumper Guards—Rear	0	0	0	NA	NA
Engine Block Heater	0	0	0	0	0
Automatic Speed Control	0	0	0	0	0
NOx Exhaust Emission Control	0	0	0	0	0
Power Bench Seat	0	0	0	0	0
Power Bucket or 50/50 Seat—Left	NA	NA	0	0	0
Power Windows	0	0	0	0	0
Power Door Locks	0	0	0	0	0
Power Deck Lid Release	0	0	0	0	0
Radio—AM	0	0	0	0	0
Radio—AM Deluxe	0	0	0	0	0
Radio—AM w/Stereo Tape (Cassette)	0	0	0	0	0
Rear Seat Speaker	0	0	0	0	0
Dual Rear Seat Speakers (Stereo)	0	0	0	0	0
Microphone	0	0	0	0	0
Radio—AM/FM Stereo	0	0	0	0	0
Radio—AM/FM Stereo w/Stereo Tape (Cassette)	0	0	0	0	0
Heavy-Duty Suspension	0	0	0	0	S
Heavy-Duty Shock Absorbers	0	0	0	0	0
Tilt Steering Wheel w/Rim-Blow	0	0	0	0	0
Power Steering	0	0	0	0	0
2-Spoke Rim-Blow Steering Wheel	0	0	0	0	0
Deluxe Wheel Covers	0	0	0	0	NA
Wire Wheel Covers	0	0	0	0	0
Rallye Road Wheels	0	0	0	0	S
Chrome Styled Road Wheels	0	0	0	0	0

0—Optional S—Standard NA—Not Available

COLORS: The key is to color-key. Check salesman to see how you can match optional vinyl roofs, and protective side moldings with vinyl inserts. Vinyl roofs are available in black, white, blue, green, and gold.

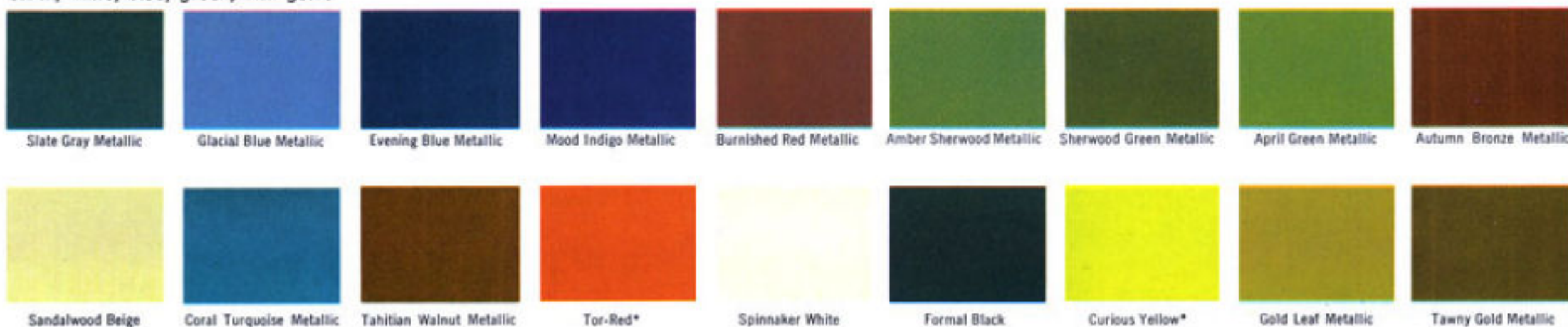

*Optional at extra cost 20

Options

1. & 2. **Light Package.** Includes courtesy lights. Fender-mounted turn signals. Instrument cluster lights that warn when fuel is low and reminds you to lock your doors. 3. **Deluxe Wheel Covers** (Set of 4). 4. **Rallye Road Wheels** (Set of 4). 5. **Chrome Styled Road Wheels** (Set of 4). 6. **Wire Wheel Covers** (Set of 4).

7. **Stereo Cassette Tape System.** With the ability to record off the radio plus a microphone for dictation. 8. **Sun Roof.** Electrically powered for smooth operation. On all 2-door hardtops except formal. 9. **Power Operated Headlamp Washer System.** Scrubs headlamps clean with nylon brushes. On all Sport Furies. 10.

Automatic Speed Control. Set and forget. Touch the brake pedal and it disengages. 11. **Fender Skirts.** A classic item. 12. **Strato-Vent Fresh Air System.** Switch on outside fresh air and turn off outside noise. 13. **Tilt Steering Wheel.** Easier entrances and exits. Adjusts to each driver's needs. Includes "Rim-Blow" horn.

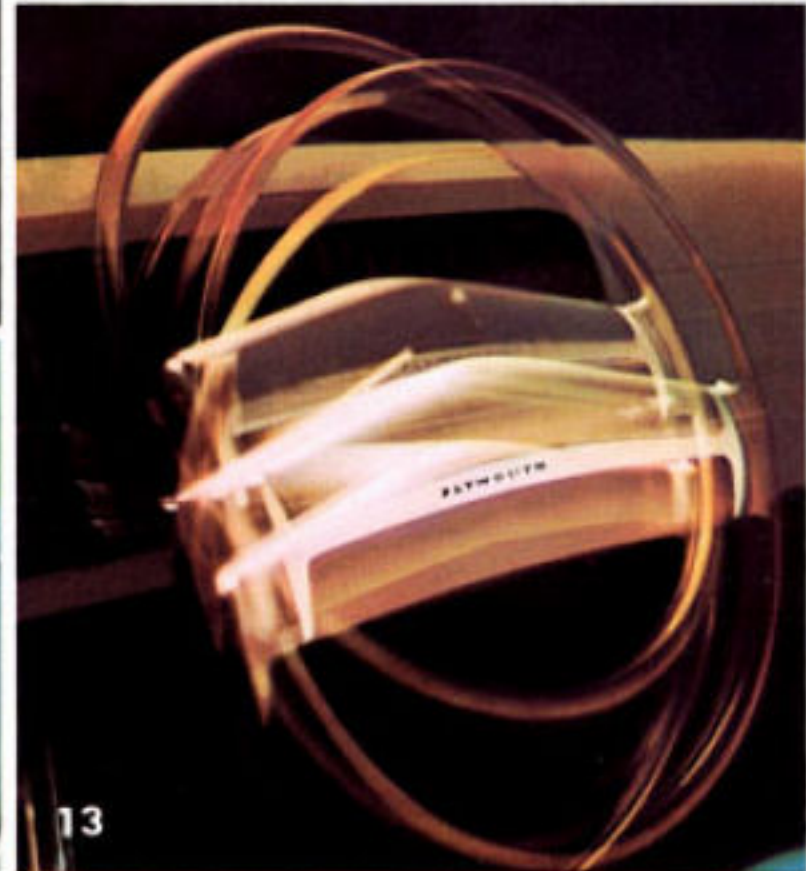
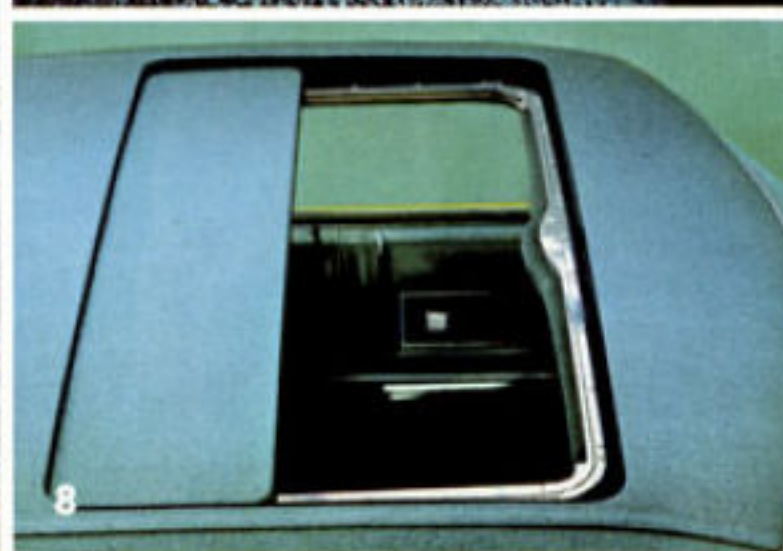
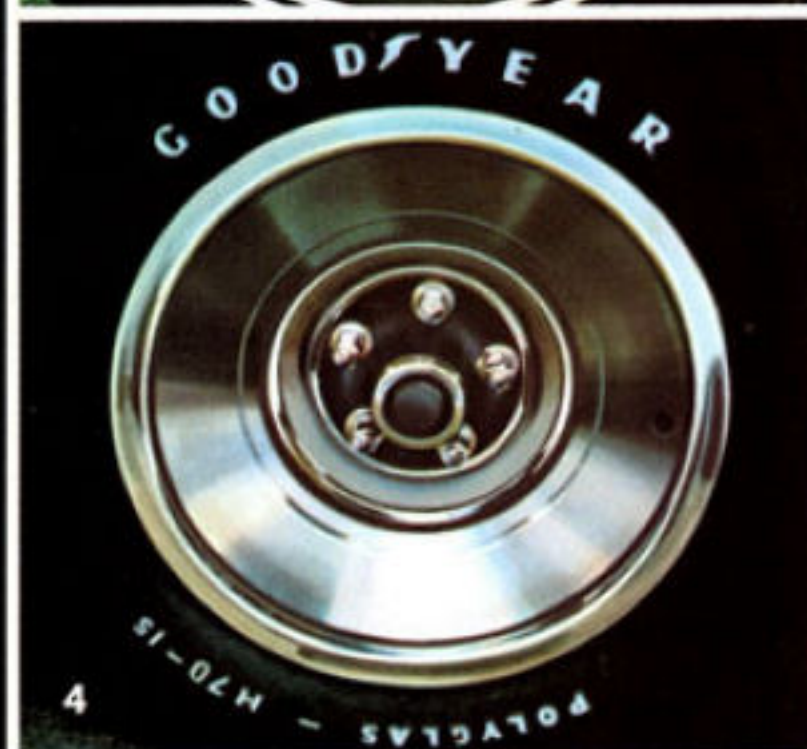
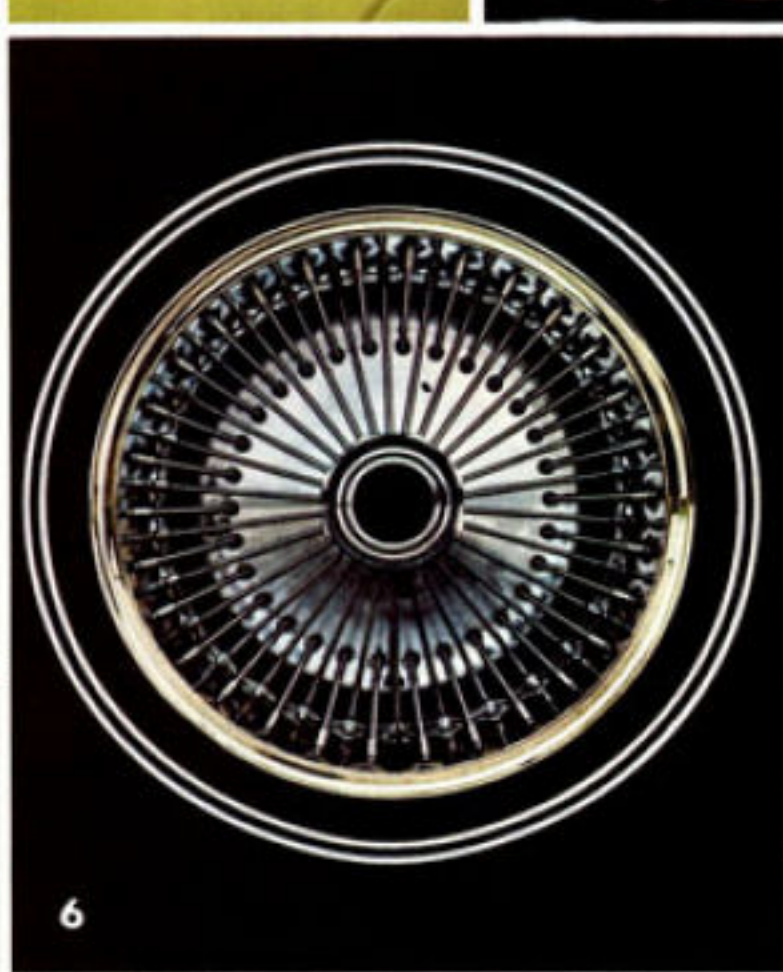
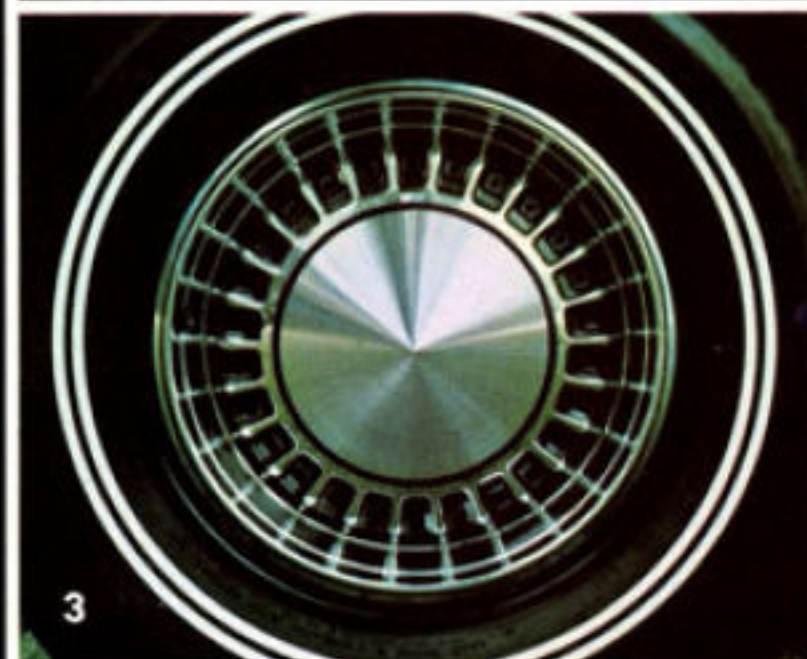
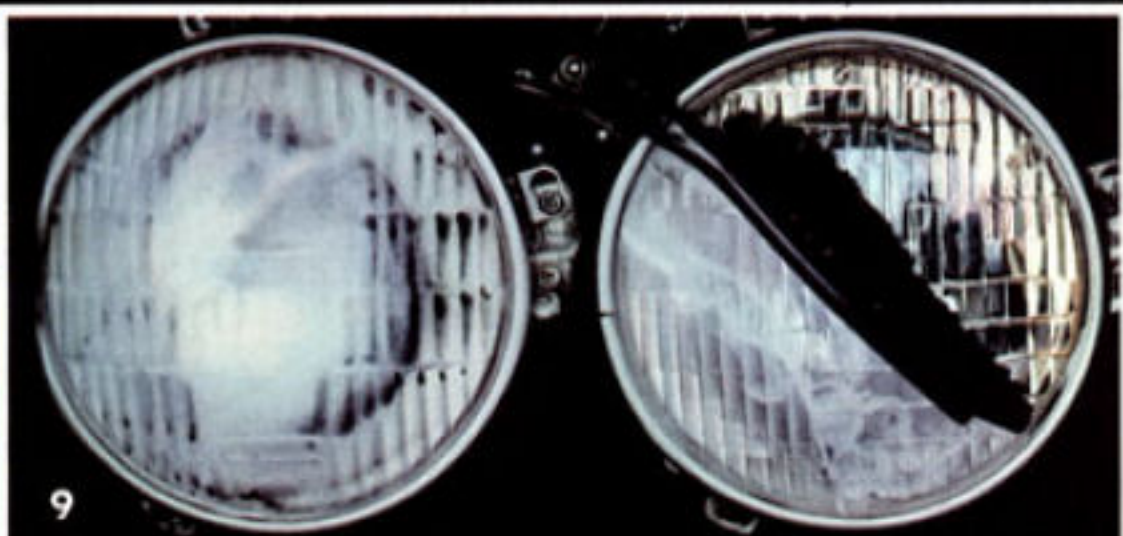

1971 Plymouths

FURY

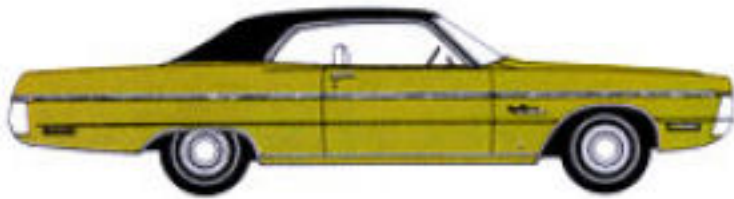

Sport Fury (4-door sedan and hardtop, 2-door hardtop and formal hardtop—V-8)

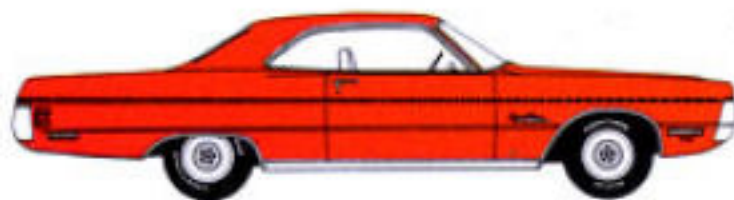

Sport Fury GT (2-door hardtop—V-8)



Fury III (2-door formal hardtop, 4-door hardtop—V-8; 4-door sedan and 2-door hardtop—V-8 or Six)



Fury II (2-door hardtop and 4-door sedan—V-8 or Six)

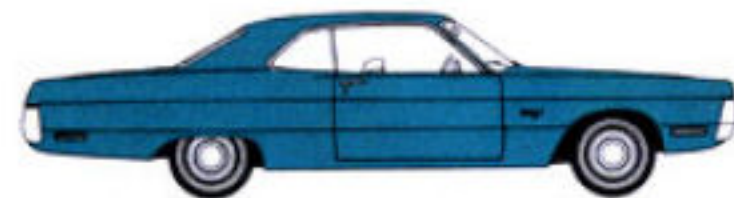

Fury I (2-door coupe and 4-door sedan—V-8 or Six)



Fury Wagons (Sport Suburban 2- and 3-seat models—V-8) (Custom Suburban 2- and 3-seat models—V-8) (Suburban 2- and 3-seat models—V-8)

SATELLITE



Satellite Sebring (Sebring-Plus 2-door hardtop—V-8) (Sebring 2-door hardtop—V-8 or Six)

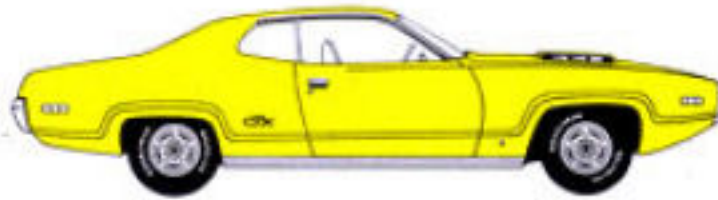

GTX (2-door hardtop—V-8)



Road Runner (2-door hardtop—V-8)



Satellite (2-door coupe—V-8 or Six)



Satellite Brougham (4-door sedan—V-8) (Satellite Custom 4-door sedan—V-8 or Six) (Satellite 4-door sedan—V-8 or Six)



Satellite Wagons (Satellite Regent 2- and 3-seat models—V-8) (Satellite Custom 2- and 3-seat models—V-8 or Six) (Satellite 2-seat—V-8 or Six)

BARRACUDA



Barracuda Gran Coupe (2-door hardtop—V-8)



Barracuda (convertible, 2-door hardtop—V-8 or Six) (Barracuda 2-door coupe—V-8 or Six)



'Cuda (convertible, 2-door hardtop—V-8)

VALIANT



Duster (2-door coupe—V-8 or Six) (Duster 340 2-door coupe—V-8)



Scamp (2-door hardtop—V-8 or Six)



Valiant (4-door sedan—V-8 or Six)

All product illustrations and specifications are based on authorized information. Although descriptions are believed correct at publication approval, accuracy cannot be guaranteed. Some of the equipment shown on product illustrations is optional, at extra cost. Chrysler Motors Corporation reserves the right to make changes from time to time, without notice or obligation, in prices, specifications, colors and materials, and to change or discontinue models. Specifications and product descriptions apply to North American-built vehicles only.



customer
care

Keep your Plymouth coming through in top condition. Service it with men who know it best. See your Plymouth Dealer.

Plymouth

