

'73 FORD PINTO

2-Door Sedan • 3-Door Runabout • Wagon



1973 FORD PINTO BACK TO BASICS

2-DOOR SEDAN 3-DOOR RUNABOUT WAGON

Quality and Experience. Ford is a very experienced small car manufacturer. We've been building small, dependable, economical cars from the early days of the Model "T" and Model "A" down through the current Cortina, Taunus and Capri of Europe. Ford's subcompact Pinto is another simple, solid car in this long, successful heritage. It is well engineered to give you reliable, comfortable, 4-passenger car transportation at very little cost. Pinto is durable and economical. It's built into all three Pintos—2-Door, 3-Door Runabout and Wagon—because durability and economy represent basic value. That's a major reason for selecting Pinto for your driving requirements. *Basic value* is simply getting your money's worth. Pinto does that, and more. Here's why:

Dependability. Every 1973 Pinto is equipped with the same type of rugged 4-cylinder engine that has been proven through millions of miles throughout the world. The starter motor, ball and universal joints, and rear wheel bearings are heavy duty. The brake lines have a special rust-resistant coating. The Pinto body is welded solid. It is then electrocoated against rust and corrosion and painted five more times to provide greater durability and less maintenance.

Economy of Operation and Maintenance. We've made Pinto easy to maintain. Normally, Pinto calls for 36,000 miles, or 3 years, between major chassis lubrications and oil filter changes initially at 4,000 miles (or 4 months) and 8,000 miles (or 8 months) thereafter. Other service-savers include 2-year engine coolant anti-freeze, self-adjusting brakes, long-life Motorcraft Sta-Ful battery, corrosion-resistant aluminized muffler, zinc-coated underbody parts, and more. Pinto is also a do-it-yourself car. Lots of Pinto owners will find it easy to clean or replace spark plugs, air cleaner, fuel and oil filters and many other Pinto-simple maintenance jobs.

Stability and Maneuverability. Pinto ball joint suspension system and wide, stable stance on the road provide positive handling in every road situation. Because Pinto's stance is lower and wider than most other cars, you get

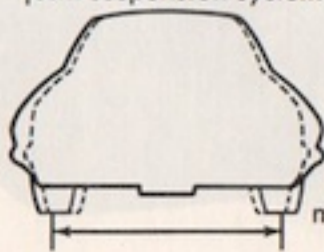

excellent balance on turns and in high crosswinds. Pinto's rack-and-pinion steering is the same kind as on expensive European sports cars.

It's standard equipment on Pinto and it makes turning, parking and cornering easier. Please note, too, that it's exclusive. You won't find it on any other domestic compact car.

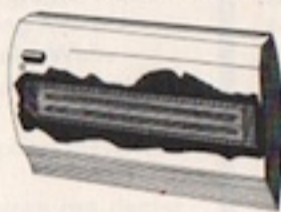

Safety. To help protect you and your passengers, Ford Motor Company Lifeguard Design Safety Features are built into all 1973

Pintos. There are Steel Guard Rails in side doors, which help absorb side impact forces. One-snap Uni-Lock Shoulder/Lap Belts with Reminder System, and more. In addition, there's an Energy-Absorbing



Bumper System that meets 1973 Federal Safety Standards. You'll find a complete listing of all the Pinto Lifeguard Design Safety Features on the back cover.



You Can Tailor Each Pinto. Innovative Ford Engineers give you one of the greatest opportunities in the industry to tailor your Pinto to suit special driving needs. An extensive selection of special options is included in this catalog. You can start with a model choice of 2- or 3-Door Pinto or Pinto Wagon. In the



2- and 3-door you can insert a friskier 2000-cc. engine (standard on wagon). A SelectShift Cruise-O-Matic transmission lets you shift manually or automatically as you wish. You can add an Accent Group, Luxury Decor Group, Squire Option for the

Pinto Wagon, Sunroof, vinyl roof, Steel-Belted Radial Tires, and lots of other options well worth thinking about. Pinto's wide array of choices is listed on pages 12 and 13. But even without these special design elements, Pinto is a neat, tough little car. It's a result of Ford knowledge, experience and quality manufacturing.

**Listening better.
Building better.
That's Ford.**

*All 1973 Pinto engines are designed to operate on regular gasoline with an octane rating of at least 91 (Research Method) when the engine is adjusted to factory recommended specifications.

FOR BASIC VALUE...
LOOK TO PINTO



So much for so little. That's value. When it's super-easy to buy and maintain, that's economy. The 1973 Pinto is that kind of car. Basic, dependable value at low initial cost. Pennies to operate. A stable, reliable traveler on the highway. And, big enough for people of just about any size. Basically, that's Pinto for 1973. In 1973, there's a Pinto model to fit every subcompact buyer's budget. The basic Pinto 2-Door Sedan is all economy with lots of basic value. The 3-Door Runabout gives you extra load room and extra utility. The 1973 Pinto Wagon is the biggest little Pinto family member, yet has the same sensible, solid value plus room and extra engine muscle.

You get your money's worth in a Pinto because the basics are hard to beat. Especially basic ideas. And basic values. And basic fun. And Pinto for 1973 is still basic dependability and economy.

COMFORTABLE, ROOMY INTERIORS

Pinto value is much more than skin deep. The inside story is value, too. Whichever Pinto model you choose, you'll be surprised at its roominess. It's designed to comfortably seat four big people. The Pinto 2-Door basic interior (shown in the styling display at left. Color: A8) consists of cushy, front High Back vinyl bucket seats with energy-absorbing front seat back, full-width molded rear seat, color-keyed vinyl door panels, floor mats and Mini-console. Slip into the interior of a 1973 Pinto today. See if you don't fall in love with the little rascal.

OPTIONS SHOWN

- Accent Group (shown on 2-Door Sedan, described on page 12).
- Sports Accent Group (shown on 3-Door Runabout, described on pages 9 and 13), Sunroof, Dual Racing Mirrors, Forged Aluminum Wheels, White Sidewall Tires and Deluxe Bumper Group.
- Pinto Wagon Squire Option (described on page 11).
- License plate frames shown are dealer accessory.
- Belted Wide Oval Tires with Raised White Letters shown on Runabout not currently available.

For your convenience, each Pinto illustration is color coded, example: (Color 3D). Your Ford Dealer will be pleased to show you a color chip and actual swatches of vinyl roof and interior trim materials.



Basic Pinto 2-Door Sedan with exciting Accent Group. (Color 3D.)



Pinto 3-Door Runabout with Manual Sunroof and Sports Accent Group. (Color 9A with Avocado.)



Practical Pinto Wagon with smart Squire Option. (Color 6E.)

FORD PINTO 2-DOOR SEDAN



Pinto 2-Door Sedan. Lowest-priced Pinto for 1973. (Color 2B.)



Pinto 2-Door Sedan with Luxury Decor Group, Vinyl Roof and Manual Sunroof. (Color 5L)

FORD PINTO 2-DOOR SEDAN

For your convenience, each Pinto illustration is color coded, example: (Color 3D). Your Ford Dealer will be pleased to show you a color chip and actual swatches of vinyl roof and interior trim materials.

When you make a solid, sensible, economical little car like Pinto, you only change it to make it better. The Pinto 2-Door is the one that started it all and it's still the only little subcompact car that doesn't look like a little subcompact car. Or act like one. Pinto's solid, spunky 1600-cc. OHV engine kicks out plenty of power for highway cruising or stop-and-go city traffic. And it does it with the same kind of economical mileage on regular gas as the little imports. The smooth, fully synchronized 4-speed transmission, sports car rack-and-pinion steering and ball joint suspension make Pinto a very sensible little car. Service intervals call for 4,000 miles between oil changes. You can pamper Pinto, too. There's an extensive list of options on pages 12 and 13. A few to think about are a huskier 2000-cc. overhead cam engine, manual front disc brakes, SelectShift Cruise-O-Matic transmission and Steel-Belted Radial Ply Tires. But if it's strictly basics, Pinto's it. That's the way it was designed—to handle the needs of the subcompact buyer—to be economical, durable, dependable, to be more than just good looking. Designed to fit a budget, to be more for your money. And, most important, to be a little wonder.

LUXURY DECOR GROUP Interior:

A little charm never interferes with economy and dependability. The optional Luxury Decor Group (illustrated top right), really spices up Pinto. Shown here in Ginger, highlights consist of "super-soft" vinyl trim with either pleated vinyl or cloth inserts and cut-pile carpeting. The instrument panel features bright dress-up trim with woodtone accents. **Exterior:** Consists of rocker panel molding, lower back panel periphery molding, plus all of the features of the Accent Group which include bright door and quarter window frames, belt, center pillar and drip rail moldings, wheel covers, wheel lip molding and black vinyl insert bodyside protection molding. (Complete description page 12.)



Luxury Decor Group Interior.

Neatly finished luxury in "super-soft" vinyl trim with choice of pleated vinyl or cloth inserts, warm, practical cut-pile carpeting. Color: CF

STANDARD FEATURES:

2-Door Pinto. 4-cylinder 1600-cc. 1V OHV engine • full-sync, 4-speed transmission • high back, contoured all-vinyl front seats • reversible keys, "keyless" locking • floor mats • DirectAir Ventilation • 3-speed heater • Mini-console • 6.00x13 BSW tires • slotted argent wheels and hub caps • Energy-Absorbing Bumper System • front bumper guards • parking lamps • bright backlite/windshield moldings • plus all Ford Motor Company Lifeguard Design Safety Features including side door Steel Guard Rails and Uni-Lock shoulder/ lap belts with the new reminder system.

Mini-Console.

A convenient color-keyed "saddle bag" for maps, sunglasses, gloves, etc.



OPTIONS SHOWN

Deluxe Bumper Group, White Sidewall Tires, Luxury Decor Group, Convenience Group, Vinyl Roof, Sunroof (all on Pinto, center). SelectAire and AM Radio. License Plate Frames shown are Dealer accessory.

SPECIFICATIONS: 2-DOOR PINTO

Wheelbase.....	94.2"	Legroom.....	31.5"
Tread (front/rear).....	55.0"	Shoulder room.....	51.6"
Overall length.....	164.5"	Hiproom.....	41.5"
Overall width.....	69.4"	*Front seat in rearmost position	
Overall height.....	49.6"	Luggage: (usable capacity)	
Curb wt. (w/1600-cc.).....	2210 lb.	2-Door.....	5.9 cu. ft.
The Front Compartment:*		The OHV Four 1600-cc.:	
Effective headroom.....	37.5"	Carburetor.....	1V
Legroom.....	41.0"	Compression ratio.....	8.0 to 1
Shoulder room.....	52.5"	Bore and stroke.....	3.19" x 3.06"
Hiproom.....	51.8"	Fuel capacity and grade.....	approx. 11 gal., regular
The Rear Compartment:*		Oil capacity.....	3.5 qt.
Effective headroom.....	36.3"	Transmission.....	4-speed manual floor shift



Pinto 3-Door Runabout—practicality and style combined with Luxury Decor Group. (Color 5H.)

Adding a rear door and a seat that folds down to a Pinto that's already practical, makes it even more practical. For handy hauling. For

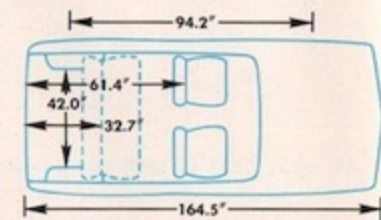

handy loading. That's the Pinto 3-Door Runabout. The easy handling, pneumatic-operated extra door gives you a cargo area of up to 41.3 cu. ft. With the rear seat folded down Runabout's carpeted flat floor is five feet long (from rear bumper to front seat back). Everything else is the same. Solid, sensible, durable, economical Pinto. Its responsive 1600-cc.

OHV engine gives you the same kind of economical mileage on regular gas as the little imports. And Pinto packs the performance to accelerate uphill and cruise long distances all day. The 4-speed transmission is

rock solid. Sports car rack-and-pinion steering puts authority in parking, cornering and turning. Pinto's ball joint suspension and wide, stable stance make remarkable road adhesion. Another

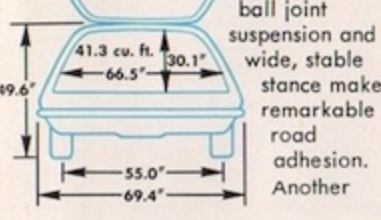

Pinto basic is that service intervals call for 4,000 miles between oil changes. Attractive alternatives in Pinto designability are the optional 2000-cc. engine which is bigger and beefier. Manual front disc brakes, SelectShift Cruise-O-Matic automatic transmission, SelectAire conditioner, Luxury Decor Group, and others.

SPORTS ACCENT GROUP
Think dazzle! Then lay an optional Sports Accent Group on your Pinto. Available in White with Orange or Avocado lower bodyside

Fold-Down Seat with carpeted load area.

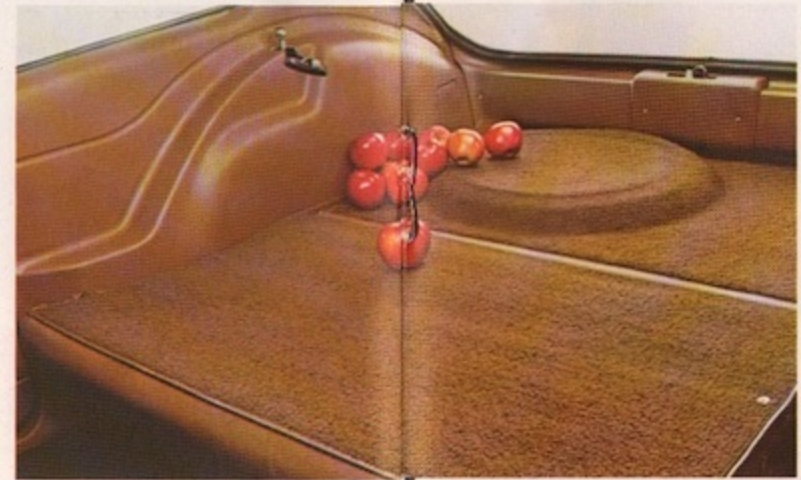

paint/tape treatment with matching vinyl roof, cut-pile carpeting, "super-soft" vinyl trim, deluxe door trim panels, and an instrument panel with bright dress-up trim, parking brake and transmission bezel accents and deluxe steering wheel with woodtone insert. See the complete description on page 13.

argent wheels and hub caps • Energy-Absorbing Bumper System • front bumper guards • parking lamps • bright backlite/windshield moldings • plus all Ford Motor Company Lifeguard Design Safety Features including side door Steel Guard Rails and Uni-Lock



Pinto 3-Door Runabout. Cargo-ready for hauling or cruising with Sports Accent Group (pages 7 and 13). (Color 9A with Orange.)

STANDARD FEATURES:

- 3-Door Pinto Runabout. 4-cylinder 1600-cc. 1V OHV engine • full-sync, 4-speed manual transmission • high back, contoured all-vinyl front seats • reversible keys, "keyless" locking • DirectAire Ventilation • 3-speed heater • Mini-console • fold-down rear seat • color-keyed carpeting in passenger compartment and load area • liftgate • 6.00 x 13 BSW tires • slotted

Shoulder/Lap Belts with reminder system—positive reminder warning light and buzzer sounds when you shift into a moving gear, reminding front occupants to buckle up.

Sports Accent Group Interior. (Color BC.)



OPTIONS SHOWN

Luxury Decor Group (on left Pinto, described on pages 7 and 12), Sports Accent Group (above), White Sidewall Tires, Deluxe Bumper Group, Dual Racing Mirrors, Forged Aluminum Wheels, License Plate Frames shown are Dealer accessory.

For your convenience, each Pinto illustration is color coded, example: (Color 3D). Your Ford Dealer will be pleased to show you a color chip and actual swatches of vinyl roof and interior trim materials.

SPECIFICATIONS: 3-DOOR PINTO RUNABOUT

Wheelbase	94.2"	Shoulder room	51.6"
Tread (front/rear)	55.0"	Hiproom	41.5"
Overall length	164.5"	*Front seat in rearmost position	
Overall width	69.4"	Luggage: (usable capacity)	
Overall height	49.6"	3-Door w/rear seat folded down, volume	
Curb wt. (w/1600-cc.)	2254 lb.	41.3 cu. ft.	
The Front Compartment:*			
Effective headroom	37.5"	The OHV Four 1600-cc.:	
Legroom	41.0"	Carburetor	
Shoulder room	52.5"	Compression ratio	
Hiproom	51.8"	Bore and stroke	
		Fuel capacity	
		and grade	
		approx. 11 gal., regular	
		Oil capacity	
		3.5 qt.	
		Transmission-4-speed manual floor shift	

FORD PINTO 3-DOOR RUNABOUT

The 1973 Pinto Wagon—a chip off the old Wagonmaster's block. And built with the same simple, basic values that are Ford and Pinto traditions. The 1973 Pinto Wagon is long on function because it's almost ten inches longer than the 2- and 3-door models. With the rear seat folded down, there's a floor space length of almost six feet and a volume of over 60 cu. ft. Loads of luggage, groceries or even a bale of hay can fit conveniently in the cargo area. Counterbalanced supports for the full upswinging liftgate help make loading easier. But cargo isn't everything in a station wagon. Comfort, dash and maneuverability on or off the beaten track is just as important. Pinto's got it. Wide stance, stable comfort on roads that feature bumps and high winds, 2000-cc. engine punch for any turnpike, and rack-and-pinion steering for zip-quick, nimble turns. Front disc brakes are standard and there's a new Energy-Absorbing Bumper System to give greater protection to the car. Service intervals call for 4,000 miles between oil changes. If you're keen on options, Pinto has a wide range to do the job: Select-Shift



Pinto Wagon with classic Squire Option. (Color 4P.)

Cruise-O-Matic automatic transmission, SelectAire Conditioner, Steel-Belted Radial Ply Tires, luggage rack, and lots more listed on pages 12 and 13. In every Pinto you have the basics: dependable, reliable, durable, sensible. The 1973 Ford Pinto Wagon is a stout little

FORD PINTO WAGON

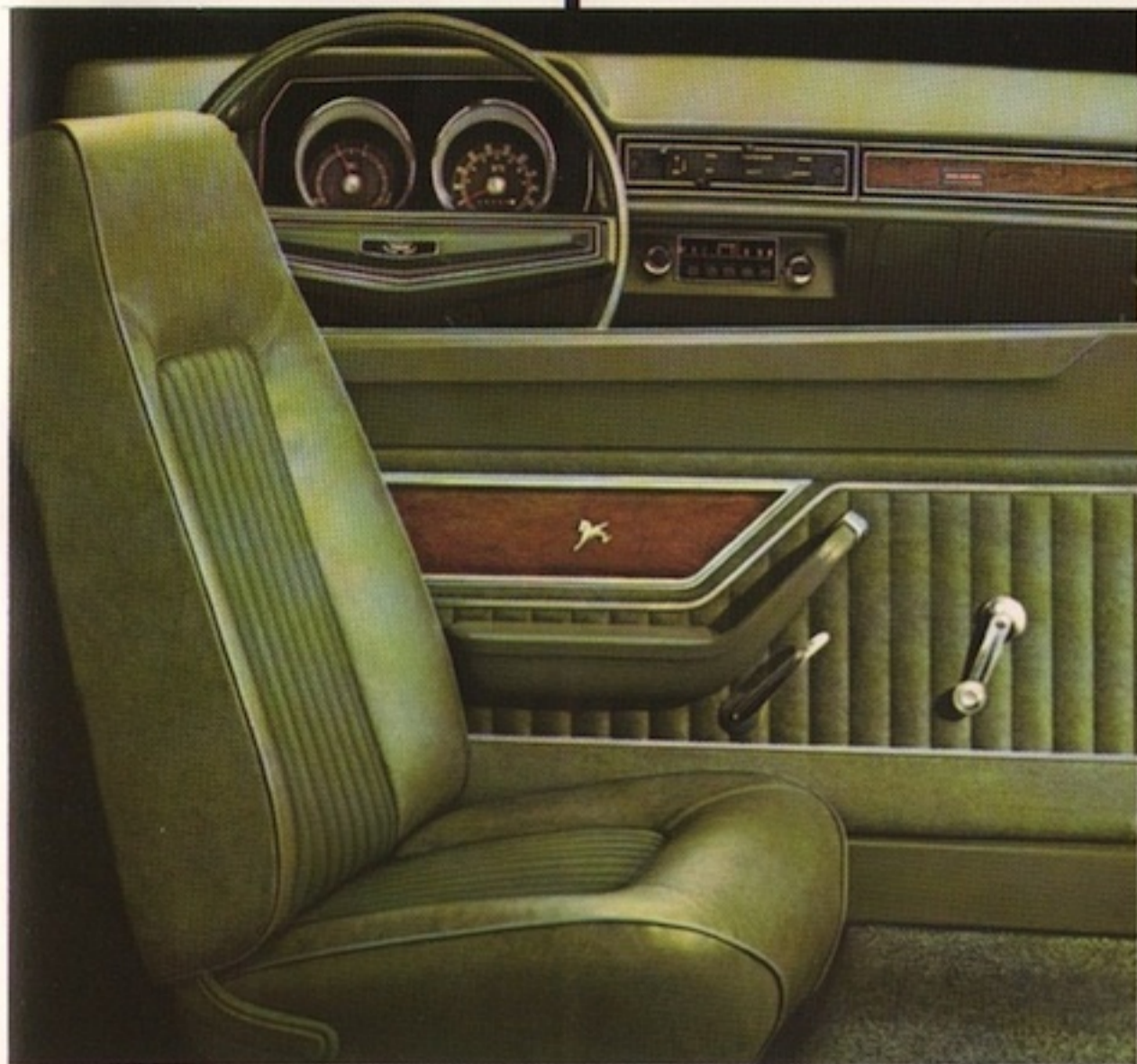

Beautiful Squire Option Interior. (Color CG.)

wagon. It's the wagon to take you out where the zest begins.

PINTO SQUIRE OPTION

Sophisticated simplicity for a solid, sensible, carefree little car. The Squire Option is just that. And, it's in the finest Wagonmaster tradition of Ford and Torino Squire models. The Squire Option has deluxe wheel covers and elegant woodgrain paneling on the bodysides and liftgate. The Squire Option interior, shown in Avocado, consists of comfort-molded "super-soft" vinyl seats with your choice of pleated vinyl or Manston cloth inserts; cut-pile carpeting; deluxe shoulder/lap belts; deluxe door trim

STANDARD FEATURES:

Pinto Wagon. 4-cylinder 2000-cc. 2V OHC engine • full-sync, 4-speed manual transmission • manual front disc brakes • fold-down rear seat • color-keyed passenger and cargo carpeting • high back, contoured front all-vinyl seats • reversible keys, "keyless" locking • DirectAire Ventilation • 3-speed heater • Mini-console • A78 x 13 non-belted BSW tires • full upswinging liftgate with fixed backlite • bright window and belt moldings • rear flipper quarter windows • slotted argent wheels and hub caps • new Energy-Absorbing

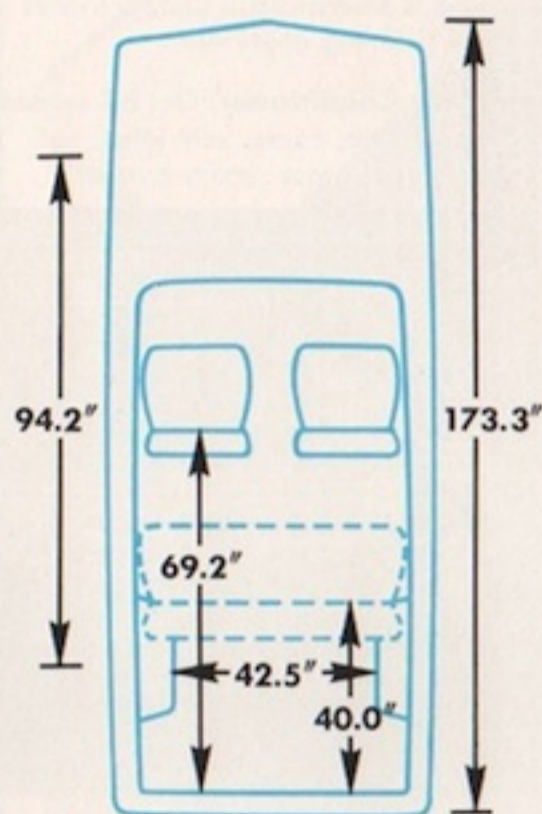
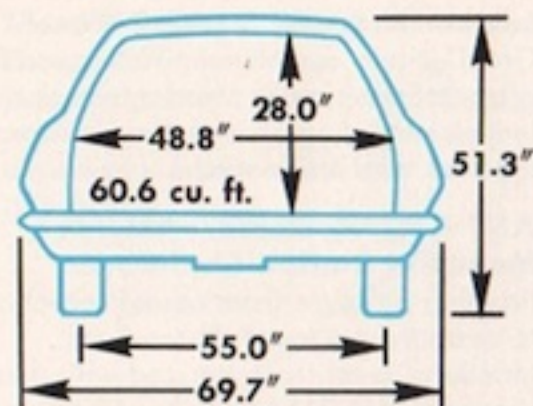

with reminder system—positive reminder warning light and buzzer automatically starts when you shift into a moving gear, reminding front occupants to buckle up for safety.

SPECIFICATIONS: PINTO WAGON

Wheelbase	94.2"	Shoulder room.....	51.6"
Tread (front/rear).....	55.0"	Hiproom	41.5"
Overall length.....	173.7"	<i>*Front seat in rearmost position</i>	
Overall width.....	69.7"	Luggage: (usable capacity)	
Overall height.....	51.3"	Wagon w/rear seat	
Curb wt.....	2497 lb.	folded down..... 60.6 cu. ft.	
The Front Compartment*:			
Effective headroom.....	38.8"	The OHC Four 2000-cc.:	
Legroom.....	41.0"	Carburetor..... 2V	
Shoulder room.....	52.5"	Compression ratio..... 8.0 to 1	
Hiproom.....	51.8"	Bore and stroke..... 3.58" x 3.03"	
The Rear Compartment*:			
Effective headroom.....	39.6"	Fuel capacity and	
Legroom.....	31.5"	grade..... approx. 11 gal., regular	
		Oil capacity..... 5 qt.	
		Transmission 4-speed manual floor shift	

For your convenience, each Pinto illustration is color coded, example: (Color 3D). Your Ford Dealer will be pleased to show you a color chip and actual swatches of vinyl roof and interior trim materials.



Pinto Wagon with Accent Group. (Color 3B.)

OPTIONS SHOWN

Pinto Wagon Squire Option, AM Radio, Dual Racing Mirrors (shown with Squire Option) Luggage Rack, Accent Group, Steel-Belted Radial Ply White Sidewall Tires, Deluxe Bumper Group.

Bumper System • front bumper guards • parking lamps • plus all Ford Motor Company Lifeguard Design Safety Features including side door Steel Guard Rails and Uni-Lock shoulder/lap belts

panels; cargo light, cigar lighter and rear ash tray; passenger-side door

courtesy light switch; bright trim and woodtone instrument panel; transmission shift bezel, parking brake with woodtone grip and deluxe 2-spoke steering wheel.

FORD PINTO BETTER IDEA OPTIONS

Pinto. Economical. Dependable. Durable. Reliable. And lots more lovable when it's personalized by you. Pinto Better Idea options enable you to design more practical styling accents and functional conveniences into your Pinto. Go mild or wild. Dress it practical or add easy elegance. You can take the plunge for very little on a good little car like Pinto. Get an early start by checking out the Pinto options today.

Luggage Rack. Convenient for carrying just about everything. All models except with Sunroof.



Lower Bodyside Paint/Tape Treatment. Tutone lower bodyside paint/tape treatment adds emphasis to Pinto styling. Front and rear valance panels and lower back panel are also painted in matching colors. Also includes bright back panel periphery molding.

Accent Group. Nice touch and includes bright door and quarter window frames, belt, center pillar and drip moldings (available on 2- and 3-door only), wheel covers, wheel lip molding and black vinyl insert bodyside protection molding.

Protection Group. Great protection for your Pinto in parking and tight traffic situations. Includes bodyside molding

Leather-Wrapped Steering Wheel. Great grip to complement Pinto's road grip. Deluxe 2-spoke steering wheel with leather wrapping around the rim. Sewn together with a fine stitch.

AM, AM/FM Stereo, AM/FM Monaural Radios. Choose your listening pleasure from casual reception to wraparound sound. Philco-Ford Monaural is all-transistorized with dual speakers. AM/FM Stereo has twin speakers for proper stereo effect. AM radio is all-transistorized, provides complete listening enjoyment.

SelectAire Conditioner. Get all-season comfort. Warms, cools, ventilates, defrosts. Tinted glass recommended.



SelectShift Cruise-O-Matic Transmission. Shift manually or automatically with this smooth 3-speed, floor-mounted transmission. Available only with 2000-cc. engine.

2000-cc. Engine. A mighty option, this rugged engine is a 4-cylinder overhead-cam type, with a 2-barrel carburetor and 8.0 to 1 compression ratio. It comes with the standard 4-speed manual transmission or optional SelectShift Cruise-O-Matic. It's standard on Pinto Wagon.

Starter Interlock. Consists of an electrical system which will not permit the engine to start unless the driver's seat belt (and/or the front passenger's seat belt) is fastened.



Metallic Glow Paint. Three glamour colors are available. Magic spangle in Blue Glow, Ivy Glow and Gold Glow.

Vinyl Roof. Sporty, distinguished flair for a 2-Door or 3-Door Runabout. It's available in Black, White and Avocado and includes bright drip moldings.

with black vinyl inserts, rear bumper guards, rubber inserts on front and rear bumper guards, bumpers with wraparound rub strips, and anti-theft spare tire lock.



Luxury Decor Group. Interior:

Consists of "super-soft" vinyl trim with either pleated vinyl or cloth inserts, deluxe door trim panels, cut-pile carpeting, deluxe shoulder/lap belts, cigar lighter and rear ash tray. The instrument panel and quarter trim panels feature bright dress-up trim with woodtone accents, woodtone accents on the parking brake and transmission bezel, color-keyed parking brake boot, multi-directional vent register, passenger-side door courtesy light switch and deluxe steering wheel with woodtone insert.

Exterior: Consists of rocker panel molding, lower back panel periphery molding, plus all of the features of the Accent Group (see details on this page).

Convenience Group. Package consists

of deluxe shoulder/lap belts, day/night inside mirror, LH remote-control color-keyed racing mirror, and glove box lock.

Color-Keyed Dual Racing Mirrors. A sporty touch with added convenience. The left hand mirror is remote controlled.





Flipper Rear Quarter Windows. Simple, functional design with bright moldings, easy-to-open and close. Rattle-resistant, positive-locking, tight-sealing. (Standard on Wagon.)

Deluxe Wheel Covers. Snappy Deluxe Wheel Covers shown with optional Steel-Belted Radial Ply white sidewall tires.



Forged Aluminum Wheels. The ultimate in sporty, racy flair with the look of performance shown with optional A78-13 non-belted white sidewall tires.



Rear Window Electric Defrost. No more scrapers. Flip a switch and frost and ice disappear. Includes tinted glass.

Trim Ring/Hub Caps. More dash for your Pinto with trim ring/hub caps shown on optional A70 x 13 belted Wide Oval black sidewall tires with raised white letters.



Steel-Belted Radial Ply White Sidewall Tires. 175R x 13 radials. Also available in Black Sidewalls.

Manual Sunroof. A sunroom on wheels. Designed for the 2-Door and 3-Door Runabout models. A unique sliding steel panel which is easily opened and closed with a convenient turn of a handle.



Sports Accent Group. Consists of a lower bodyside paint/tape treatment in Orange (page 9) or Avocado (below) with matching vinyl roof, WSW radial ply tires, wheel lip moldings, wheel covers,



bright door and quarter window frames, belt, center pillar and drip moldings, cut-pile carpeting, "super-soft" vinyl trim with cloth inserts, deluxe door trim panels, deluxe shoulder/lap belts and rear ash tray. The instrument panel and quarter trim panels feature bright dress-up trim with woodtone accents, woodtone accents on the parking brake and transmission bezel, color-keyed parking brake boot, multi-directional vent register, cigar lighter, passenger-side courtesy light switch, and deluxe steering wheel with woodtone insert.

Trailer Towing Package. Your Pinto can tow trailers up to 800 pounds gross, 100-lb. tongue load with this option. It includes extra-cooling radiator with radiator shroud. SelectShift transmission, 2000-cc. engine and front disc brakes are required with this option.

OTHER OPTIONS:

Tinted Rear Window. Reduces glare for Runabout's enlarged rear window.

Tinted Glass. Reduces glare all the way around on all Pinto models. A must with SelectAire Conditioner.

Handling/Suspension Option. For harder working 2-Door Sedan and 3-Door Runabout models with 2000-cc. engine. Includes heavy-duty springs, shock absorbers and front stabilizer bar.

Manual Front Disc Brakes. The same system that stops jets, stops Pinto. (Standard on Wagon; required with 2000-cc. engine.)

Color-keyed carpeting (2-Door Sedan only, standard on 3-Door and Wagon). HD battery. Rocker panel molding. Door edge guards.



FORD CARES ABOUT YOUR SAFETY

Ford has been a pioneer in safety design in the automotive industry. Our Safety Research Center has developed stronger, safer, more dependable automotive products for you.

You'll find this reflected in each new 1973 Pinto model which includes these FORD MOTOR COMPANY LIFEGUARD DESIGN SAFETY FEATURES, standard: Improved front and rear bumpers • Improved impact-absorbing laminated safety glass windshield • Dual hydraulic brake system with warning light • Glare-reduced instrument panel padding, windshield wiper arms, steering wheel hub, rearview mirror/mirror mounting and windshield pillars • Energy-absorbing steering column and steering wheel • Energy-absorbing armrests and safety-designed door handles • Front and rear lap belts with mini buckles for all seating positions and retractors for front and rear outboard occupants • Shoulder belts for front outboard occupants • Positive reminder warning light and buzzer for front outboard seat belts • Turn indicators with lane-changing signal feature • Inside yield-away rearview mirror • Energy-absorbing instrument panel with padding for center and outboard passengers • Padded sun visors • Locking steering column with warning buzzer • Two-speed windshield wipers • Windshield washers • Double-yoke safety door latches and safety hinges • Steel guard rails in side doors • Hazard warning flasher • Backup lights • Side marker lights • Energy-absorbing front seat back tops with padding • Self-locking front seat backs on two-door vehicles • Safety-designed coat hooks • Safety-designed radio control knobs and push buttons (on all cars equipped with radios) • Outside rearview mirror, driver's side • Safety rim wheels and load-rated tires • Corrosion-resistant brake lines • Uniform transmission shift quadrant (on Pintos equipped with SelectShift) • Parking lamps coupled with headlamps • Non-reversing odometer • Safety design front end structure • Head restraints or high back seats for front outboard occupants • Safety glove-box latch

(on all cars equipped with glove boxes).

Built-in safety is something you have going for you in every Pinto. Take full advantage of this protection as you drive. Obey all traffic laws, think ahead and always buckle up for safety.

Economy of Operation: All 1973 Pintos call for 36,000 miles, or 3 years, between major chassis lubrications. 4,000 miles or 4 months (whichever comes first) between oil changes. Oil filter change initially at 4,000 miles or 4 months, and at 8,000-mile or 8-month intervals thereafter. Other economy features include: self-adjusting brakes, 2-year engine coolant-antifreeze, long-life Motorcraft Sta-Ful battery, corrosion-resistant aluminized muffler, zinc-coated underbody parts, use of regular gas, and more.

NOTES

Color Codes. For your convenience, each Pinto illustration is color coded, example: (Color 3D). Your Ford Dealer will be pleased to show you a color chip and actual swatches of vinyl roof and interior trim materials.

All 1973 Pinto engines are designed to operate on regular gasoline with octane rating of at least 91 (Research Method) when adjusted to factory recommended specifications.

Replacement Parts. Your 1973 Pinto comes with a factory-engineered Motorcraft battery, oil filter, shock absorbers; Autolite Powertip Spark Plugs and other Ford-approved precision parts. For continued top performance, be sure to specify Motorcraft Parts and Autolite Powertip Spark Plugs whenever replacement is necessary.

Illustrations and information presented were correct when approved for printing. Ford Division reserves the right to discontinue or change at any time, specifications or design without incurring obligations.

Some features shown or described are optional at extra cost. Most options are offered on all models. Some options are required in combination with other options. Availability of some models or features described may be subject to a slight delay. Always consult your Ford Dealer for the latest, most complete information on models, features, prices and availability.

All 1973 cars must meet Federal Emission Standards before sale. See your Ford Dealer for details.

Listening better.
Building better.
That's Ford.



2-Door Pinto Sedan (Color 6B.)

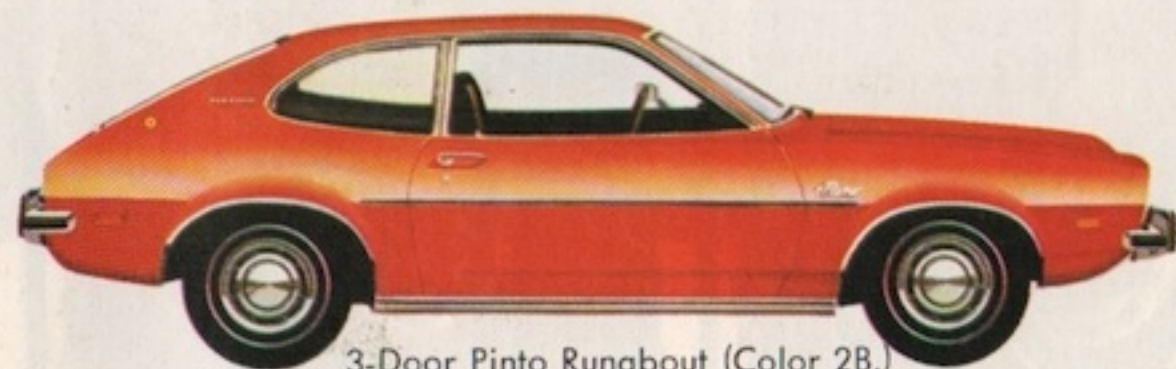

3-Door Pinto Runabout (Color 2B.)



Pinto Wagon (Color 4P.)



Pinto Wagon with Squire Option
(Color 5L.)

FORD PINTO

FORD DIVISION

