

# THE 1979 MERCURY MARQUIS



MIKE DILBER  
LINCOLN-MERCURY INC.  
130 KERCHEVAL AVE  
GROSSE POINTE FARMS, MI 48236  
PHONE 881-5000

NOTE: Some items are optional. See notable standard features, measurements, and color code reference listed throughout this catalog.



## THE ALL-NEW 1979 MERCURY MARQUIS. THE MOST SCIENTIFICALLY DESIGNED MARQUIS IN HISTORY.

### Contents

Mercury Marquis Dimensions	3
Mercury Grand Marquis	4-7
Grand Marquis Std. Features	4
Mercury Marquis Brougham	8-9
Mercury Marquis	10-11
Mercury Marquis and Colony	
Park Station Wagons	12-13
Mercury Marquis Options	14-15
Marquis Exterior Colors	14
Marquis Model Availabilities	16
Mercury Marquis Engineering	16

It began with a frame of mind . . . an idea to start with the frame of the car and design a totally new automobile. An entirely new vehicle that would take advantage of the many technological advances brought about by the space age, and still retain the styling excellence and luxury that you expect with Mercury Marquis.

For '79 Marquis offers its usual wide choice in models. Shown above is the Grand Marquis, the most elegant Marquis, which is also available as a

2-door model. Then there's the Marquis Brougham and the Mercury Marquis, each in two and four-door models, the Marquis Colony Park Station Wagon and the Mercury Marquis Wagon.

Mercury Marquis for 1979 is brand new. Its frame plus body units are new. Its base engine is new. Its suspension is new. You see a totally new car with many advantages over 1978.

**Room:** The '79 Marquis is actually bigger inside than in '78, with even more comfort for six passengers. It has more head and shoulder room, front and rear, and 3.4 inches more front hip room. Its trunk has more cubic feet of luggage volume with its new mini-spare tire.

**Ride:** Extensive computer analysis was used by designers to help provide an even distribution of stresses throughout the vehicle, and help control harshness and vibration. In addition, body, frame and suspension units were each expressly redesigned for this all new car, each complementing and harmonizing with the other so you have a new Marquis "ride package"—a new experience for you and your family.

**Steering:** The new for '79, 16.4:1 steering ratio for Marquis sedan provides more responsive steering and a four foot tighter turning diameter than '78—helps improve maneuverability.

**Command Seating:** You view the road from the vantage point of new re-engineered seating, enhanced by more glass area than in '78 to give you a commanding view of the road.

**Engines:** The standard engine for the new Mercury Marquis is the 5.0 litre (302 CID) V-8. The 5.8 litre (351 CID) V-8 is optional.

**Insulation:** We believe you'll find the 1979 Marquis, with its new sound insulation package, is a quiet experience on the road. The sound package, with carpet and insulation bonded and molded into one piece for good fit, surrounds the passenger compartment, forming a barrier that helps reduce external noise and temperature extremes.

Marquis Dimensions	2-Door Sedans	4-Door Sedans	4-Door Wagons
Overall Length	212.0"	212.0"	217.7"
Overall Width	77.5"	77.5"	79.1"
Wheelbase	114.4"	114.4"	114.3"
Wheel Tread—Front/Rear	62.2"/62.0"	62.2"/62.0"	62.2"/62.0"
Head Room—Front/Rear	38.0"/37.4"	38.0"/37.4"	38.9"/39.1"
Leg Room—Front (max.)/Rear (min.)	42.1"/40.6"	42.1"/40.6"	42.1"/39.3"
Hip Room—Front/Rear	61.2"/58.0"	61.2"/58.0"	61.2"/54.2"
Shoulder Room—Front/Rear	61.7"/61.0"	61.7"/61.7"	61.7"/61.7"
Luggage Capacity with Mini-Spare Tire (cu. ft.)	23.4	23.4	—
Station Wagon Cargo Space Behind Front Seat (cu. ft.)	—	—	91.9
Behind Rear Seat (cu. ft.)	—	—	53.4

## 1979 MERCURY GRAND MARQUIS. THE ULTIMATE IN MARQUIS LUXURY.

Pictured below is the Mercury Grand Marquis in dark cordovan metallic, one of twelve standard and four optional exterior paint choices. Note the refinement of the standard full vinyl roof in a harmonizing dark cordovan, one of ten available colors.

Power windows, power steering and power brakes represent just three of the many quality standard features that contribute to the ease of driving Grand Marquis.

**Grand Marquis standard features in addition to Marquis Brougham and Marquis standard equipment on pages 8 and 10 include:**

- Tinted glass throughout
- Coach lamps
- Twin Comfort Lounge seats
- Full-length door armrests w/wood-tone appliques and courtesy lights

### RIDE-ENGINEERED

- Luxury door panels, w/nylon carpet on lower areas, with pull straps
- Luxury steering wheel
- Visor vanity mirror
- Rear seat center armrest; pull straps and map pockets on front seat backs
- Fully carpeted luggage compartment
- Bodyside paint stripes
- Dome/Dual Beam Map Light

When you choose Mercury Grand Marquis, the plush elegance of Twin Comfort Lounge seats with individual center armrests are standard. You see them below in cordovan cloth, with optional leather-and-vinyl also available. Other interior color choices are dove grey, dark red, medium Wedgewood blue, pine green and camel. Note the tasteful trim on the door panels, highlighted with woodtone appliques on upper areas and carpeting below.

Other Grand Marquis interior elegance accents include woodtone appliques on the instrument panel. The Grand Marquis is equipped with a luxury steering wheel and two stalk-mounted controls (seen right) that provide finger-tip convenience when you activate windshield wiper/washer controls and turn signals. Also shown below right, the driver's side armrest with optional door lock controls.



Mercury Grand Marquis 4-door sedan in dark cordovan metallic

NOTE: Some items are optional. See notable standard features, measurements, and color code reference listed throughout this catalog.



Standard Grand Marquis Twin Comfort Lounge seat interior



Steering column-mounted controls



Door lock controls in driver's side armrest

Mercury Grand Marquis 2-door sedan in optional Tu-Tone



NOTE: Some items are optional. See notable standard features, measurements, and color code reference listed throughout this catalog.

Twin Comfort Lounge seat interior in grey leather-and-vinyl trim



## 1979 MERCURY GRAND MARQUIS. THE LOOK OF SUPERB DESIGN.

The distinctiveness of Grand Marquis exterior styling is evident in the crisp, sculptured lines of the 2-door sedan shown above in optional Tu-tone silver and medium grey metallic. Note the elegance afforded by the standard coach lamps, attractive bodyside paint stripe, and wide black and bright lower bodyside molding treatment. A new, driver's side, sail-mounted rear view mirror and landau vinyl roof are also standard.

The 1979 Mercury Grand Marquis still offers a fine blend of six-passenger roominess and luxury. Its shoulder room and front hip room offer six-passenger comfort, even for adults.

Grand Marquis spaciousness extends into the luggage compartment. It provides more cubic feet of luggage volume (23.4 cubic feet), with its

mini-spare, than even last year's Marquis, which had the largest trunk capacity available in any American car. And the Grand Marquis luggage compartment is fully carpeted.

Displayed above right is the Grand Marquis standard Twin Comfort Lounge seat interior in optional dove grey leather-and-vinyl trim. Cloth trim is standard. Other Grand Marquis standard interior features include full-length door armrests with woodtone appliques, rear seat center armrest, rear seat pull straps and map pockets.

The Grand Marquis instrument panel, shown below, features tastefully coordinated woodtone appliques to enhance interior luxury and a driver-convenient instrument cluster.

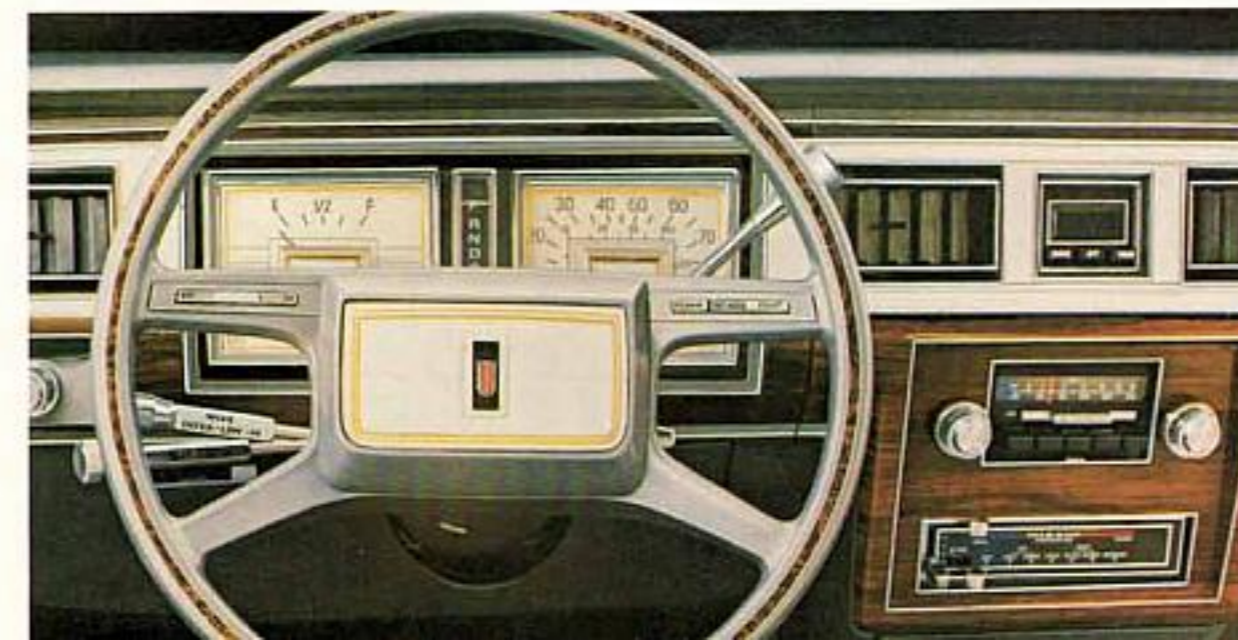

Optional Electronic AM/FM Stereo Search radio w/Quad-8 tape, and automatic temperature control



Analog clock



Marquis' spacious trunk

Convenience, comfort and luxury, which have always been Marquis hallmarks, continue to distinguish Mercury Marquis for 1979. An outstanding selection of options and

accessories provides you with multiple means of enhancing comfort and convenience and increasing driving pleasure. For example, there's the AM/FM/Multiplex Stereo Radio with Quad-8 Tape Player and search capability, shown above. This electronic radio "searches" for stations in the area in which you may be driving, a great convenience on long trips.

Also shown above, the Analog clock, and a view of Marquis' spacious luggage compartment.

Grand Marquis instrument panel and luxury steering wheel

NOTE: Some items are optional. See notable standard features, measurements, and color code reference listed throughout this catalog.



Sail-mounted remote control mirror



Twin Comfort Lounge seat w/RH and LH recliner



Electronic date/elapsed time digital clock

## 1979 MERCURY MARQUIS BROUGHAM.

In Marquis Brougham for 1979 the quiet elegance that means "brougham" is available as a 4-door or 2-door sedan. The Marquis Brougham 2-door is portrayed above in the optional medium red metallic Glamour paint and white-vinyl landau roof, which is standard on the 2-door Marquis Brougham. A full vinyl roof is standard on the Brougham 4-door.

The hood and decklid of the Marquis Brougham are set off with tasteful paint stripes. Lower bodyside

moldings and door frames are bright. Deluxe wheel covers and a sail-mounted left-hand rear view mirror are among the fine standard features for Marquis Brougham.

**Marquis Brougham standard features in addition to Marquis standard equipment on page 10 include:**

- Instrument panel and luggage compartment lights
- Power windows

- Sail-mounted LH remote control mirror
- Full vinyl roof on 4-door, landau vinyl roof on 2-door
- Wide, bright lower bodyside moldings
- Bright door frames
- Hood/decklid paint stripes
- Deluxe wheel covers
- Flight Bench seat in Ardmore cloth
- Analog clock
- Luxurious door trim
- 18 ounce Tiffany carpeting
- Full-length armrests
- Door pull straps
- Nylon carpet on lower door panels
- Seat back side shields (2-door)
- Color-keyed deluxe seat belts



Shown left is the standard Marquis Brougham interior with the optional power Flight Bench seat in dark red cloth. The optional power Flight Bench seat is also available with left and right-hand recliners. Shown above are just three of the many convenience features for Marquis Brougham. From the top down you see the standard sail-mounted left-hand remote control rear view mirror, the optional Twin Comfort Lounge seat with optional left and right-hand recliners, and Date/Elapsed Time Digital clock option. Other options to add driving pleasure to your Marquis Brougham will be found on pages 14 and 15, with many illustrated.

Marquis Brougham Flight Bench seat interior

## 1979 MERCURY MARQUIS. AFFORDABLE LUXURY IN ALL-NEW STYLING.

From computerization and modal analysis to sophisticated electronics, applicable modern techniques were applied in our determination to bring you the most scientifically designed Marquis in history. The end result: Mercury Marquis for '79, a new automobile, sized and built with the help of modern science. You see below one of the two most affordable models, the Mercury Marquis 4-door sedan in a dark pine exterior with

optional vinyl roof in dark green. Note the new refinements in Marquis' vertical bar theme front grille, with bright grille surround molding, rectangular dual headlamps and fender-mounted parking lights. They add a distinctive touch of elegance to every Mercury Marquis, whether two-door or four-door. And each brings you the wealth of standard features that we believe help make the new Mercury Marquis a car of exceptional value.

### Included in the long list of standard Mercury Marquis features:

- 5.0 litre (302 CID) engine
- Select-Shift automatic transmission
- Power steering
- Power brakes—front disc/rear drum
- BSW steel-belted radial tires
- Deluxe sound package
- Concealed electric windshield wipers
- Windshield washer jets in wiper arms
- Coolant recovery system
- Flight Bench seat
- Seat cushion side shields
- Dual pod instrument cluster
- Steering column-mounted controls for washer/wiper, hi-low headlamp beam, horn

- Nylon cut-pile carpeting
- Color-keyed 4-spoke steering wheel
- Woodtone appliques on instrument panel
- Glove box light
- Bright LH outside mirror
- Bright moldings
- Horizontal wraparound taillamps w/integral side marker lights
- Vertical backup lamps
- Single stroke parking brake
- 36 amp. battery
- Day/night mirror

Pictured below is the Marquis vinyl interior. The Flight Bench seat with center armrest is in camel color vinyl. Other upholstery color choices are dark red, medium Wedgewood blue, pine green and cordovan for either cloth or vinyl, with dove grey also available in vinyl.

The AM/FM stereo radio shown below is one of six entertainment center options available. A list of all radio and radio tape combination, including the 40-channel CB, also shown below, will be found on pages 14 and 15, along with other available comfort, convenience and performance options.



Wiper-mounted windshield washer jets

One of the many standard convenience features on the affordable new Mercury Marquis is pictured above: windshield wipers with washer jets mounted on the wipers.



Mercury Marquis 4-door sedan

NOTE: Some items are optional. See notable standard features, measurements, and color code reference listed throughout this catalog.



Optional AM/FM Stereo radio



Optional 40-channel CB Radio

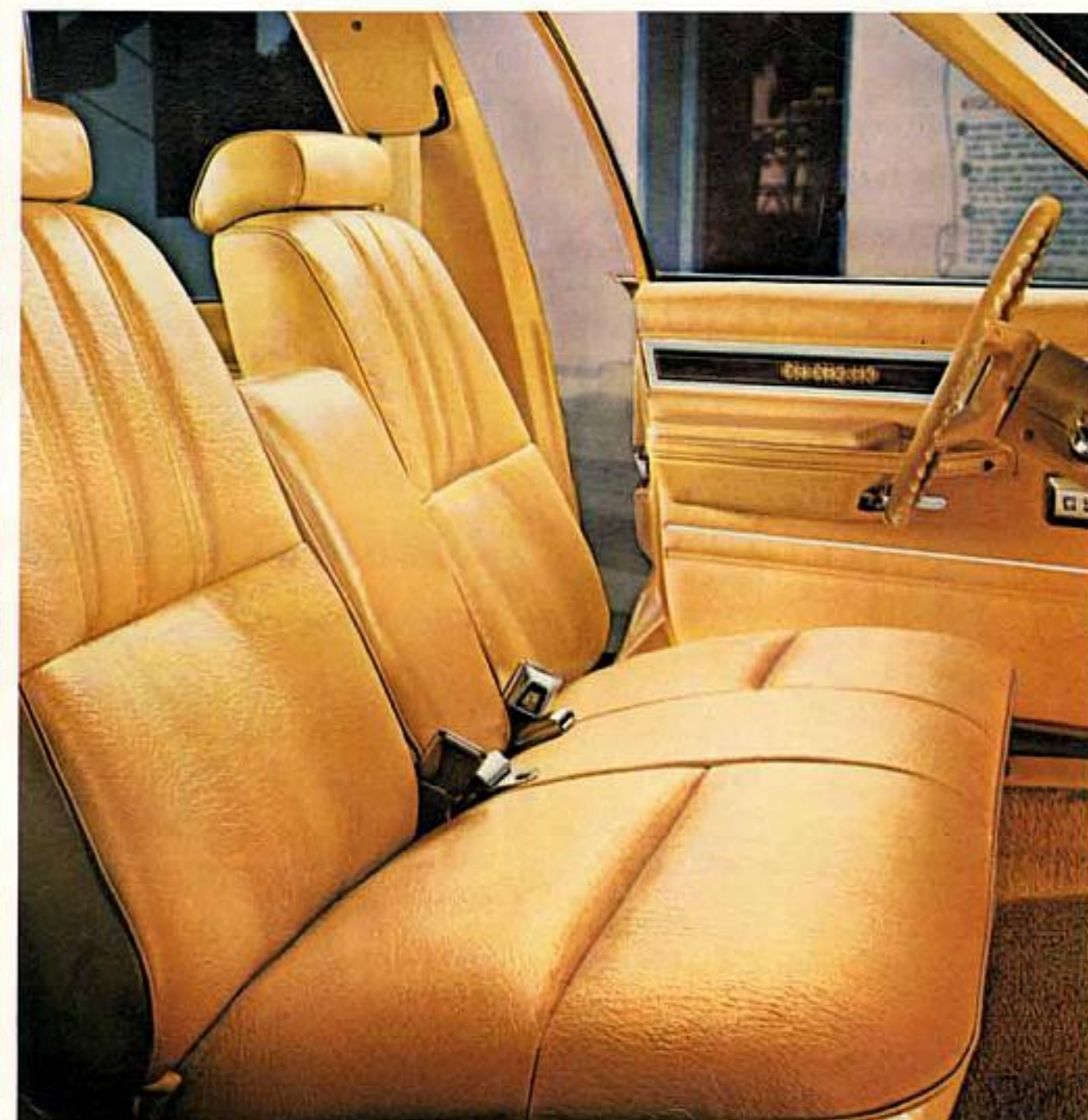

Optional Marquis interior in camel Ruffino vinyl

Mercury Marquis Colony Park Station Wagon



NOTE: Some items are optional. See notable standard features, measurements, and color code reference listed throughout this catalog.

Colony Park Grand Marquis Decor Option Twin Comfort Lounge Seat

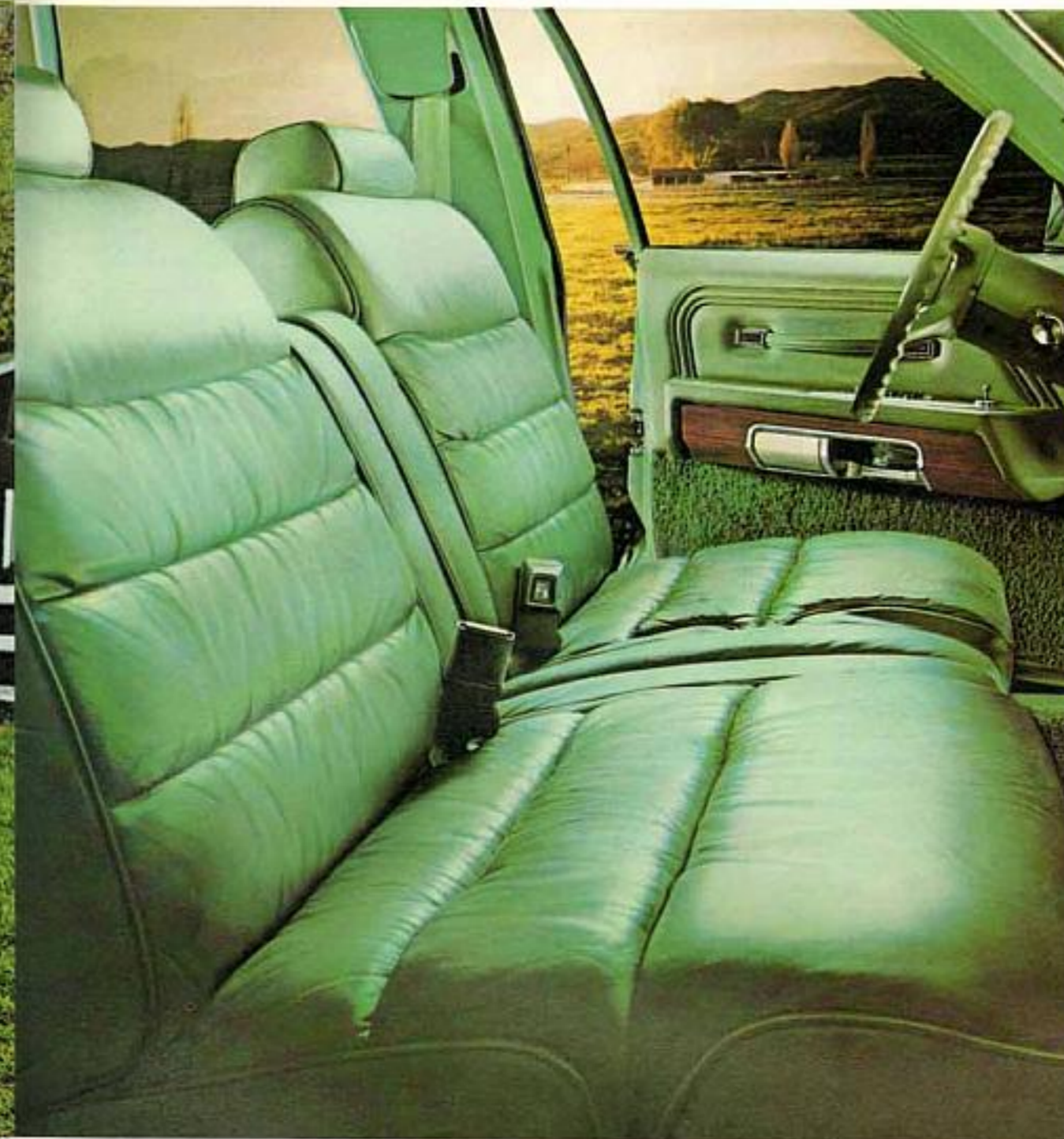

## FOR 1979: TWO NEW STATION WAGONS IN THE MERCURY TRADITION.

As in the past, Mercury Marquis offers a two-way choice in station wagons. There's the Mercury Marquis Station Wagon, and the ultimate in Mercury Wagon luxury, the Marquis Colony Park, shown above in white, with full-length bodyside and tailgate in rosewood woodtone appliques.

Each is a beautiful wagon in its own right. Each is spacious. According to the EPA Volume Index the 1979 Marquis wagons have a total interior volume of 166 cubic feet, two cubic feet more than the spacious 1978

models. And, with a 48.2" width between wheel housings, the new '79 retains the capability of accommodating four foot by eight foot sheets of plywood.

### Marquis Station Wagon standard features different from pertinent standard features for Marquis sedans on page 10:

- Lockable stowage compartment
- Removable load floor carpet
- Flight Bench seat in Ruffino vinyl
- 3-way door/gate
- Power door/gate window

- Heavy-duty frame
- Rear bumper step pad
- Conventional spare tire/wheel

### Colony Park standard features in addition to Marquis Wagon standard features:

- Full-length bodyside and tailgate rosewood woodtone appliques, matching bright and woodtone rails
- Sail-mounted LH remote control mirror
- Coach lamps
- Deluxe wheel covers
- 18 ounce Tiffany carpeting
- Tailgate activated cargo compartment light
- Analog clock
- Deluxe seat belts
- Power windows



Marquis wagon 3-way door/gate

Marquis wagon interiors are designed to provide luxurious surroundings as well as comfort. Shown above is the Colony Park Grand Marquis Decor Option featuring Twin Comfort Lounge seats in pine green leather-and-vinyl. This elegant seating is also available in dark red, camel, cordovan and medium Wedgewood blue.

The 3-way door/gate pictured above is one of many Marquis Wagon convenience features. Left-to-right, you see it opening out with the power window down; opening out with the power window up; and with the gate down and level with the load floor for extra platform length.



Optional wagon center facing seats

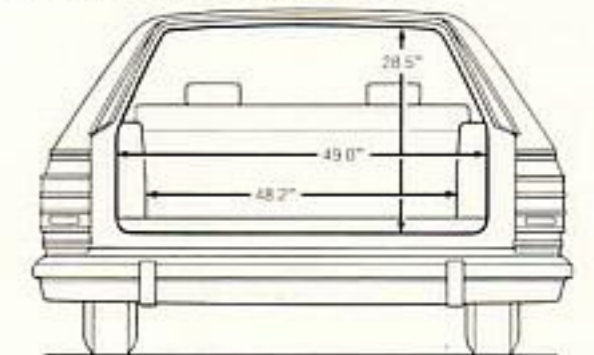

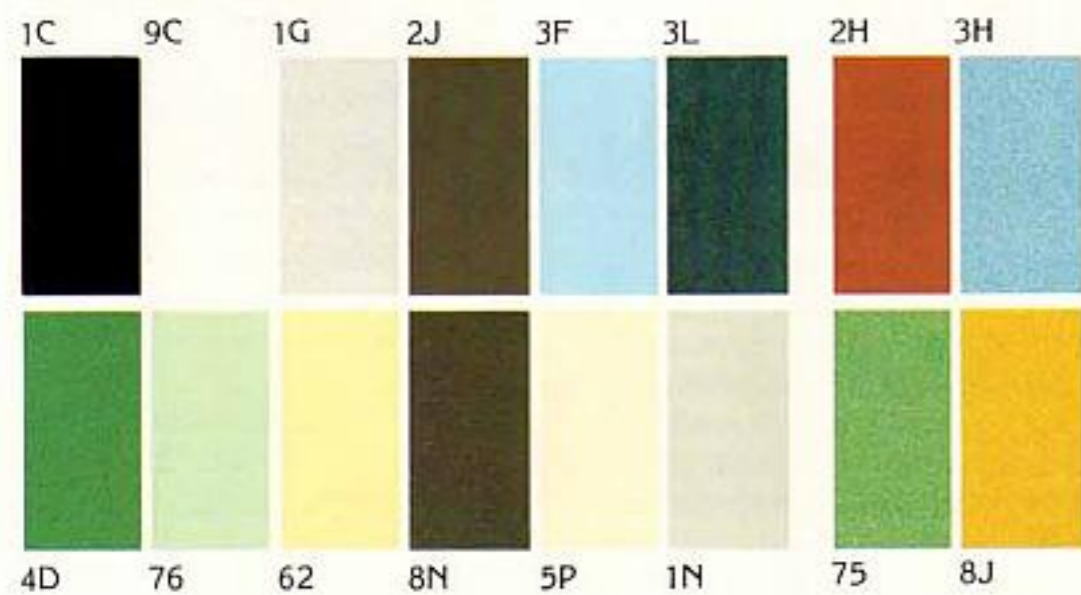
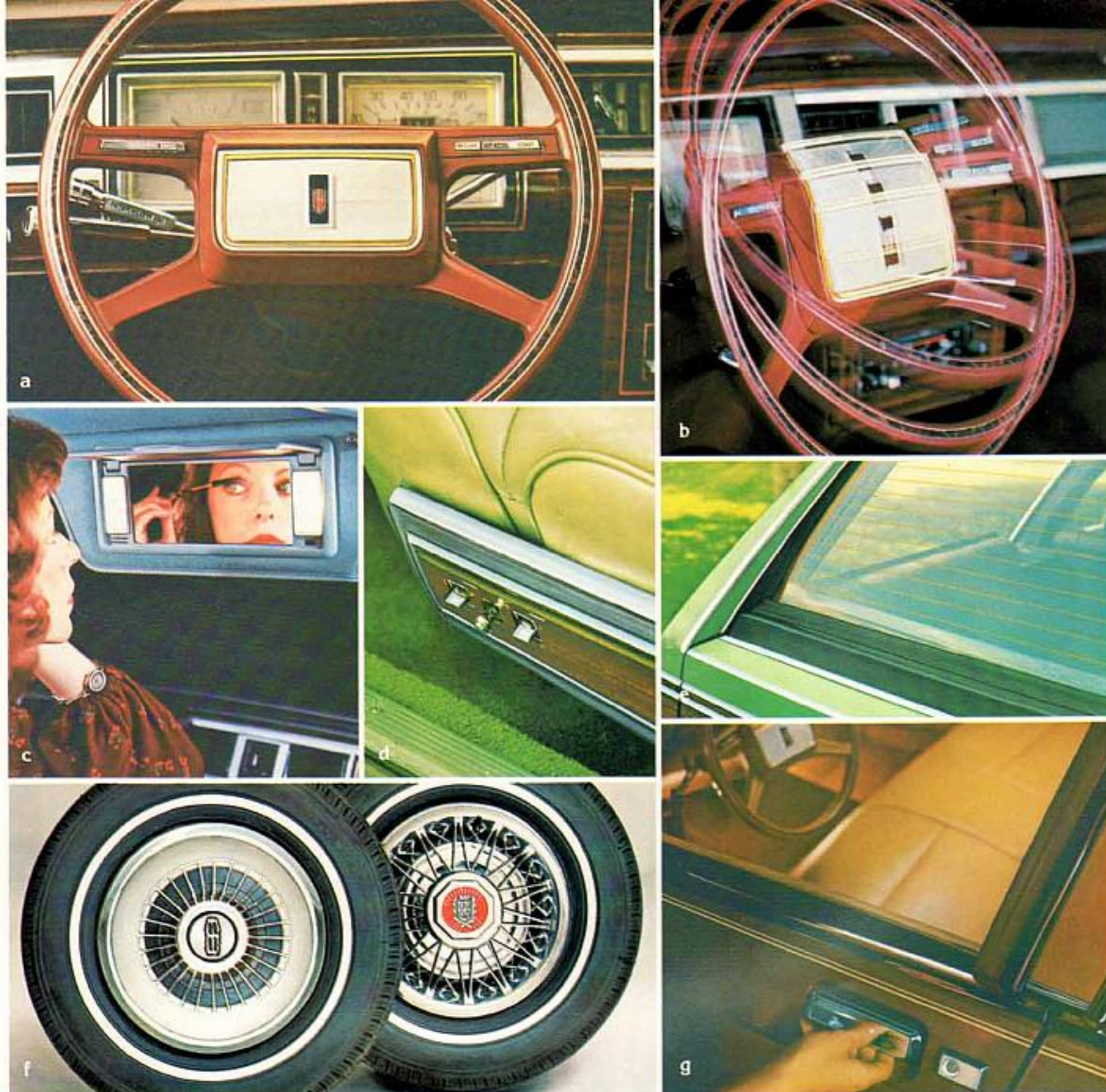

### MARQUIS EXTERIOR COLORS.

- Standard Colors**
- 1C Black
  - 9C White
  - 1G Silver Met.
  - 2J Dark Maroon
  - 3F Lt. Med. Blue
  - 3L Dark Blue Met.
  - 4D Dark Pine Met.
  - 76 Lt. Med. Pine
  - 62 Antique Cream
  - 8N Dark Cordovan Met.
  - 5P Pastel Chamois
  - 1N Dove Grey
  - Optional Glamour Paints**
  - 2H Med. Red Met.
  - 3H Med. Blue Met.
  - 75 Med. Pine Met.
  - 8J Med. Tan Met.

Optional Tu-Tone accent paint treatment similar to that shown on pg. 6 is also available. See your dealer for details.

Colors shown here are a printed representation. For accurate color selection, see your Lincoln-Mercury dealer.

## OPTIONS TO PERSONALIZE YOUR MARQUIS

With respect to extra-cost optional equipment, make certain you specify the type of equipment you desire on your vehicle when ordering it from your dealer. Before taking delivery of the vehicle, we suggest that you verify that it includes the optional equipment you ordered or if there are changes they are acceptable to you. Some options have restricted availability or require other options as a requirement of availability. See your dealer for details.

- a. 1979 Speed Control w/new "resume" feature
- b. Tilt Steering Wheel
- c. Illuminated Passenger Side Visor Vanity Mirror
- d. Four choices in power seats, depending on seat choice
- e. Electric Rear Window Defroster
- f. (l) Luxury wheel covers, (r) wire wheel covers
- g. Illuminated Entry System for keyhole and interior lights



Consider the Ford Extended Service Plan. While you're considering options for your Mercury Marquis, give a thought to ordering Ford Motor Company's Extended Service Plan. It's available to help protect you against rising service costs. And it's backed by Ford Motor Company and honored by participating Lincoln-Mercury dealers nationwide. Ask your dealer for details.

MARQUIS OPTIONS	AVAILABILITY				
	Marquis	Marquis Brougham	Grand Marquis	Marquis Wagon	Colony Park Wagon
<b>PERFORMANCE RELATED</b>					
5.8 litre (351 CID) 2V Engine	X	X	X	X	X
71 amp. Heavy-duty Battery	X	X	X	X	X
Heavy-duty Suspension	X	X	X	X	X
Trailer-towing Package	X	X	X	X	X
Extended Service Plan	X	X	X	X	X
<b>COMFORT &amp; CONVENIENCE</b>					
Air Conditioning, Automatic or Manual Control	X	X	X	X	X
Clock, Analog	X	Std.	Std.	X	Std.
Clock, Electronic Date/Elapsed Time Digital	X	X	X	X	X
Convenience Group (1)	X	X	X	X	X
Cornering Lamps	X	X	X	X	X
Defroster, Electric Rear Window	X	X	X	X	X
Illuminated Entry System (2)	X	X	X	X	X
Interval Windshield Wipers	X	X	X	X	X
Manual Load Levelers	X	X	X	X	X
Mirror, LH Remote Control	X	Std.	Std.	X	Std.
Mirror, Illuminated Visor Vanity	X	X	X	X	X
Paint, Glamour	X	X	X	X	X
Paint, Tu-Tone	X	X	X	X	NA
Power Antenna	X	X	X	X	X
Power Seat, Flight Bench	X	X	NA	X	X
Power Seat, Reclining Flight Bench	X	X	NA	X	X
Power Seat, 6-way Driver Side (3)	NA	X	X	NA	X
Power Seat, 6-way both sides (3)	NA	X	X	NA	X
Seat, Reclining Twin Comfort	NA	X	X	NA	X
Power Side Window	X	Std.	Std.	X	Std.
Radio, AM	X	X	X	X	X
Radio, AM/FM Stereo	X	X	X	X	X
Radio, AM/FM w/Tape	X	X	X	X	X
Radio, AM/FM Stereo w/Cassette	X	X	X	X	X
Radio, AM/FM Stereo Search w/Quad-8 Tape	X	X	X	X	X
Radio, Citizens Band (4)	X	X	X	X	X
Seats, Removable Rear Dual Facing	NA	NA	NA	X	X
Speed Control (5)	X	X	X	X	X
Steering Wheel, Tilt	X	X	X	X	X
Tinted Glass	X	X	Std.	X	X
Visibility Light Group (6)	X	X	X	X	X
<b>APPEARANCE &amp; PROTECTION</b>					
Appearance Protection Group (7)	X	X	X	X	X
Grand Marquis Decor Option (8)					X
Lock Convenience Group	X	X	X	X	X
Molding, Protective Bodyside (Narrow)	X	X	X	X	X
Paint Stripes, Bodyside	X	X	Std.	X	NA
Protection, Lower Bodyside	X	X	X	X	X
Roof, Full vinyl (4-door models)	X	Std.	Std.	NA	NA
Roof, Landau vinyl (2-door models)	X	Std.	Std.	NA	NA
Trim, Flight Bench vinyl	X	X	NA	Std.	Std.
Wheel Covers, Luxury	X	X	X	X	X
Wheel Covers, Wire	X	X	X	X	X

X—Available Std.—Standard NA—Not Available  
The above is only a partial list of options. See your dealer for a complete list.

- (1) Interval windshield wipers; visor vanity mirror (standard on Grand Marquis); electric decklid lock (tailgate lock on wagons); trip odometer and warning light cluster (standard on Grand Marquis). All mirrors are sail-type.
- (2) Includes activation of a ring of light around key hole and interior lights by pulling the outside door handle.
- (3) Only with Twin Comfort Lounge seats.
- (4) Requires a regular radio option.
- (5) Includes new "resume speed" feature and luxury steering wheel.
- (6) Includes engine compartment light; dome dual beam map light (std. on Grand Marquis); dual instrument panel courtesy lamps and trunk/cargo lamps (both std. on Grand Marquis, Marquis Brougham and Colony Park); and headlamp-on warning buzzer.
- (7) Includes door edge guards, front and rear floor mats and license plate frames (rear only unless front plate is ordered).
- (8) Includes Twin Comfort Lounge Seats (see page 13), luxury steering wheel, tinted glass, dome/dual beam map light, visor vanity mirror, seat back strips and map pockets, seat belt warning chimes.

### MARQUIS ENGINE AVAILABILITY

Engine	Mercury Marquis	Marquis Brougham	Grand Marquis	Marquis Wagons
5.0 Litre (302 CID)	Std.	Std.	Std.	Std.
5.8 Litre (351 CID)*	Opt.	Opt.	Opt.	Opt.

\*Includes 45 amp. battery and is equipped with Electronic Engine Control. Mandatory on station wagons in California. All vehicles are equipped with Select-Shift Automatic Transmission.



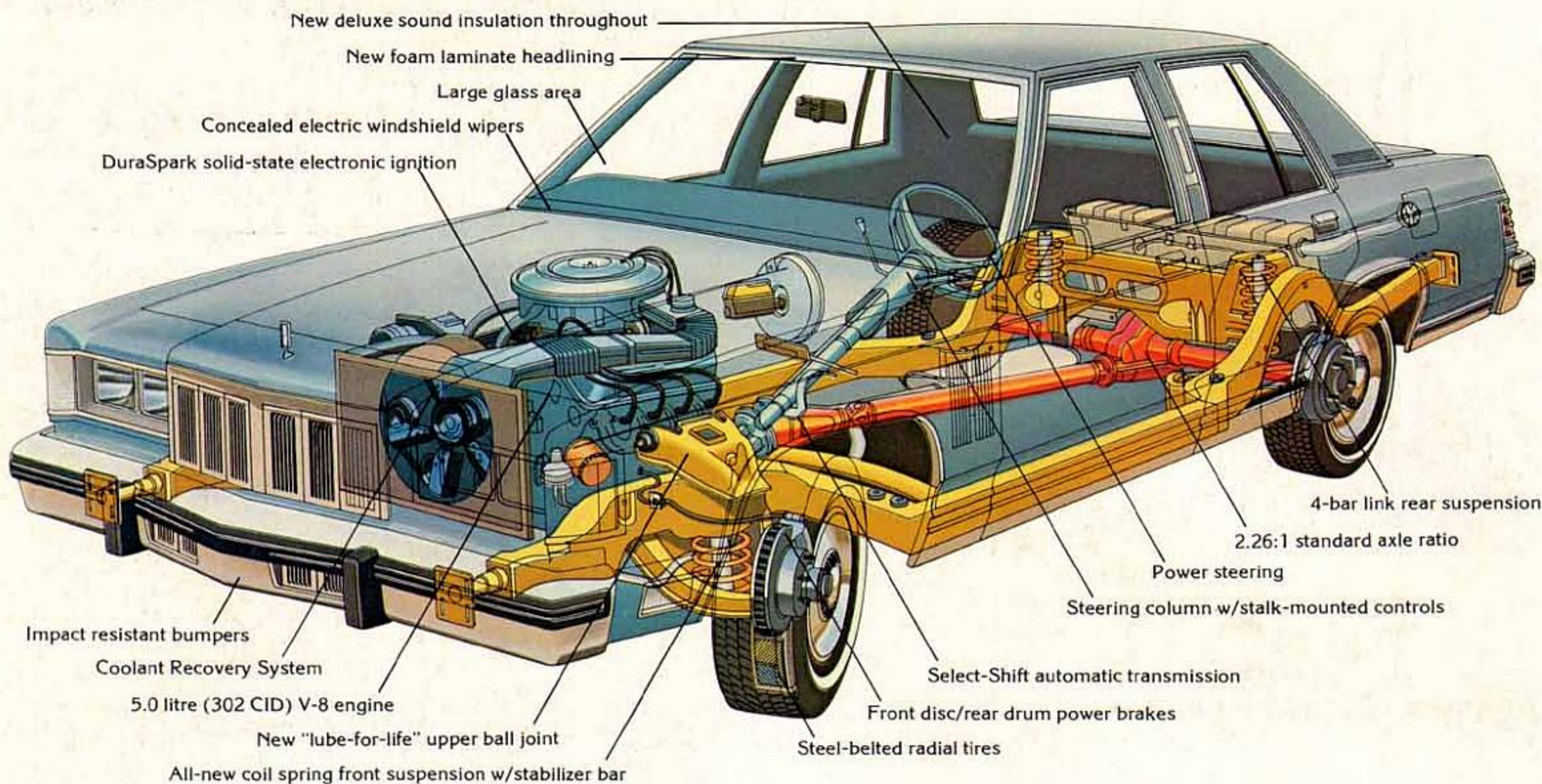

## DIAGRAMMATIC STUDY OF MERCURY MARQUIS ENGINEERING.

**Marquis Engines:** Standard engine for all-new Marquis models is the 5.0 litre (302 CID) V-8. An optional 5.8 litre (351 CID) V-8 is available. (Standard transmission is the Select-Shift automatic.)

**Marquis Suspension:** Marquis' front suspension with stabilizer bar has a new low friction design upper ball joint requiring no lubrication. Rear suspension is a 4-bar link design incorporating coil springs.

**Marquis Brakes:** For 1979 a new pin slider front disc brake system was designed for Marquis. This system offers improved pedal sensitivity.



Mercury Grand Marquis 2-door sedan



Mercury Grand Marquis 4-door sedan



Mercury Marquis Brougham 2-door sedan



Mercury Marquis Brougham 4-door sedan



Mercury Marquis 2-door sedan



Mercury Marquis 4-door sedan



Mercury Marquis Colony Park Wagon



Mercury Marquis Wagon



**TESTED TOUGH**

Motorcraft battery, shock absorbers, ignition parts and Long Life Oil Filter. For continued top performance be sure to specify genuine Motorcraft parts whenever replacement is necessary.

**Quality Replacement Parts from Ford.** Your new Mercury Marquis comes equipped with factory engineered and approved parts including a dependable

**MERCURY MARQUIS**

LINCOLN-MERCURY DIVISION



Lincoln-Mercury Division reserves the right to discontinue or change specifications or designs at any time, without incurring any obligations. Some features shown or described previously are optional equipment items which are available at extra charge. Some options are required in combination with other options.