

THERE IS A SPECIAL FEEL IN AN OLDSMOBILE



1985  
*Ninety Eight  
Regency*





It goes beyond the  
Ninety-Eight of your mind  
to the Ninety-Eight  
of your dreams.

The Ninety-Eight of your mind would be a marvel of technological sophistication.

It would have a precise road management system to elevate the luxury car to touring car capability. This system would help smooth the road with 4-wheel independent suspension, automatic electronic load leveling, rack-and-pinion steering, and front-wheel drive.

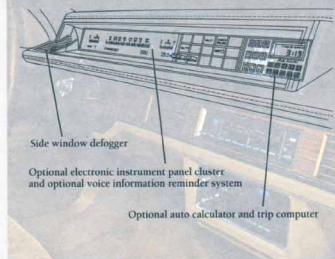
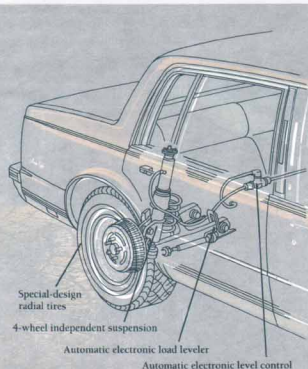

The Ninety-Eight of your mind would have an engine that would provide spirited performance with commendable economy of operation.

The Ninety-Eight of your mind would make available an array of the latest electronic technology, including such features as an electronic instrument panel,\* auto calculator with display screen, and a voice information reminder system.

The Ninety-Eight of your mind would be dedicated to uncompromising standards of quality and dependability now available through computer assisted design and manufacturing.

The Ninety-Eight of your mind is here right now, with all its high technology.

The Ninety-Eight of your dreams, however, would envision sleek new styling, elegant yet contemporary, with a new multi-coat, high-gloss enamel finish of unusual depth and durability.

The Ninety-Eight of your dreams would have sumptuous velour interiors to set off spacious accommodations for six passengers.

The Ninety-Eight of your dreams would provide an abundance of creature comforts, all the amenities to make driving a joy.

The Ninety-Eight of your dreams is here right now, with all its style, luxury and comfort.

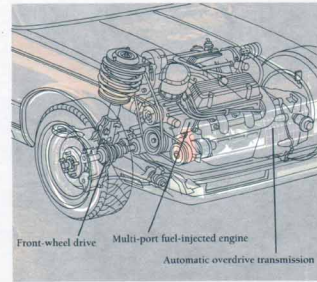

As you will see, the new 1985 Ninety-Eight Regency takes that beautiful marriage of logic and luxury in Ninety-Eights of the past and carries it to new heights of pleasure and satisfaction. \*Electronic instrument panel available after June, 1984.

THERE IS A SPECIAL FEEL  
IN AN





It goes beyond the  
Ninety-Eight of your mind  
to the Ninety-Eight  
of your dreams.

The Ninety-Eight of your mind would be a marvel of technological sophistication.

It would have a precise road management system to elevate the luxury car to touring car capability. This system would help smooth the road with 4-wheel independent suspension, automatic electronic load leveling, rack-and-pinion steering, and front-wheel drive.



The Ninety-Eight of your mind would have an engine that would provide spirited performance with commendable economy of operation.

The Ninety-Eight of your mind would make available an array of the latest electronic technology, including such features as an electronic instrument panel,\* auto calculator with display screen, and a voice information reminder system.

The Ninety-Eight of your mind would be dedicated to uncompromising standards of quality and dependability now available through computer assisted design and manufacturing.

The Ninety-Eight of your mind is here right now, with all its high technology.

The Ninety-Eight of your dreams, however, would envision sleek new styling, elegant yet contemporary, with a new multi-coat, high-gloss enamel finish of unusual depth and durability.

The Ninety-Eight of your dreams would have sumptuous velour interiors to set off spacious accommodations for six passengers.

The Ninety-Eight of your dreams would provide an abundance of creature comforts, all the amenities to make driving a joy.

The Ninety-Eight of your dreams is here right now, with all its style, luxury and comfort.



As you will see, the new 1985 Ninety-Eight Regency takes that beautiful marriage of logic and luxury in Ninety-Eights of the past and carries it to new heights of pleasure and satisfaction. \*Electronic instrument panel available after June, 1984.

THERE IS A SPECIAL FEEL  
IN AN





Dedicated to the premise that a luxury car can never be too luxurious.

Creating a truly spacious, truly luxurious interior setting for six was uppermost in the minds of Oldsmobile stylists and designers.

How well they succeeded is exemplified by the elegant Ninety-Eight Regency Brougham interior shown here. They preserved the traditional room for which Regency has been so highly regarded.

Rich velour fabrics, deep cut-pile carpeting, handsome appointments (including a tastefully embroidered Regency crest), set the stage for the delights within.

Now the divided full-foam seats provide the added comfort of lateral and lumbar supports, with 6-way power control for the driver's seat. Among many other equally nice touches.

Supple Sierra grain leather also is available for the seating areas, as well as a "memory seat" which can be pre-set for two drivers.

The lap of luxury was never more appealing than in a 1985 Ninety-Eight Regency.

THERE IS A SPECIAL FEEL  
IN AN OLDSMOBILE!

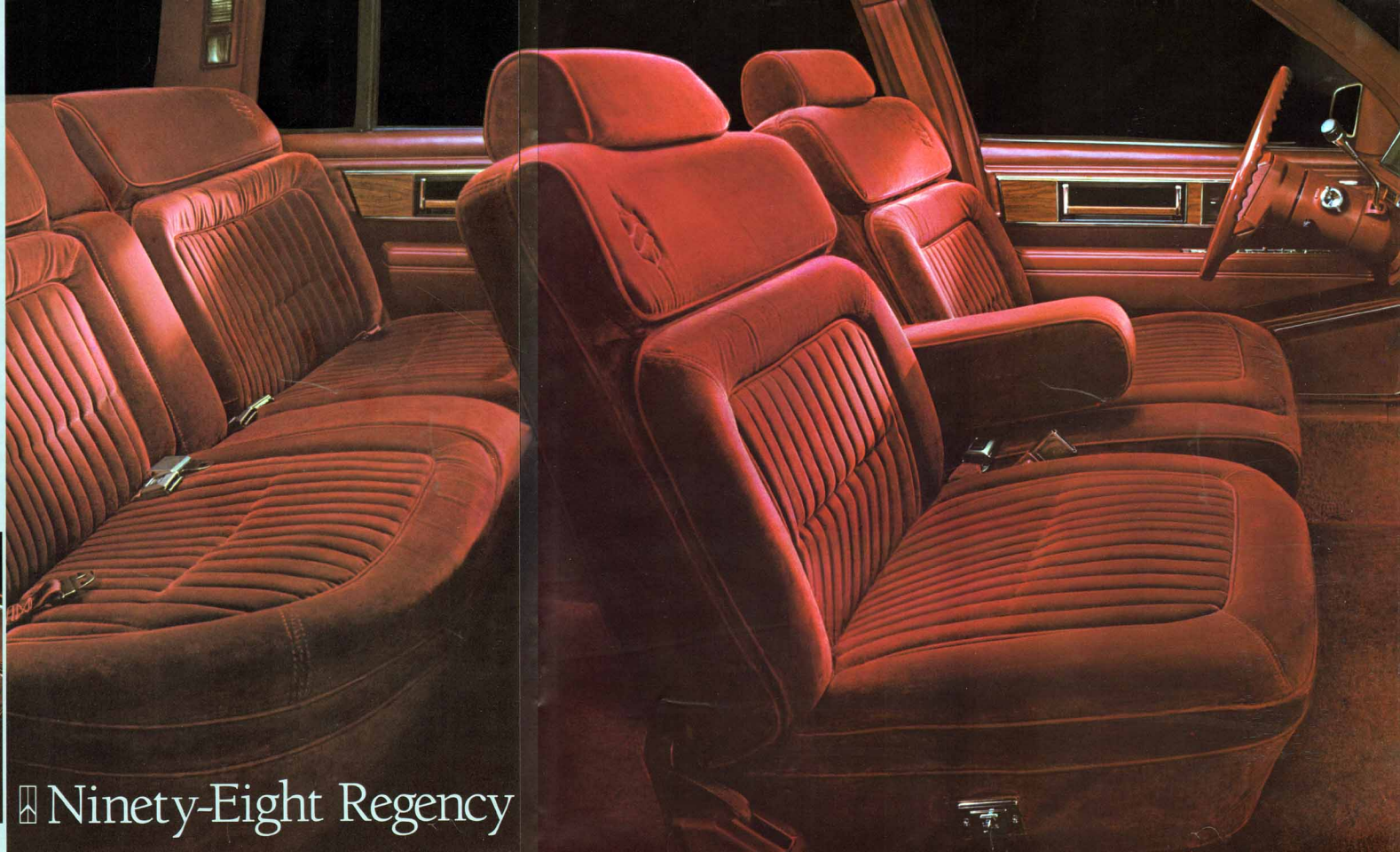
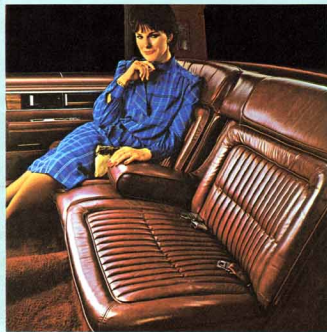

 Ninety-Eight Regency

Presenting a new dimension  
in Oldsmobile luxury.

Over the years, Oldsmobile has introduced many magnificent Ninety-Eight models. Now the 1985 Ninety-Eight Regency takes its place to set new standards for how a luxury car should look, how it should act, and the luxury it should offer. How was it achieved?

By retaining the interior space so important to Ninety-Eight owners—except to make it more comfortable and luxurious.

By re-engineering the ride for differences in road and driving conditions.

By introducing a lustrous new multi-coat, high-gloss enamel finish.

By providing a new 3.8-liter multi-port fuel-injected V6 and an available 4.3-liter diesel V6.

By paying scrupulous attention to detail, the meticulous fit and finish of body parts.

By putting them all together in a sleek and utterly luxurious new automobile.

And quality? It's outstanding—built-in at two of the most modern automobile assembly plants in the world.

THERE IS A SPECIAL FEEL  
IN AN OLDSMOBILE!



▣ Ninety-Eight Regency Brougham Sedan

Precise road management  
engineered into luxury automobiles.

Oldsmobile's ultimate luxury coupe brings with it the ultimate in luxury car ride: Oldsmobile's precise road management system.

It's the way all 1985 Ninety-Eights are designed to deliver a smooth, comfortable ride under even less than ideal riding conditions. Back roads. Heavy loads.

Each wheel, for example, has its own independent suspension to better dissipate bumps and shock.

An electronic load leveler automatically keeps your Ninety-Eight riding on an even keel, regardless of passenger or trunk load.

The engine and front suspension have been isolated from the body, so you ride in quiet splendor.

Of course, front-wheel drive and rack-and-pinion steering add to the sure tracking.

A smooth 3.8-liter, multi-port, fuel-injected V6 is standard on Brougham models; 4.3-liter diesel V6 available on all Ninety-Eight models.

So enjoy the luxury ride. Your Ninety-Eight Regency will manage the road.

THERE IS A SPECIAL FEEL  
IN AN OLDSMOBILE!



⊞ Ninety-Eight Regency Brougham Coupe

The "thinking man's" luxury car. How it got the reputation.

Even persons of means and substance do not approach the purchase of a luxury automobile with a diffident attitude on the one hand and an open checkbook on the other.

Having worked hard for what they've gotten, they carefully evaluate the choices before they commit themselves.

They would determine, for example, that Ninety-Eight Regency incorporates the latest advances in technology, while providing an abundance of standard equipment.

They would ascertain that the purchase price of a Regency was surprisingly moderate for a car offering so many amenities.

They would learn that economy of operation has been improved by Regency's new 3.0-liter V6 and available multi-port fuel-injected 3.8-liter V6.

And, finally, they would be pleased to find that Ninety-Eight Regency resale value has traditionally worked to the advantage of the Regency owner.

We rest our case.

THERE IS A SPECIAL FEEL  
IN AN OLDSMOBILE!

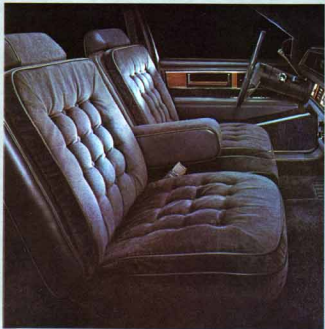

 Ninety-Eight Regency Sedan and Coupe

There is a special feel with these Ninety-Eight Regency features and options.



A "memory seat" allows two drivers to pre-select desired comfort positions, then by pushing a button, commit them to computer memory for future seating. A real convenience for multiple-driver families. Available.

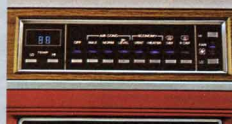

**New electronic auto calculator/trip computer.** In addition to trip functions, it works as a math calculator. Available.

**New electronic comfort control air conditioner** with digital temperature display. Available. (Four-Season air conditioner, standard). **Electronically tuned radio** with automatic loudness compensation and dynamic noise reduction. Standard. May be deleted for credit.



**Dual rear seat reading lamps.** These convenient single high-intensity lamps provide full illumination for back seat reading, while not disturbing driver. Standard on Brougham models.



**Luxurious leather seating.** Discover the special feel of luxury with genuine leather in the seating areas. Available. Seats also feature the added comfort of lumbar and lateral supports.

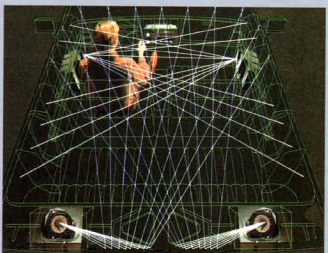

**Electronic day/night mirror.** Automatically changes from "day" to "night" position. When glare ceases, mirror returns to day position. Available.



**Electronic instrument panel cluster.\*** May be ordered with optional 19-function auto calculator and voice information reminder system.



**Full armrest controls include:** Standard power windows, six-way power seat (driver's side), optional "memory seat" and electric outside left/right mirrors.



**Power side window defogger.** Helps provide a clear view of outside rear-view mirrors. Standard.

**Delco/GM Bose music system.** It's the finest auto sound system you can order. This system was designed specifically for the acoustics of the Ninety-Eight Regency. Truly luxurious listening.

\*Available after June, 1984.

High technology runs deep in a Ninety-Eight Regency.

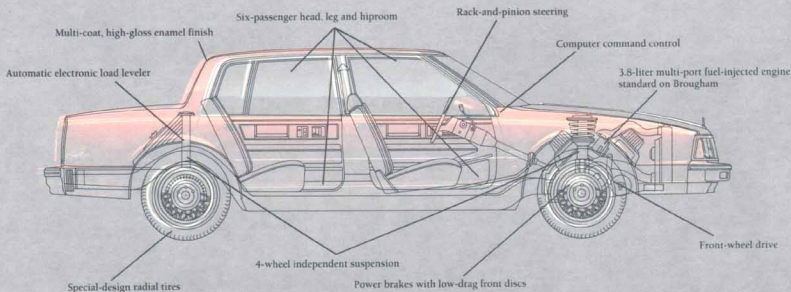

**NINETY-EIGHT REGENCY STANDARD EQUIPMENT Chassis and Body:**

- 11-Valve Inverse-Mounted Engine with Four-Wheel Drive
- Computer Command Control
- Unit Body Construction
- Four-Wheel Independent Suspension with MacPherson Front Struts
- Automatic Leveling System
- 17-Point Anti-Corrosion Treatment
- Power Front Locking Disc Brakes
- Power Back-and-Pinion Steering
- High-Energy Ignition System
- Maintenance-Free Battery
- DeLuxe Dual Remote Control Outside Mirrors
- Complex Spare Tire
- Lower Body Side Belt Recessed Road Rump Rocker Panel and Wheel-Opening Moldings
- Body Side Moldings with Inserts (Regency Brougham models)
- Headlamps with Tinted Halogen High Beams
- Front Fender Cornering Lamps (Regency Brougham models)
- Pillar Mounted Stop Lamps
- Padded Vinyl-Landau Rooftop Covering (Regency Brougham Coupe models)
- Easy-Roll High-Pressure Window-Stripes
- All-Season Tires
- Deluxe Wheel Discs (Regency models)
- Stomatized Wire Wheel Discs with Locks (Regency Brougham models)
- Deluxe Trunk Trim with Space-Tie Garage Interier
- Four-Season Air Conditioner
- Armrests, Front and Rear Seat, Center
- Wall-to-Wall Carpeting with Carpeted Lower Door Panels
- Cigarette Lighters, Instrument Panel and Rear-Seat
- Convenience Package of Lamps, Vision Vanity Mirror and Chrome Inserts
- Power Door Locks
- Door-Pull Handles
- Hood Lock Release
- Interier Operated Restraint in Panel Simulated Regency Walnut Grain Trim
- Trip Odometer
- Heator Panel Reading Lamp
- Lamp Switches at all Doors
- Remote Control Outside Mirrors, Driver and Passenger Side
- AM-FM Stereo Radio with Digital Quartz Clock
- Two Rear Speakers and Front, Main Antenna (May be deleted for credit)
- Full-Exten Seat Construction
- Divided Front Seat with Dual Controls
- Driver Side 6-Way Power, Passenger Side Manual
- Deluxe Seat Belts, Color-Coordinated to Individual Interiors

**NINETY-EIGHT REGENCY POWER TEAMS**

- Standard Engine\* (Regency models)
- Low/Type 3.0 V6
- Cylinder 6
- Electrically Controlled Fuel Injection
- Standard Engine\* (Regency models)
- Low/Type 3.0 V6
- Cylinder 6
- Electrically Controlled Fuel Injection

**Litre Type**

- Available Engine\*
- Low/Type 4.3 V6 Diesel

**DOHNSON:**

- Overall length (in.) 196.1
- Wheelbase (in.) 111.6
- Engine Cap. (cu. ft.) 13.1
- Standard Transmission
- 4-Speed Automatic Overdrive with Torque Converter Clutch
- Headroom, Front (in.) 58.3-58.4
- Rear (in.) 58.1-58.4

**Engross:**

- Front (in.) 51.4-52.4
- Rear (in.) 49.1-49.8
- Compartment Volume (cu. ft.) 36.9-38.9
- Front (in.) 57.6-58.6
- Rear (in.) 57.6-58.6
- Fuel Tank (gals.) 18.0

**Comp/Seals:**

- Front (in.) 41.4-42.4
- Rear (in.) 40.1-40.8

- Electronic Instrument Panel Cluster (Avail. after June, 1984)
- Lock Lid Luggage Carrier
- Automatic Cruise Control with Resume and Acceleration Features
- Tilt-Away Steering Wheel (Std. on Brougham Sedan)
- Tilt-and-Telescope Steering Wheel
- Standardized Wire Wheel Discs with Locks (Std. on Regency Brougham)
- Pulse Wiper System
- Combination Door and Dual Lens Reading Lamp
- Body Side Two-Tone Paint Scheme
- High-Capacity Battery
- Electric Sliding Glass Antenna (Headliner is etched with this option)
- Puncture-Sealing Tires
- Covering Lamps (Std. on Brougham)
- Electric Luggage Antenna (Headliner is etched with this option)
- Instrument Panel Gas Cluster
- Aluminum Bezel Wheel (Std. avail. until April, 1984)
- Bumper Guards, Rear
- Exterior Lamp Monitors, Front and Rear
- Special Chrome Metallic Points on Light Blue, Dark Metallic, Champagne
- Reversible Carpet Endpapers
- High-Capacity Engine Cooling System (Not avail. on V6 models)
- Custom Leather Dress in seating areas, Maple Red, or Medium Beige (Regency), Medium Green, and Maple Red (Regency Brougham)
- 17-Point Electrical Wiring Harness

**STANDARD EQUIPMENT BY MODEL:**

- Ninety-Eight Regency Brougham
  - Engine, 3.8-liter V6, with Multi-Port Fuel Injection
  - 4-Speed Automatic, Overdrive Transmission with Torque Converter Clutch (features)
  - Specific Model Identification
  - Five-Point Vehicle Standard Trims
  - Standardized Wire Wheel Discs with Locks
  - Front Fender Cornering Lamps
  - Sail Panel Reading Lamps
  - Body Side Moldings
  - Electrically Operated Outside Rearview Mirrors, Driver and Passenger Side
  - Four-Season Air Conditioner
  - Illuminated Visitor Vanity Mirror, Passenger Side
  - Body Side Accent Stripes
  - Engine Block Heater
  - Deluxe Engine Block and Fuel-Line Heater
  - Automatic Inside Day-Night Mirrors
  - Form Door and Handling Package
  - Fuel-Fly Door Lock with Electric Memory Release
  - Voice Information Reminder System
  - 17-Point Calculator with Digital Read-out
- Ninety-Eight Regency
  - Engine, 3.0-liter V6, 2-Valve
  - 4-Speed Automatic Overdrive Transmission with Torque Converter Clutch (features)
  - Five-Point Vehicle Standard Trims
  - P205/75R14 Steel-Belted Radial-Ply White-Stripe All-Season Tires
  - Bright Deluxe Wheel Discs

**AVAILABLE EQUIPMENT:**

- 1 6-Way Power Seat Adjuster - Passenger Side
- 2 6-Way Power Seat Adjuster - Driver Side - with 2-Position Memory Release
- 3 Retracting Seat Back - Passenger Side Manual, or Power
- 4 Power Trunk Lid Lock Release
- 5 Auxiliary Floor Mats with Carpet Inserts, Front and Rear
- 6 Luggage Compartment Floor Mat

\*See EPA mileage estimates in accompanying Fuel Economy Estimate Engine Supplement Sheet.

Get 'em together... Buckle up!



There is a special feel with these Ninety-Eight Regency features and options.

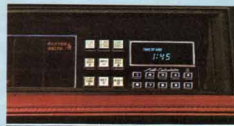

**New electronic auto calculator/trip computer.** In addition to trip functions, it works as a math calculator. Available.

**New electronic comfort control** air conditioner with digital temperature display. Available. (Four-Season air conditioner, standard). **Electronically tuned radio** with automatic loudness compensation and dynamic noise reduction. Standard. May be deleted for credit.



**Dual rear seat reading lamps.** These convenient single high-intensity lamps provide full illumination for back seat reading, while not disturbing driver. Standard on Brougham models.



**A "memory seat"** Allows two drivers to pre-select desired comfort positions, then by pushing a button, commit them to computer memory for future seating. A real convenience for multiple-driver families. Available.



**Luxurious leather seating.** Discover the special feel of luxury with genuine leather in the seating areas. Available. Seats also feature the added comfort of lumbar and lateral supports.

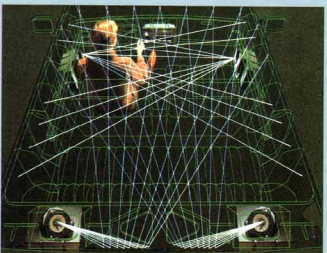

**Electronic day/night mirror.** Automatically changes from "day" to "night" position. When glare ceases, mirror returns to day position. Available.



**Electronic instrument panel cluster\*** May be ordered with optional 19-function auto calculator and voice information reminder system.



**Full armrest controls** include: Standard Power Front Windows, six-way power seat (driver's side), optional "memory seat," and electric outside left/right mirrors.



**Power side window defogger.** Helps provide a clear view of outside rearview mirrors. Standard.

**Delco/GM Bose music system.** It's the finest auto sound system you can order. This system was designed specifically for the acoustics of the Ninety-Eight Regency. Truly luxurious listening.

\*Available after June, 1984.



**NINETY-EIGHT REGENCY STANDARD EQUIPMENT**

**Chassis and Body:**  
 ■ Transverse-Mounted Engine with Front-Wheel Drive  
 ■ Computer Command Control  
 ■ Unit Body Construction  
 ■ Four-Wheel Independent Suspension with MacPherson Front Struts ■ Automatic

Leveling System ■ Extensive Anti-Corrosion Treatment  
 ■ Power Front Low-Drum Disc Brakes ■ Power Rack-and-Pinion Steering ■ High-Energy Ignition System  
 ■ Maintenance-Free Battery ■ Delcotron ■ Dual Remote Control Outside Mirrors ■ Compact Spare Tire ■ Lower Body Side Belt Reveal, Roof Drip, Rocker Panel and Wheel-Opening Moldings ■ Body Side Moldings with Inserts (Regency Brougham models) ■ Headlamps with Tungsten Halogen High Beams ■ Front Fender Cornering Lamps (Regency Brougham models) ■ Pillar Mounted Over Lamps ■ Padded Vinyl Landau Roofcap Covering (Regency/Regency Coupe models) ■ Easy-Roll High-Pressure White-Stripe All-Season Tires ■ Deluxe Wheel Discs (Regency models) ■ Simulated Wire Wheel Discs with Locks (Regency Brougham models) ■ Deluxe Trunk Trim with Spare Tire Cover

**Interior:**

■ Four-Season Air Conditioner ■ Armrests, Front and Rear Seat, Center ■ Wall-to-Wall Cur-Pile Carpeting with Carpeted Lower Door Panels ■ Cigar Lighters, Instrument Panel and Rear Seat ■ Convenience Package of Lamps, Visor Vanity Mirror and Chime Tones ■ Power Door Locks ■ Door-Pull Handles ■ Hood Lock Release, Inter-Operated Instrument Panel Simulated Regency Walnut Grain Trim ■ Trip Odometer ■ Header Panel Reading Lamp ■ Lamp Switches at All Doors ■ Remote Control Outside Mirrors, Driver and Passenger Side ■ AM-FM Stereo Radio with Digital Quartz Clock, Two Rear Speakers and Fixed Mast Antenna (May be deleted for credit) ■ Full-Form Seat Construction ■ Divided Front Seat with Dual Controls—Driver Side 6-Way, Power, Passenger Side Manual ■ Deluxe Seat Belts, Color-Coordinated to Individual Interiors

**NINETY-EIGHT REGENCY POWER TEAMS**

**Standard Engine\*** (Regency models)  
 Liter/Type 3.0 V6 Carburetion Electronically-Controlled Fuel Injection  
**Standard Transmission**  
 4-Speed Automatic Overdrive with Torque Converter Clutch

**3.8 V6 Fuel Injection**  
 Available Engine\*  
 Liter/Type 4.3 V6 Diesel

**Multi-Port Fuel Injection**  
 Multi-Port Fuel Injection

**4-Speed Automatic Overdrive**  
 4-Speed Automatic Overdrive with Torque Converter Clutch

**Overall length (in.)** 194.4  
**Wheelbase (in.)** 110.8  
**Luggage Cap. (cu. ft.)** 15.7

**Headroom, Front (in.)** 38.3/39.3  
**Rear (in.)** 38.1/38.1

**Coupe, Front (in.)** 38.3/39.3  
**Rear (in.)** 38.1/38.1

**Legroom, Front (in.)** 42.4/42.4  
**Rear (in.)** 40.8/40.8

**Shoulder Room, Front (in.)** 38.9/38.9  
**Rear (in.)** 37.6/38.8

**Fuel tank (gals.)** 18.0

**Body Side Moldings (Std. on Brougham)**  
 ■ Door-Edge Guards  
 ■ Full Vinyl Padded Roof Covering (Sedan)  
 ■ Electric Rear Window Defogger  
 ■ Electronic Air Conditioner  
 ■ Sail Panel Reading Lamps (Std. on Brougham)  
 ■ Automatic Power Door Locks  
 ■ Front Door Locks and Interior Illumination Package  
 ■ Electrically Operated Outside Rearview Mirrors, Driver and Passenger Side  
 ■ Front Seat Liner Container  
 ■ Illuminated Visor Vanity Mirror, Passenger Side  
 ■ Body Side Accent Stripes  
 ■ Engine Block Heater  
 ■ Diesel Engine Block and Fuel-Line Heater  
 ■ Automatic Inside Day/Night Mirror  
 ■ Firm Ride and Handling Package  
 ■ Fuel Filler Door Lock with Electric Remote Release  
 ■ Voice Information Reminder System  
 ■ Auto Calculator with Digital Readout

**STANDARD EQUIPMENT BY MODEL**

**Ninety-Eight Regency Brougham:**

■ Engine, 3.8-liter V6, with Multi-Port Fuel Injection  
 ■ 4-Speed Automatic Overdrive Transmission with Torque Converter Clutch features ■ Specific Model Identification  
 ■ Five Prime Velour Standard Trims ■ Simulated Wire Wheel Discs with Locks ■ Front Fender Cornering Lamps  
 ■ Sail Panel Reading Lamps ■ Body Side Moldings  
 ■ Landau Padded Vinyl Roofcap Covering (Brougham Coupe) ■ Deluxe Steering Wheel with Tilt-Away feature  
 ■ Pulse Windshield Wiper system ■ P205/73R14 Steel-Belted Radial-Ply White-Stripe All-Season Tires

**Ninety-Eight Regency:**

■ Engine, 3.0-liter V6, 2-Barrel ■ 4-Speed Automatic Overdrive Transmission with Torque Converter Clutch features  
 ■ Five Prime Velour Standard Trims ■ P205/73R14 Steel-Belted Radial-Ply White-Stripe All-Season Tires  
 ■ Bright Deluxe Wheel Discs.

**AVAILABLE EQUIPMENT:**

□ 6-Way Power Seat Adjuster—Passenger Side  
 □ 6-Way Power Seat Adjuster—Driver Side—with 2-Position Memory Feature  
 □ Reclining Seat Back—Passenger Side Manual, or Power  
 □ Power Trunk-Lid Lock Release  
 □ Auxiliary Floor Mats with Carpet Inserts, Front and Rear  
 □ Luggage Compartment Floor Mat

□ Electronic Instrument Panel Cluster (Avail. after June, 1984)  
 □ Deck Lid Luggage Carrier  
 □ Automatic Cruise Control with Resume and Acceleration Features  
 □ Tilt-Away Steering Wheel (Std. on Brougham Sedan)  
 □ Tilt-and-Telescope Steering Wheel  
 □ Simulated Wire Wheel Discs with Locks (Std. on Regency Brougham)  
 □ Pulse Wiper System  
 □ Combination Door and Dual Lens Reading Lamp  
 □ Body Side Two-Tone Paint Scheme  
 □ High Capacity Battery  
 □ Electric Sliding Glass Astroturf (Headroom is reduced with this option)  
 □ Puncture-Sealing Tires  
 □ Cornering Lamps (Std. on Regency Brougham)  
 □ Instrument Panel Gauge Cluster  
 □ Aluminum Styled Wheel (Not avail. until April, 1984)  
 □ Bumper Guards, Rear  
 □ Exterior Lamp Monitor, Front and Rear  
 □ Special Glamour Metallic Paints in Light Blue, Dark Sandstone, Champagne  
 □ Reminder Package, Indicators  
 □ High-Capacity Engine Cooling Systems (Not avail. on V6 diesel)  
 □ Custom Leather Trims in seating areas Maple Red and Medium Maple (Regency), Medium Gray and Maple Red (Regency Brougham)  
 □ Trade Electrical Wiring Harness

**Important: A word about this catalog.** We have tried to make this catalog as comprehensive and factual as possible and we hope you find it helpful. However, since the time of printing, some of the information you will find here may have been updated. Also, some of the equipment shown or described throughout this Olds catalog is available at extra cost. Your dealer has details and, before ordering, you should ask him to bring you up-to-date. The right is reserved to make changes at any time, without notice, in prices, colors, materials, equipment, specifications and models. Check with your Olds dealer for complete information.

**A word about engines:** Some Oldsmobiles are equipped with engines produced by other GM divisions, subsidiaries or affiliated companies worldwide. See your dealer for details. Please refer to the "Fuel Economy Estimate/Engine Supplement Sheet" provided to your dealer for engine source and EPA mileage estimates.

**A word about assembly, components and optional equipment in these Oldsmobile products:** The Oldsmobiles described in this catalog are assembled at facilities of General Motors Corporation operated by Oldsmobile Division, General Motors Assembly Division and GM of Canada. These vehicles incorporate thousands of different components produced by various divisions of General Motors and by various suppliers to General Motors. From time to time during the manufacturing process, it may be necessary, in order to meet public demand for particular vehicles or equipment,

or to meet federally mandated emissions, safety and fuel economy requirements, or for other reasons, to produce Oldsmobile products with different components or differently sourced components than initially scheduled. All such components have been approved for use in Oldsmobile products and will provide the quality performance associated with the Oldsmobile name.

With respect to extra-cost optional equipment, make certain you specify the type of equipment you desire on your vehicle when ordering it from your dealer. Some options may be unavailable when your car is built. Your dealer receives advice regarding current availability of options. You may ask the dealer for this information. GM also requests the dealer to advise you if the option you ordered is unavailable. We suggest that you verify that your car included the optional equipment you ordered or if there are changes, that they are accepted to you.

**Standard occupant-protection features:**

Manual lap/shoulder belts with pushbutton buckles for driver and right front passenger (driver seat includes visual and audible warn-

ing system) • Manual lap belt at center position, when applicable • Manual lap belts with pushbutton buckles at rear passenger positions including the center • Energy-absorbing steering column • Passenger-guard inside door lock handles • Inertia-type folding front seat back latches • Energy-absorbing instrument panel and front seat back tops • Laminated safety-glass windshield/tempered safety-glass side and rear windows • Safety armrests • Front seat head restraint for driver and right front passenger (adjustable or integral).

**Standard accident-avoidance features:** Side marker lights and reflectors • Parking lamps that illuminate with headlamps • Four-way hazard warning flasher • Backup lights • Lane change feature in direction signal control • Windshield defrosters, washers and dual speed wipers • Vinyl-bonded inside mirror glass • Dual outside mirrors • Dual master cylinder brake system with warning light • Starter safety switch • Dual action safety hood latch.

**Standard built-in, anti-theft features:** Audible anti-theft ignition key reminder • Anti-theft steering column lock • Inside hood release.

**A word about updated service information:** Oldsmobile regularly sends its dealers useful service bulletins about Oldsmobile products. Oldsmobile monitors product performance in the field. We then prepare bulletins for servicing our products better. Now you can get these bulletins too. Ask your dealer. To get ordering information call toll free 1-800-551-4123.

There is a special feel  
in an

  
**Oldsmobile**