



Innovation  
that excites

2016  
**GT-R**<sup>®</sup>

**WELCOME TO THE 2016 NISSAN GT-R<sup>®</sup> DIGITAL BROCHURE**

Full of images, feature stories, and all the specification and trim level information you need to help select your GT-R.<sup>®</sup>

[Click here](#) to sign up for news and updates on the 2016 GT-R.<sup>®</sup>





...THE PRODUCTS OF UTTERLY ORIGINAL THINKING  
AND GLORIOUSLY OBSESSIVE ENGINEERING

*EVO, JUNE 2014*

**GT  
R**







**CREATE** a new vision of the supercar. Shrug off the traditional boundaries that say where, when, and how. Because a vehicle this capable, this powerful, this awe-inspiring can be enjoyed every day. In real-world conditions and in places other supercars wouldn't dare to tread.<sup>1</sup> The 2016 Nissan GT-R.<sup>®</sup> Proof that the defining moments in life come when you make **YOUR OWN RULES.**

<sup>1</sup>Driving is serious business and requires your full attention. At all times, obey traffic laws. Not intended for unpaved off-road use. Damage resulting from racing, competitive driving, track and/or airstrip use not covered by warranty. See your New Vehicle Limited Warranty and Owner's Manual for proper vehicle operation and complete warranty details. Always wear your seat belt, and please don't drink and drive.



THE GT-R HAS CHARISMA AND DRIVER APPEAL BY THE  
BUCKET-LOAD, AS WELL AS PERFORMANCE TO SCARE A  
EUROPEAN SUPERCAR OFF THE ROAD...

*CAR MAGAZINE, JUNE 2014*







**A PERSONAL INVITATION TO  
AN UNFORGETTABLE PERFORMANCE.**





**TAKUMI: ONE MAN,  
ONE ENGINE.**

To see the pure passion, the true Japanese DNA of the GT-R<sup>®</sup>, simply lift the hood. Only four master craftsmen in the world are allowed to hand-assemble the GT-R<sup>®</sup>'s engine. They are known as Takumi – a Japanese term used to describe a master craftsman who has perfected his skills over years of painstaking work and dedication. And with over 100 years of combined Takumi experience in building engines, the passion is very, very strong.

Each GT-R<sup>®</sup> engine is assembled by a single craftsman – and proudly bears a plaque carrying his signature. Perfection comes in many ways; each Takumi inspects every piece for quality and to guarantee precision. But it's more than just exceptional skill that goes into the process that makes the GT-R<sup>®</sup> so special. As one of the Takumi says, "We put our souls into each engine, hoping to deliver that excitement to customers."



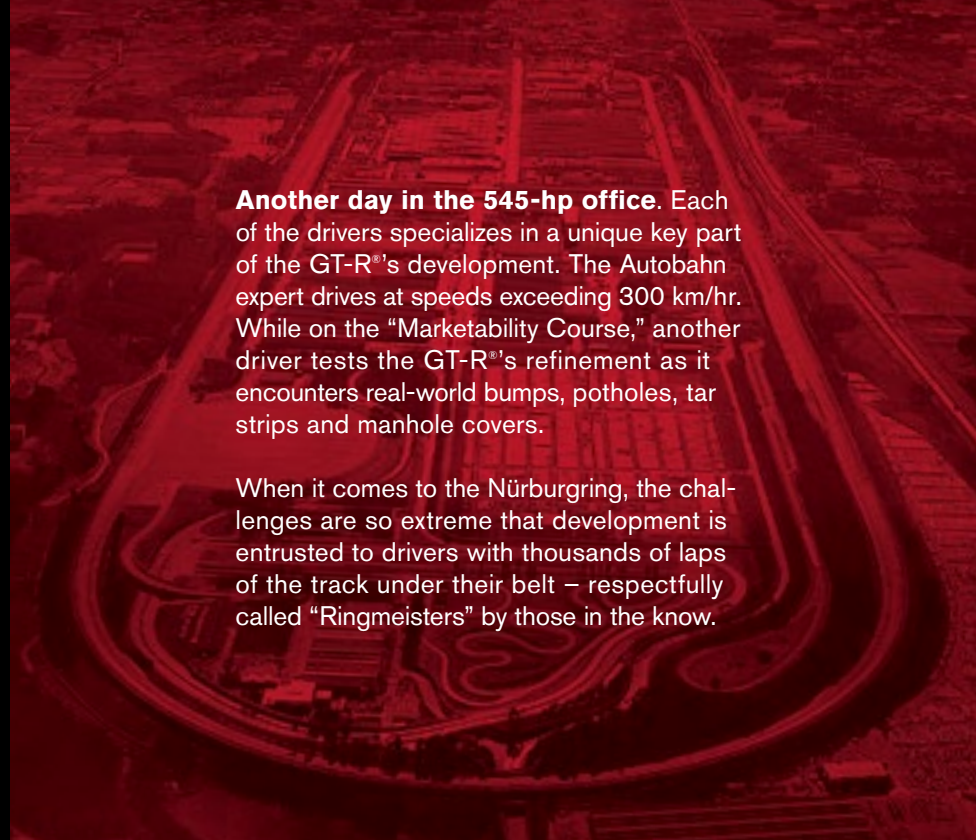

**Another day in the 545-hp office.** Each of the drivers specializes in a unique key part of the GT-R's development. The Autobahn expert drives at speeds exceeding 300 km/hr. While on the "Marketability Course," another driver tests the GT-R's refinement as it encounters real-world bumps, potholes, tar strips and manhole covers.

When it comes to the Nürburgring, the challenges are so extreme that development is entrusted to drivers with thousands of laps of the track under their belt – respectfully called "Ringmeisters" by those in the know.

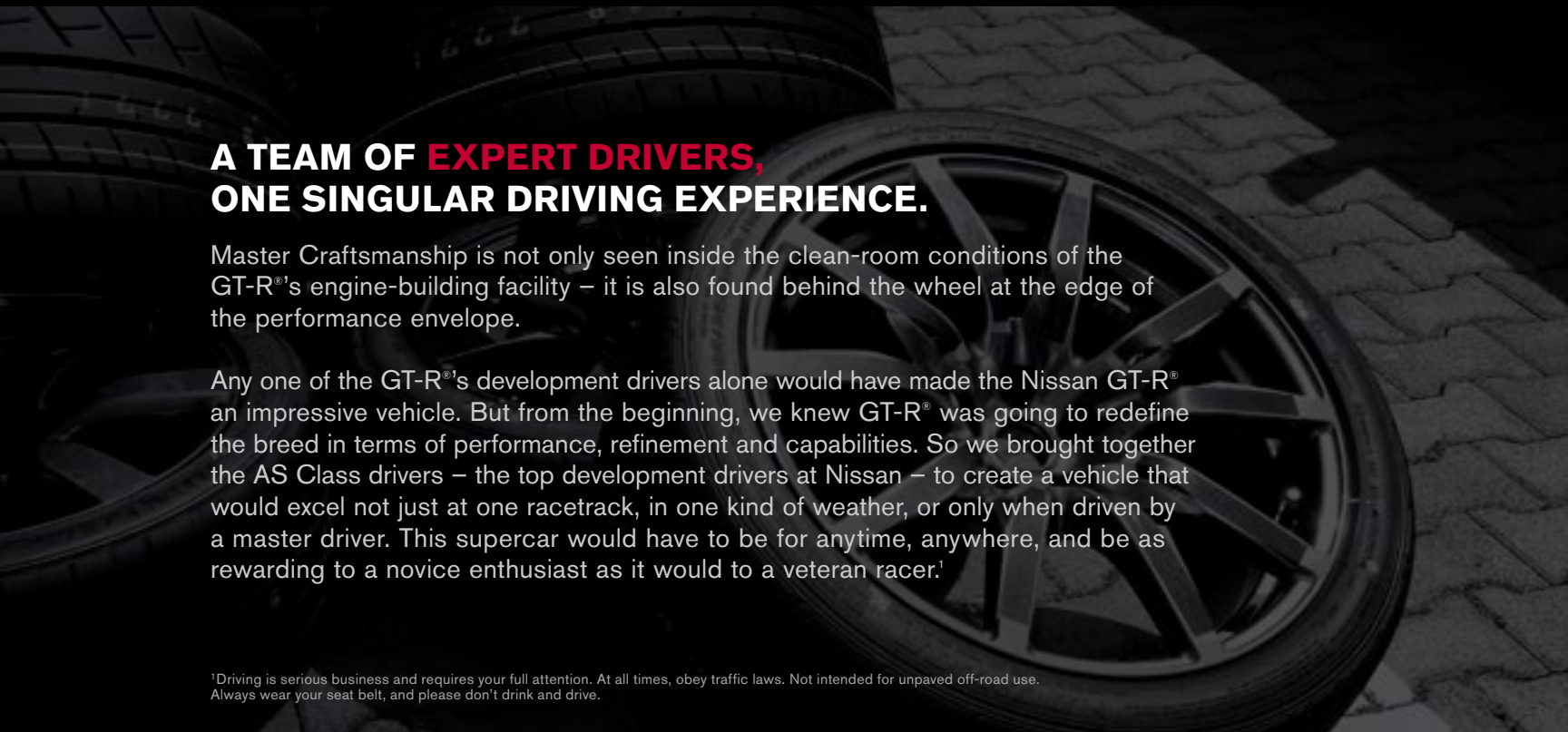

## A TEAM OF **EXPERT DRIVERS,** ONE SINGULAR DRIVING EXPERIENCE.

Master Craftsmanship is not only seen inside the clean-room conditions of the GT-R's engine-building facility – it is also found behind the wheel at the edge of the performance envelope.

Any one of the GT-R's development drivers alone would have made the Nissan GT-R<sup>®</sup> an impressive vehicle. But from the beginning, we knew GT-R<sup>®</sup> was going to redefine the breed in terms of performance, refinement and capabilities. So we brought together the AS Class drivers – the top development drivers at Nissan – to create a vehicle that would excel not just at one racetrack, in one kind of weather, or only when driven by a master driver. This supercar would have to be for anytime, anywhere, and be as rewarding to a novice enthusiast as it would to a veteran racer.<sup>1</sup>

<sup>1</sup>Driving is serious business and requires your full attention. At all times, obey traffic laws. Not intended for unpaved off-road use. Always wear your seat belt, and please don't drink and drive.





# 0.26

## TURNING AN ENEMY INTO AN ALLY.

For supercars, air is the enemy, to be avoided as much as possible. But Nissan employed a unique philosophy to win this battle. Building on Nissan's extensive racing experience, the GT-R® spent two years at the rolling-road wind tunnel at Group Lotus in Europe and 1.5 years in Yoshitaka Suzuka in Japan fine-tuning the secrets of bringing racecar

aerodynamics to the street. The results are an incredibly slippery 0.26 coefficient of drag, impressive downforce for traction and control, and superior air flow management and cooling of key components. Racing technology pays dividends you can enjoy on the street, giving the driver a feeling of superior stability, confidence and control.

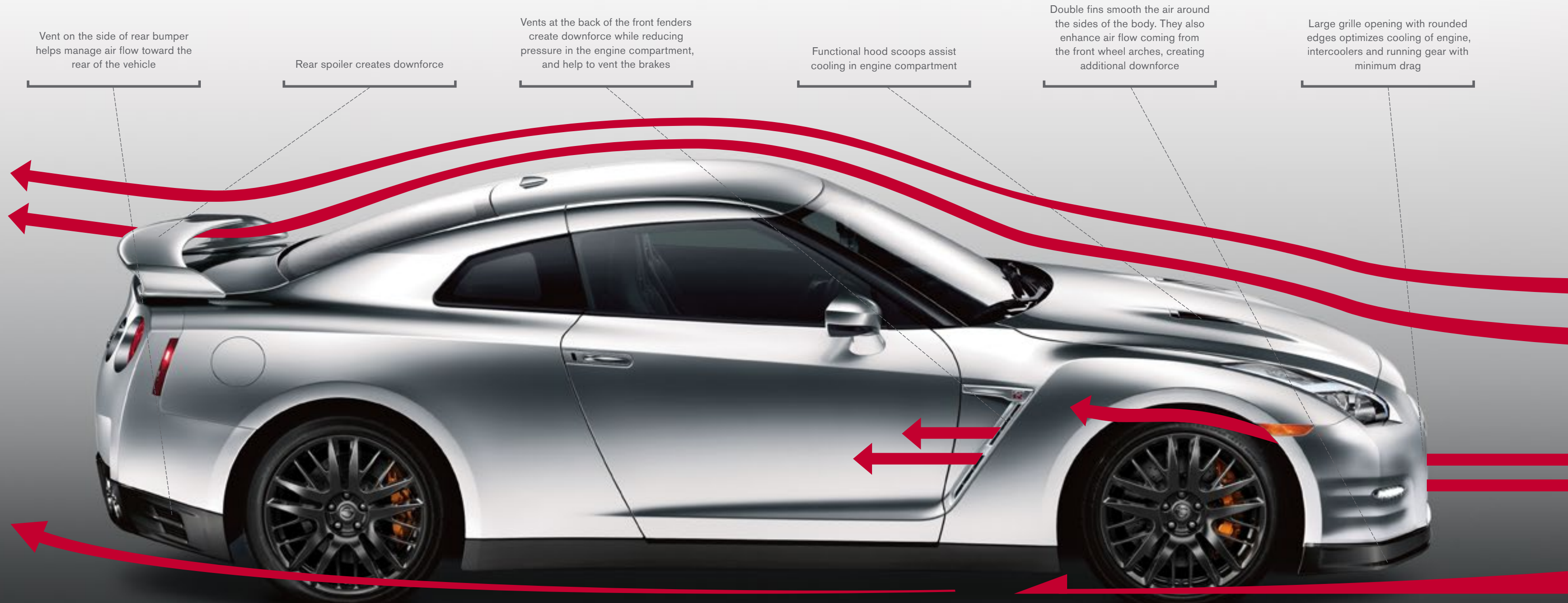



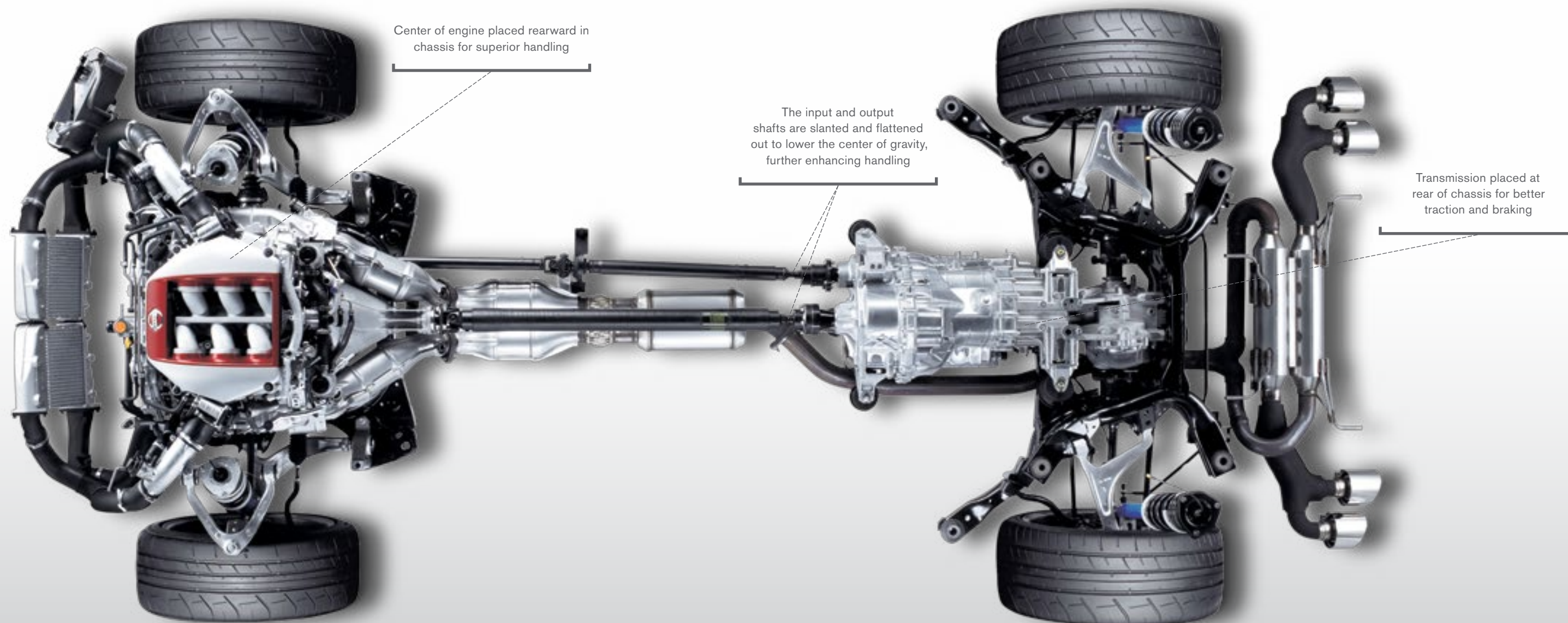

## TO BREAK RECORDS, FIRST YOU BREAK WITH CONVENTION.

When building the GT-R,<sup>®</sup> we followed a philosophy that says nothing is sacred – question everything and come up with new answers to achieve the results desired. A perfect example: GT-R's<sup>®</sup> Premium Midship Platform. By moving the engine farther back in the chassis, it reduces weight over the nose for better handling. In traditional layouts, this would place the transmission rearward, intruding into the passenger cabin. The solution – separate the

transmission from the engine, and mount it with the transfer case in the rear of the vehicle, creating the world's first independent rear transaxle for an All-Wheel Drive vehicle. By putting greater weight over the rear axle, traction and braking are improved. It even creates less heat between engine and transmission, allowing both to run cooler and more efficiently. A brilliant innovation in pursuit of handling perfection.



**Two clutches. No clutch pedal.** The Nissan GT-R®'s 6-speed dual-clutch transmission shifts incredibly quickly. How? Inside the transmission, there are separate clutches for the odd (1st, 3rd, 5th) and even (2nd, 4th, 6th) gears. When the car is in an odd-numbered gear, the adjacent even-numbered gear is "pre-selected" – ready to make the shift immediately. The transmission is so smart, it even "blips" the throttle on downshifts to match rpm. So even though your left leg may not get much exercise, you'll have tremendous fun shifting the GT-R.®



Steering-column-mounted paddle shifters



Transmission settings: R-Mode, Normal and Save

## IT SHIFTS THE WORLD OF TRANSMISSIONS IN JUST 0.15 SECONDS.

The longer a shift takes, the less time power is being put to the ground. So for maximum acceleration, the GT-R®'s paddle-shifted 6-speed sequential dual-clutch transmission can snap off lightning-quick gear changes in just 0.15 seconds when in R-Mode – almost as quickly as you can blink.

# 0.15

Carbon-composite driveshaft

Independent rear transaxle







**196 MPH**  
TOP TRACK SPEED<sup>1</sup>

## 3.8-L V6

**Unconventional wisdom.** Nissan challenged tradition at every point in the GT-R<sup>®</sup>'s development. Instead of a large engine that can be heavy and thirsty for fuel, the GT-R<sup>®</sup> is powered by an ideally sized, twin-turbocharged 3.8-L V6 that produces a prodigious 545 horsepower and equally immense 463 lb-ft of torque. No detail was overlooked: rather than traditional cast-iron liners, each cylinder features a unique plasma coating sprayed onto the cylinder walls. This advanced process greatly helps reduce friction, allowing the engine to spin more freely, helping to reduce wear for added durability, and improving cooling – a uniquely brilliant way to build an engine to perform under brutal conditions.

## 545 HP

**An engine is an air pump.** The better it breathes, the better it works. For maximum performance, the Nissan GT-R<sup>®</sup> features a fully independent intake system for each bank of cylinders. With a special secondary air system that helps heat the catalysts more quickly, the Nissan GT-R<sup>®</sup> is not only powerful, it runs so clean that it's been certified as an Ultra Low Emissions Vehicle (ULEV).

## 463 LB-FT OF TORQUE

**AND BACK**  
COMPETITION-GRADE BRAKING

## 6 PISTON CALIPERS

To complement its incredible horsepower and torque, the GT-R<sup>®</sup> features awe-inspiring braking power. Look beyond the sheer size of the 15.4" front and 15.0" rear brake rotors, and you'll see that Nissan has brought some of the biggest ideas in racing to this extraordinary road car. The brakes feature 6-piston front and 4-piston rear calipers for stronger, more even clamping power – something you'd expect to see on an all-out competition machine. For extreme rigidity with light weight, the caliper is machined from a single one-piece "monoblock" of aluminum.

**Heat is the enemy of any braking system.** It's not uncommon to see the rotors of racecars glowing bright red. Along with cross-drilled rotors to help keep the Nissan GT-R<sup>®</sup>'s brakes cool, you'll find ingenious, diamond-shaped ventilation ribs to pull away heat. The GT-R<sup>®</sup> also benefits from a full-floating rotor – a race-bred technology. By allowing the outer disc to expand away from the hub under extreme heat, it helps reduce the tendency of the rotor to warp.



<sup>1</sup>Driving is serious business and requires your full attention. At all times, obey traffic laws. Not intended for unpaved off-road use. Damage resulting from racing, competitive driving, track and/or airstrip use not covered by warranty. See your New Vehicle Limited Warranty and Owner's Manual for proper vehicle operation and complete warranty details. Always wear your seat belt, and please don't drink and drive. Brembo<sup>®</sup> is a registered trademark of Freni Brembo S.p.A.





## **IT CORNERS LIKE IT IS READING YOUR MIND.**

In GT-R<sup>®</sup>, you'll find massive grip combined with refinement befitting a true Grand Touring machine. The suspension is designed to help filter out the bumps and noise while still telling you everything you need to know. Steering effort is reduced at lower speeds for easier in-town maneuvering, while still delivering the precision you desire. It all adds up to a supreme balance. One that lets you feel fully confident, that lets you enjoy 545 thoroughbred horsepower and the adrenaline rush that comes from charging out of a turn with perfect balance at your fingertips.

The Nissan GT-R<sup>®</sup>'s ground-hugging aerodynamics plus powerful brakes allow it to carry speed much later into the turn. But the real key to its quickness is the All-Wheel Drive's ability to put the power down much sooner in a corner. In contrast, as they approach the limit of cornering grip, many powerful Rear-Wheel Drive cars require the driver to wait before applying power until the exit of the corner to avoid upsetting the handling of the car.





## MAKE ANY CONDITION “SUPERCAR WEATHER!”

While most supercars must stay in the garage, or make a hasty retreat to warmer climates, GT-R’s advanced All-Wheel Drive gives you confidence in slippery conditions. One of the most advanced All-Wheel Drive systems ever used in a road car, the system helps provide control of power to all four wheels. Combined with an equally advanced stability control system,<sup>1</sup> the result is a superior sense of confidence. Your calendar of great driving days has just opened up.<sup>2</sup>

**Biased performance.** Instead of the traditional 50/50 torque split between front and rear axles, the Nissan GT-R’s electronically controlled All-Wheel Drive system is designed to provide up to nearly 100% of available torque to the rear wheels, and can send up to 50% of torque to the front wheels as needed. This provides the steering feel and response of a Rear-Wheel Drive vehicle – the preferred choice of racecar drivers and serious enthusiasts – while still giving the added confidence and controllability that only an All-Wheel Drive vehicle can offer.<sup>2</sup>



# 4

**VDC that pulls for you.** Most stability control systems cut engine power or apply the brakes when they sense a loss of control. Fine for the road, but slow going in competition conditions on the track. While cornering with the Nissan GT-R’s advanced Vehicle Dynamic Control (VDC) system in R-Mode, it actually sends more power to the appropriate wheels when it senses oversteer or understeer, helping you drive with superior power and control!<sup>1</sup>

<sup>1</sup>VDC, which should remain on when driving except when freeing the vehicle from mud or snow, cannot prevent accidents due to abrupt steering, carelessness, or dangerous driving techniques. <sup>2</sup>Driving is serious business and requires your full attention. At all times, obey traffic laws. Not intended for unpaved off-road use. Damage resulting from racing, competitive driving, track and/or airstrip use not covered by warranty. See your New Vehicle Limited Warranty and Owner’s Manual for proper vehicle operation and complete warranty details. Always wear your seat belt, and please don’t drink and drive.



## THE DRIVE YOU DESIRE, JUST A FINGERTIP AWAY.

Whether you're out for a leisurely cruise, on your favorite track, or anywhere in between, GT-R's easy-to-use 3-mode system is always ready.<sup>1</sup> Three switches allow for on-the-fly adjustment of specific performance parameters for the transmission, suspension and Vehicle Dynamic Control (VDC).<sup>2</sup> This is performance with amazing flexibility, all at the flip of a switch.

	R-MODE	NORMAL MODE	SPECIAL MODE
<b>Transmission</b>	For maximum performance with the quickest shifts.	For maximum smoothness.	Save mode – For long-distance driving and gentler torque delivery for smooth driving on slippery surfaces.
<b>Suspension</b>	For high-performance cornering. The damping force of the shock absorbers is set for maximum vehicle performance.	For automatic electronic control of damping.	Comfort mode – The damping force of the shock absorbers is variably adjusted for more comfort.
<b>VDC<sup>2</sup></b>	For ultimate performance. Adjusts front and rear wheel power distribution to enhance handling.	For daily driving. Controls brakes and engine output.	Off mode – Disengages the VDC system. <sup>2</sup>

<sup>1</sup>Driving is serious business and requires your full attention. At all times, obey traffic laws. Not intended for unpaved off-road use. Damage resulting from racing, competitive driving, track and/or airstrip use not covered by warranty. See your New Vehicle Limited Warranty and Owner's Manual for proper vehicle operation and complete warranty details. Always wear your seat belt, and please don't drink and drive. <sup>2</sup>VDC, which should remain on when driving except when freeing the vehicle from mud or snow, cannot prevent accidents due to abrupt steering, carelessness, or dangerous driving techniques.



The image shows the interior of a car, focusing on the front seats. The seats are upholstered in a light cream or beige leather with a perforated texture on the lower backrests. The seats feature a sporty design with multiple horizontal and vertical stitching lines. The driver's seat is in the foreground, and the passenger seat is visible behind it. The center console and door panels are also visible, showing a mix of black and cream-colored materials. The steering wheel is partially visible on the left side of the frame. The overall lighting is soft, highlighting the texture and stitching of the leather.

## COMPLETELY CAPTIVATING, EVEN AT REST.

Available leather appointments on the center console, door panels and shift lever surround you in comfort, while available semi-aniline leather appointments and double stitching on the seats are a tactile and visual feast.

To enhance your drive, Active Noise Cancellation uses information received from the engine along with a microphone located in the cabin to identify undesirable engine sounds. The system then reproduces an acoustically opposite signal through the sound system, cancelling much of the unwanted noise, letting you savor the invigorating sounds of GTR®'s engine even more.



## ARTFULLY STATE-OF-THE-ART.

The 11-speaker Bose® audio system was designed along with the vehicle itself. The die-cast aluminum structures in the doors and behind the rear seats not only make the car incredibly rigid, they're also an ideal way to mount speakers for optimum sound. Even the dual subwoofers between the rear seats were developed especially for the GT-R®. Angled specifically to work in concert with the sounds of the car, the subwoofers are mounted in a way to employ the trunk as a giant enclosure, for incredibly deep, rich bass.

iPod® or flash drive connectivity via USB input<sup>1</sup>

Plays MP3/WMA CDs or DVDs

DVD video playback

SiriusXM® Satellite Radio<sup>2</sup>

Streams music from any compatible device via Bluetooth® wireless technology<sup>3</sup>

**A supercar shouldn't just be great on the open roads** – it should also help you find them. With Nissan GT-R®'s touch-screen navigation system<sup>4</sup> with voice recognition and a high-resolution screen, the world is at your command. It features a hard drive-based system for quick response, while NavTraffic®<sup>2</sup> advisories in real time help keep you ahead of the crowd. You can even keep track of the weather with NavWeather.®<sup>2</sup> And with DVD playback capability and a USB iPod® input, the entertainment will have no problem keeping pace.<sup>1</sup> The system also includes a convenient RearView Monitor with a new wide 180° view that gives you a wider perspective on the monitor, so even parking is a quick and easy affair.<sup>5</sup>



<sup>1</sup>Driving is serious business and requires your full attention. If you have to use the connected device while driving, exercise extreme caution at all times so full attention may be given to vehicle operation. iPod® is a registered trademark of Apple, Inc. All rights reserved. iPod® not included. <sup>2</sup>Required SiriusXM® Satellite Radio, NavTraffic® and NavWeather® subscriptions sold separately after trial period. Installation costs, one-time activation fee, other fees and taxes will apply. NavTraffic® available in select markets. Services available only to those 18 or older in the 48 contiguous states and D.C. Fees and programming subject to change. Subscriptions governed by Customer Agreement available at [siriusxm.com](http://siriusxm.com). ©2015 Sirius XM Radio Inc. Sirius®, XM® and all related marks and logos are trademarks of Sirius XM Radio Inc. <sup>3</sup>Availability of specific features is dependent upon the phone's Bluetooth® support. Please refer to your phone Owner's Manual for details. Bluetooth® word mark and logos are owned by Bluetooth SIG, Inc., and any use of such marks by Nissan is under license. <sup>4</sup>Never program while driving. GPS mapping may not be detailed in all areas or reflect current road status. <sup>5</sup>Parking aid/convenience feature. Cannot completely eliminate blind spots. May not detect every object and does not warn of moving objects. Always check surroundings and turn to look behind you before moving vehicle. Bose® is a registered trademark of The Bose Corporation.





Special attention to ergonomics means the Nissan GT-R® feels familiar the moment you sit down – all gauges, including the Multi-Function Display system, are on the same plane, making for an easy scan, while instruments are large, clear, and simple for maximum legibility.

Intuitive by design. Switchgear – from the door to the steering wheel-mounted controls to audio, climate control and the three setup switches – are at a similar height and are grouped by shape and function.

**ERASING THE LINE WHERE THE DRIVER ENDS AND THE GT-R® BEGINS.**



## INFORMATION TRAVELING AT THE SPEED OF GT-R.<sup>®</sup>

Like everything else in the GT-R,<sup>®</sup> Nissan rethought the way the driver receives information. Multiple, easily accessed screens are an innovative way the driver can get immediate feedback to key performance parameters. The result is engaging and informative – providing quick readability combined with the flexibility of multiple customizable displays.



**Five customizable performance screens** are designed to let the driver organize key information to their personal tastes. Choose from a variety of engine performance and efficiency parameters, as well as monitoring cornering and acceleration/braking G-forces.

**Factory preset screen.** For proof of the GT-R's dedication to performance, look no further than the factory preset screen – a dedicated stopwatch activated from the steering wheel. You can even store your track times on a flash drive using the USB port in the center console.<sup>1,2</sup>



<sup>1</sup>Driving is serious business and requires your full attention. At all times, obey traffic laws. Not intended for unpaved off-road use. Damage resulting from racing, competitive driving, track and/or airstrip use not covered by warranty. See your New Vehicle Limited Warranty and Owner's Manual for proper vehicle operation and complete warranty details. Always wear your seat belt, and please don't drink and drive. <sup>2</sup>Driving is serious business and requires your full attention. If you have to use the connected device while driving, exercise extreme caution at all times so full attention may be given to vehicle operation. External device not included.







7:38.5

2007 // GT-R\*

7:26.7

2009 // GT-R\*

7:18.6

2012 // GT-R\*

7:08.679

September 30, 2013  
// GT-R\* NISMO\*  
(with track options)



## EVOLUTION NEVER STOPS FOR THE NISSAN GT-R.®

**It has always been about passion.** The Nürburgring is the great equalizer when it comes to supercar performance. Manufacturers from around the world come here to test and develop their ultimate performance machines. And for the very finest, there's always the challenge of setting record times.

During testing in 2007, the all-new GT-R® created a sensation when it posted an official 7-minute, 38.5-second lap – one of the fastest laps ever posted around Germany's legendary Nürburgring.<sup>1</sup> But for team GT-R®, it was just the beginning. In 2009, the GT-R® sent another shock wave through the performance world with an unofficial time of 7 minutes, 26.7 seconds. Why stop at just one lap? In May 2012, the GT-R® returned to the Nürburgring to compete in a grueling 24-hour race. Against full-on race cars, the stock production GT-R® took incredible punishment, and was able not only to finish – it was first in class.<sup>2</sup>

Driven to constantly improve, on September 30, 2013, the 2015 GT-R® NISMO® with track options took to the Nürburgring, and ran an incredible 7:08.679. We cheered. We celebrated. And then we went back to work. Because where others see a finish line, we just see the start of the next lap.

The "Green Hell." Welcome to the Nürburgring, the world's most torturous track. 13 miles long, 73 bends in the picturesque Eifel mountains of Germany. The GT-R® logged thousands of miles at the 'Ring, consistently recording lap times only matched by a few of the world's most capable – and most expensive – production cars.





**YOU SEE IT, AND YOU JUST KNOW...**



## GT-R® HIGH-PERFORMANCE GUIDE

### ENGINE

#### VR38 Twin Turbo Engine

An engine designed to answer the demands of a supercar for the 21st century, the VR38 is high-performance, while still being fuel-efficient and conscious of the environment.

#### IHI Integrated Turbocharger

An IHI turbocharger is mounted on each bank of the engine. By combining the exhaust manifold and turbocharger into a single unit, the intake and exhaust gas flow is optimized. A larger intercooler is installed for more efficient cooling. To ensure there is no turbo lag as torque rises, high-precision electronic controls are employed.



**545 HP** The perfect blend of size and power

#### Closed Deck and Ladder Frame Structure

The cylinder block features a closed deck for strength. For added strength, a ladder frame structure was also adopted to give the crankshaft added support, important with the engine's massive torque. Magnesium alloy was selected for the oil pan and rocker cover for its light weight and strength.

#### Independent Intake and Exhaust System

For higher horsepower and better response than a naturally aspirated engine, each side of the VR38 features its own turbocharger, intercooler, and catalyst. By employing an independent intake and exhaust system for each side of the V6, intake air flow is increased and exhaust back-pressure is decreased.

#### Plasma Coating Bore

Innovative plasma-sprayed bores are used in each cylinder instead of traditional cast-iron liners. This enhances cooling, reduces friction and weight while maximizing horsepower and increasing fuel-efficiency. Compared to the cast-iron liner, the overall weight decreased by approximately 6.6 pounds (3 kg).

#### Oil Cooler with Thermostat

For optimal control of engine cooling, the VR38 features a thermostatically controlled oil cooler system. A scavenger pump is employed to help keep oil flowing to the turbochargers, even during the strong lateral Gs experienced on a racecourse.

The GT-R's Premium Midship (PM) platform layout places the transmission, transfer case and final drive at the rear of the vehicle without the use of traditional torque tubes, allowing the suspension to operate independently and optimizing tire grip at each corner.

This enables the use of the world's first independent rear transaxle All-Wheel Drive system. To further enhance handling, the input and output shafts are slanted and flattened out to lower the center of gravity.

### TRANSMISSION

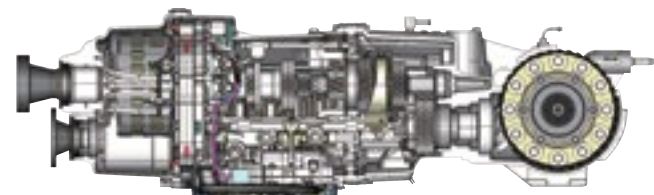

World's first independent rear AWD transaxle

**GR6**

#### Dry Sump Lubrication System

To ensure stable lubrication for the transmission even when cornering at high Gs, a dry sump lubrication system is employed. The system sprays transmission oil directly onto the gears, reducing friction and increasing reliability.

#### ATTESA E-TS® All-Wheel Drive System

The ATTESA E-TS® is a Rear-Wheel Drive biased system that can vary torque split from 2:98 to 50:50 depending on speed, lateral acceleration, steering angles, tire slip, road surface and yaw rate. A GT-R®-specific yaw-rate feedback control measures the differences between the target yaw rate calculated from steering angle and actual yaw rate detected by the yaw-rate sensor and G sensor and adjusts torque bias to help follow the driver's steered line.

### AERODYNAMICS



**0.26Cd** High downforce with an ultra-low coefficient of drag

Aerodynamics figured prominently in the development of the GT-R®. Generally, the lower the coefficient of drag (the resistance to air), the lower the downforce, which aids grip and handling. Thanks to the GT-R's Premium Midship Package, the GT-R® was able to create a strong downforce while capping the Cd at 0.26. And by using aerodynamics to actively cool the powertrain and brakes, a better overall performance was made possible.

### BODY

#### Multi-material Body Structure

The GT-R's body gets impressive strength from Carbon Aluminum Die-cast Steel.<sup>1</sup>

For structural rigidity, aluminum die-cast door inner panels are employed. In addition, die-cast aluminum is also used for the front strut housing and in the front suspension. For added structural rigidity, the suspension's strut tower bar is made of a lightweight carbon composite containing aluminum honeycomb.



#### Anti-chipping Body Coating, Double Clearcoat, and Scratch Shield

At the velocity the GT-R® can attain, even the smallest stones can cause extensive damage to the vehicle's finish. To help keep the GT-R® looking new, models finished in available Deep Blue Pearl, Gun Metallic, Solid Red and Super Silver<sup>1</sup> feature an innovative anti-chipping coating applied to the top of the front grille and the front of the rear fender – the two places most prone to chipping during driving. In addition, a double clearcoat helps protect the finish. Vehicles finished in available Pearl White,<sup>1</sup> Jet Black and Regal Red<sup>1</sup> feature a Scratch Shield, a clearcoat that is more scratch resistant compared with conventional clearcoats, helping a vehicle maintain its new look for a longer period of time.

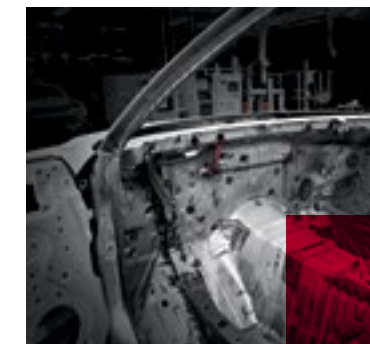

Lightweight, yet incredibly strong



#### Hyper LED Driving Lights

For greater visibility from other vehicles, the GT-R® features Hyper LED Driving Lights. Despite their compact size, the LED lights are highly visible, even in broad daylight.

<sup>1</sup>Extra cost option.



## GT-R® HIGH-PERFORMANCE GUIDE

### CHASSIS



From a smooth, civilized ride to racetrack-ready performance at the touch of a button.<sup>1</sup>

Handling duties are managed by a sophisticated 4-wheel independent suspension system mounted to high-precision 6-point front and rear subframes. A special Bilstein® DampTronic® driver-adjustable shock absorber system utilizes multiple vehicle information systems to provide appropriate damping forces and a high level of control for a variety of driving situations.

The DampTronic® system features three driver-selectable settings – Normal; Comfort, for maximum suspension compliance; or R for sporty driving. The system is exceptionally advanced – the electronic controller of the damping force optimally manages 11 types of vehicle data.



The GT-R® runs on Dunlop® SP Sport Maxx GT 600 DSST CTT high-performance run-flat nitrogen-filled tires designed to match the suspension characteristics. Standard tire sizes are 255/40ZRF20 front and 285/35ZRF20 rear. Taking advantage of GT-R®'s anytime, anywhere capability, optional Dunlop® SP 7010 all-season run-flat tires are offered as part of the Cold Weather Package.<sup>2,3</sup>



The Nissan GT-R®'s rigid forged aluminum 20-inch wheels, manufactured by RAYS®, utilize knurling inside the wheels to help keep the tires from slipping around the wheels under heavy acceleration or braking. The wheels feature a premium dark (near black) finish, which provides a high-quality, high-performance look. The Black Edition features special metallic dark-finished 6-spoke RAYS® forged lightweight wheels in place of the Premium model's 20-spoke design.

Stopping power is provided by a high-performance braking system developed by Nissan for the GT-R®. The system features Brembo® monoblock 6-piston front and 4-piston rear calipers.

15.35-inch front and 15.0-inch rear Brembo® full-floating cross-drilled two-piece rotors and low-steel high-stiffness brake pads help minimize fade and help provide powerful stopping performance. The calipers utilize racecar-style radial mounting to help minimize caliper flex during extreme braking.



Calipers machined from a single “monoblock” of aluminum.

# 15" ROTORS

### SETUP SWITCH

The heart of the GT-R®'s anytime, anywhere performance,<sup>1</sup> the system allows adjustment of the settings at a touch of a fingertip. The transmission, shock absorbers and VDC<sup>4</sup> vehicle dynamic control can each be shifted into three modes: ‘R’ mode, ‘NORMAL’ mode and individual modes for each system. Combined with the choice of automatic or manual shifting, these modes help give the driver exhilarating performance and control, whether on the circuit, on the highway in the rain or snow, even on rough road surfaces on city streets.

Street to Track at Your Fingertips.



### COCKPIT

The combination uses meshing gears as its motif. The tachometer is placed in the center, with the large-scale shift indicator on the upper right, supporting the driver with immediate readability when driving on the circuit.<sup>1</sup>



So advanced, it can even help you become a better driver.

#### Multi-Function Meter

On the center display, a 7-inch wide LCD monitor, the multi-function meter, displays the vehicle condition and driving log. For example, when driving on a circuit, the system gives the driver detailed information to help understand the condition of the car. The braking and steering display shows the corresponding log on lateral G and longitudinal G for 20 seconds. A recording feature with playback lets the driver see how they were able to control the car during cornering, or how much unnecessary movement took place – information that can be used to improve driver technique.

## RECARO® SEATS

The Interface Between Driver and GT-R®

The standard for comfort and control. On select GT-R® models, the front driver and passenger seat are designed by legendary manufacturer Recaro. Deep bolsters are designed to help hold the driver and passenger in place, even during the most strenuous cornering. Superb support also makes the Recaro® an excellent seat for grand touring. On the GT-R® Black Edition, the seats are leather-appointed in a black and red contrasting color scheme.

Developed exclusively for GT-R®, the headlights feature four LED units to create an extremely natural light, replicating daylight, while also offering increased illumination. The super-wide-beam headlights expand the area of illumination toward the sides of the front of the car, enhancing visibility, especially when cornering. The super-wide-beam's range is so expansive, front fog lights are unnecessary. And while the headlights are great for the driver, they are also considerate of others – the three supporting reflectors illuminate a large area of the side of the car without blinding oncoming traffic.

# LED

Super-wide-beam Headlights.  
A Revolution in Illumination.



<sup>1</sup>Driving is serious business and requires your full attention. At all times, obey traffic laws. Not intended for unpaved off-road use. Damage resulting from racing, competitive driving, track and/or airstrip use not covered by warranty. See your New Vehicle Limited Warranty and Owner's Manual for proper vehicle operation and complete warranty details. Always wear your seat belt, and please don't drink and drive. <sup>2</sup>Driving is serious business and requires your full attention. At all times, obey traffic laws. Not intended for unpaved off-road use. Always wear your seat belt, and please don't drink and drive. <sup>3</sup>Always use appropriate tires for weather conditions. See Owner's Manual for details. Failure to use appropriate tires could cause an accident resulting in serious injury or death. <sup>4</sup>VDC, which should remain on when driving except when freeing the vehicle from mud or snow, cannot prevent accidents due to abrupt steering, carelessness, or dangerous driving techniques. Alcantara® is a registered trademark of Alcantara S.p.A. Corporation. Bilstein® and DampTronic are registered trademarks of ThyssenKrupp Bilstein GmbH. Brembo® is a registered trademark of Freni Brembo S.p.A. Dunlop® is a registered trademark of DNA Ltd. Corporation. RAYS® is a registered trademark of RAYS Engineering. Recaro® is a registered trademark of Recaro North America Inc.





The connection between driver and machine gets even more intimate with the GT-R® Black Edition's supremely supportive Recaro® leather-appointed front seats. Matching red leather appointments on the door pulls and the shift lever are a perfect complement to the contrasting panels on the seats, with the finishing touch of red accents on the steering wheel to create a driver's environment that is as inspiring to look at as it is to employ. Equally exhilarating, the Black Edition rides on 6-spoke special lightweight forged aluminum wheels, measuring 20" x 9.5" in front and 20" x 10.5" at the rear. A dry carbon-fiber composite rear spoiler ensures that the final impression you leave will be a most memorable one.<sup>1</sup>

## GT-R® BLACK EDITION DESIGNED FOR THE PURIST.

**Performance art.** The Black Edition's rear spoiler is as breathtaking to the eye as it is slippery to the wind. Handmade in a limited monthly production run, the lightweight dry carbon-fiber is also incredibly strong. To make it a feast for the senses, a special coating allows you to feel the weave of the carbon-fiber.<sup>1</sup>





**NISSAN GT-R® NISMO®  
SIMPLY THE DOMINANT SUPERCAR OF ITS TIME.**

**600  
HP**

**Constantly improving.** During testing in 2007, the GT-R® posted an official 7-minute, 38.5-second lap – one of the fastest laps ever posted around Germany's legendary Nürburgring. On September 30, 2013 the GT-R® NISMO® posted a timed lap of 7:08.679 – nearly 30 seconds faster – an incredible feat of engineering and driver skill.<sup>1,2</sup>

**481 lb-ft of torque**

**220 lbs. of additional downforce**

**0.26 coefficient of drag**

**NISMO® unique 6-spoke wheels**

**NISMO® carbon-fiber body kit**

Pure. Undiluted. Awe-inducing. With 600 horsepower of fury combined with unmatched control. From its high capacity turbos to its specially tuned suspension, this is the ultimate GT-R®.

On the outside, a competition-developed body kit adds an additional 220 lbs. of downforce with a unique rear spoiler and carbon-fiber bumpers, trunk lid and side sills. Subtle yet special, contrasting dark gray mirrors feature a red accent stripe. The entire body sits poised over unique front and rear alloy wheels, wearing specially developed Dunlop® tires.

Inside is just as focused, with Recaro® seats, an Alcantara®-wrapped steering wheel with red leather stripe at 12 o'clock, and a signature NISMO® red throughout the cabin, including the seatbacks, tachometer face, shift lever and door handle pulls.

**nismo®**



<sup>1</sup>2007 Testing based on GT-R® pre-production model. 2013 Testing based on time at Nürburgring time attack set by 2015 GT-R® NISMO® with track options. <sup>2</sup>Driving is serious business and requires your full attention. At all times, obey traffic laws. Not intended for unpaved off-road use. Damage resulting from racing, competitive driving, track and/or airstrip use not covered by warranty. See your New Vehicle Limited Warranty and Owner's Manual for proper vehicle operation and complete warranty details. Always wear your seat belt, and please don't drink and drive. Alcantara® is a registered trademark of Alcantara S.p.A. Corporation. Dunlop® is a registered trademark of DNA Ltd. Corporation. Recaro® is a registered trademark of Recaro North America Inc.



BECAUSE YOU'RE NOT DRIVING A CAR,  
YOU'RE DRIVING A LEGEND.

## GENUINE NISSAN ACCESSORIES

Every Genuine Nissan Accessory is custom-fit, custom-designed and durability-tested. Each one is backed by Nissan's 3-year/36,000-mile (whichever occurs first) limited warranty (if installed by dealer at the time of purchase),<sup>1</sup> and can be financed when installed by dealer at time of purchase.

**GT-R® Genuine Branded Merchandise** includes apparel, lifestyle, and sports and leisure equipment to show your passion wherever you – and your GT-R® – go.

**A. Premium Sport Floor Mats with Carbon-fiber Inserts**

The ultimate mat for the ultimate supercar.

**B. GT-R® Tech Performance Polo Shirt**

Expressive style. Available in black and white, in men's and women's sizes.

**C. Vehicle Cover**

Like lingerie for your GT-R®, with a stretch satin custom cover for a perfect fit and a soft fleece inner liner to protect the finish. Available in gray or black.

**D. Chrome Jack with GT-R® Logo**

Exquisitely detailed, it will give you a lift every time you look at it.

**E. GT-R® Carpeted Floor Mats**

Preserve and protect your GT-R®.

**F. Nissan Valve Stem Caps**

Show your Nissan pride.

**G. Wheel Locks**

Four Wheel Locks and coded Wheel Lock Socket keep your wheels out of the wrong hands.

**Additional Accessories:**

- Standard Tool Kit
- Emergency Road Kit
- Vehicle Cover Cable Lock
- Ash Cup

For more information and to shop online for GT-R® Genuine Nissan Accessories, go to [bit.ly/16gtr-estore](http://bit.ly/16gtr-estore)



<sup>1</sup>Genuine Nissan Accessories are covered by Nissan's Limited Warranty on Genuine Nissan Replacement Parts, Genuine NISMO® S-Tune Parts, and Genuine Nissan Accessories for the longer of 12 months/12,000 miles (whichever occurs first) or the remaining period under the 3-year/36,000-mile (whichever occurs first) Nissan New Vehicle Limited Warranty. Terms and conditions apply. See Warranty Information Booklet for details.



## CHOOSE YOUR TRIM LEVEL

### PREMIUM

- 3.8-liter twin-turbo V6 engine
- Dual-clutch 6-speed transmission
- ATTESA E-TS® All-Wheel Drive
- 20" Super-lightweight RAYS® forged-alloy wheels
- Dunlop® SP Sport MAXX GT600 DSST CTT high-performance run-flat tires
- Nissan/Brembo® braking system
- Bilstein® DampTronic® suspension system
- Advanced Vehicle Dynamic Control (VDC)<sup>1</sup> with three driver-selectable modes
- Multi-LED headlights with signature lighting
- Nissan Hard Drive Navigation System
- Driver-configurable Multi-Function Display system
- Bose® audio system with Active Noise Cancellation (ANC)
- Leather-appointed front seats with synthetic suede inserts

#### KEY AVAILABLE PACKAGES:

- Premium Interior Package
- Cold Weather Package



### GT-R® NISMO®

#### INCLUDES PREMIUM EDITION EQUIPMENT PLUS:

- NISMO®-tuned 600-hp, 3.8-liter, high-capacity twin-turbocharged V6 engine
- NISMO®-tuned suspension
- NISMO®-tuned 17.3-mm hollow rear stabilizer bar
- NISMO® Black 20" super-lightweight RAYS® forged-alloy wheels
- NISMO® aerodynamic body design – carbon-fiber front and rear fascia, side sills and rear spoiler
- Additional front and rear brake cooling air ducts
- Carbon-fiber trunk lid
- NISMO® tachometer
- NISMO® Recaro® leather-appointed front seats with red Alcantara® inserts
- NISMO® Black/Red interior treatment
- NISMO® Alcantara®-wrapped steering wheel and gauge hood



### BLACK EDITION

#### INCLUDES PREMIUM EDITION EQUIPMENT PLUS:

- 20" Special dark-finished super-lightweight forged-alloy RAYS® wheels
- Dry carbon-fiber rear spoiler<sup>2</sup>
- Black/Red Recaro® leather-appointed front seats



### 45<sup>TH</sup> ANNIVERSARY GOLD EDITION<sup>3</sup>

#### INCLUDES PREMIUM EDITION EQUIPMENT PLUS:

- Unique 45th Anniversary Gold color
- Commemorative interior plaque
- Gold-tone VIN plate in engine compartment



<sup>1</sup>VDC, which should remain on when driving except when freeing the vehicle from mud or snow, cannot prevent accidents due to abrupt steering, carelessness, or dangerous driving techniques. <sup>2</sup>Dry carbon-fiber requires specific maintenance. Please see your Owner's Manual for details. <sup>3</sup>Limited production color. Alcantara® is a registered trademark of Alcantara S.p.A. Corporation. Bilstein® and DampTronic® are registered trademarks of ThyssenKrupp Bilstein GmbH. Bose® is a registered trademark of The Bose Corporation. Brembo® is a registered trademark of Freni Brembo S.p.A. Dunlop® is a registered trademark of DNA Ltd. Corporation. RAYS® is a registered trademark of RAYS Engineering. Recaro® is a registered trademark of Recaro North America Inc.



CHOOSE YOUR FABRIC

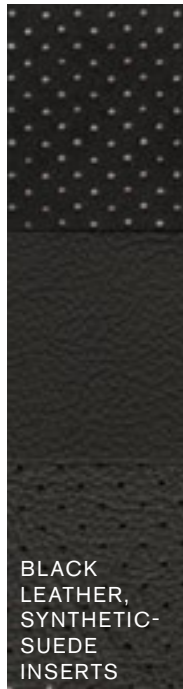

BLACK  
LEATHER,  
SYNTHETIC-  
SUEDE  
INSERTS



RED AMBER  
SEMI-ANILINE  
LEATHER

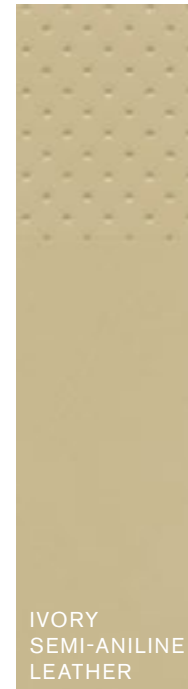

IVORY  
SEMI-ANILINE  
LEATHER

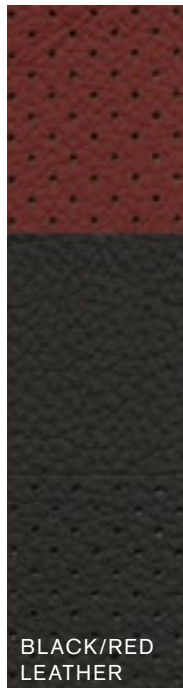

BLACK/RED  
LEATHER

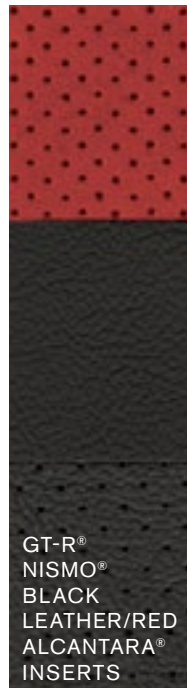

GT-R®  
NISMO®  
BLACK  
LEATHER/RED  
ALCANTARA®  
INSERTS

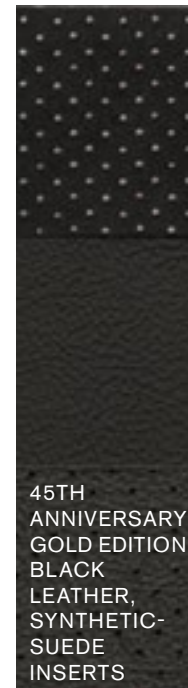

45TH  
ANNIVERSARY  
GOLD EDITION  
BLACK  
LEATHER,  
SYNTHETIC-  
SUEDE  
INSERTS









## SPECIFICATIONS

Engine	Premium	Black Edition	GT-R® NISMO®
<b>VR38DETT – 3.8-liter twin-turbocharged 24-valve V6</b>	■	■	
– Horsepower – 545 horsepower @ 6,400 rpm			
– Torque – 463 lb-ft of torque @ 3,200–5,800 rpm			
– Cylinder bore x stroke – 95.5 x 88.4 mm			
– Top speed – 196 mph			
– Emissions – 50 State LEV2/ULEV			
<b>NISMO®-tuned VR38DETT – 3.8-liter high-capacity twin-turbocharged 24-valve V6</b>			■
– Horsepower – 600 horsepower @ 6,800 rpm			
– Torque – 481 lb-ft of torque @ 3,200–5,800 rpm			
– Cylinder bore x stroke – 95.5 x 88.4 mm			
– Top speed – 196 mph			
– Emissions – 50 State LEV2/ULEV			
<b>Continuously Variable Valve Timing Control System (CVTCS) on intake valves</b>	■	■	■
<b>Aluminum cylinder block with high-endurance/low-friction plasma-sprayed bores</b>	■	■	■
<b>Aluminum pistons</b>	■	■	■
<b>Nissan Direct Ignition System with iridium-tipped spark plugs</b>	■	■	■
<b>Electronic drive-by-wire throttle</b>	■	■	■
<b>Pressurized lubrication system with thermostatically controlled cooling and magnesium oil sump</b>	■	■	■
<b>Fully symmetrical dual intake and low back-pressure exhaust systems</b>	■	■	■
<b>Secondary air intake system to rapidly heat catalysts to peak cleaning efficiency</b>	■	■	■
<b>Special 50:50 coolant mix</b>	□ <sup>c</sup>		

Drivetrain	Premium	Black Edition	GT-R® NISMO®
<b>ATTESA E-TS® All-Wheel Drive (AWD) with patented independent rear-mounted transaxle integrating transmission, differential and AWD transfer case</b>	■	■	■
<b>Advanced Vehicle Dynamic Control (VDC) with three driver-selectable modes (Normal, R-Mode, Off)</b>	■	■	■
<b>Electronic Traction Control System (TCS)</b>	■	■	■

■ Standard

□ Optional

□<sup>AC</sup> Accessory

□<sup>P</sup> Part of Premium Interior Package

□<sup>C</sup> Part of Cold Weather Package

Drivetrain (continued)	Premium	Black Edition	GT-R® NISMO®
<b>Dual-clutch 6-speed transmission with three driver-selectable modes (Normal, R-Mode, Save)</b>	■	■	■
<b>Fully automatic shifting or full sequential manual control via steering column-mounted paddle shifters</b>	■	■	■
<b>Downshift Rev Matching</b>	■	■	■
<b>Predictive pre-shift control (in R-Mode) preselects the next gear change based on throttle position, vehicle speed, braking input and other information</b>	■	■	■
<b>Rigid, lightweight carbon-composite main driveshaft</b>	■	■	■
<b>High-performance 1.5-way mechanical limited-slip rear differential</b>	■	■	■
<b>Hill start assist</b>	■	■	■

Brakes	Premium	Black Edition	GT-R® NISMO®
<b>Nissan/Brembo® braking system – 4-wheel disc brakes, 15.4" front and 15.0" rear two-piece floating-rotors with diamond-pattern internal ventilation</b>	■	■	■
<b>Super-rigid 6-piston front/4-piston rear monoblock calipers with racecar-inspired 3-point radial mounting</b>	■	■	■
<b>4-wheel Anti-lock Braking System (ABS)</b>	■	■	■
<b>Electronic Brake force Distribution (EBD)</b>	■	■	■
<b>Additional front and rear brake cooling air ducts</b>			■

Suspension/Steering	Premium	Black Edition	GT-R® NISMO®
<b>Double-wishbone front suspension with aluminum arms</b>	■	■	■
<b>Multi-link rear suspension with aluminum arms</b>	■	■	■
<b>Rigid front and rear suspension subframes, assembled in high-precision jigs similar to a racecar, with 6-point mounting to body</b>	■	■	■
<b>Bilstein® DampTronic® suspension system with three driver-selectable modes (Normal, R-Mode, Comfort)</b>	■	■	■
<b>Track-tuned suspension</b>			■
<b>NISMO®-tuned suspension</b>			■
<b>Hollow front stabilizer bar</b>	■	■	■
<b>Solid rear stabilizer bar</b>	■	■	
<b>NISMO®-tuned 17.3 mm hollow rear stabilizer bar</b>			■
<b>Vehicle-speed-sensitive power steering</b>	■	■	■
<b>2.4 Steering-wheel turns lock-to-lock</b>	■	■	■

Wheels/Tires	Premium	Black Edition	GT-R® NISMO®
<b>Super-lightweight RAYS® forged-alloy wheels: 20" x 9.5" (front) 20" x 10.5" (rear)</b>	■		
<b>Special dark-finished super-lightweight RAYS® forged-alloy wheels: 20" x 9.5" (front) 20" x 10.5" (rear)</b>		■	
<b>NISMO® black super-lightweight RAYS® forged-alloy wheels: 20" x 10.0" (front) 20" x 10.5" (rear)</b>			■
<b>Exclusively developed tires,<sup>1</sup> nitrogen-filled at factory: 255/40ZRF20 (front) 285/35ZRF20 (rear)</b>	■	■	■
<b>Dunlop® SP Sport MAXX GT600 DSST CTT high-performance run-flat tires<sup>1</sup></b>	■	■	■
<b>Dunlop® SP Sport 7010 all-season run-flat tires</b>	□ <sup>c</sup>		

Chassis/Body	Premium	Black Edition	GT-R® NISMO®
<b>Premium Midship (PM) platform with hybrid unibody assembled using high-precision, ultra-low-tolerance jigs similar to racecar construction</b>	■	■	■
<b>Aluminum hood and outer door skins</b>	■	■	■
<b>Aluminum trunk lid</b>	■	■	
<b>Carbon-fiber trunk lid</b>			■
<b>Die-cast aluminum front shock towers and inner door structures</b>	■	■	■
<b>Carbon-fiber engine chassis brace</b>	■	■	■
<b>Carbon-composite front crossmember/radiator support</b>	■	■	■
<b>All outer body panels stamped using multiple-strike coining process for exceptional rigidity and precision</b>	■	■	■
<b>Increased rigidity to the body shell is achieved using adhesive bonding and spot welding</b>			■

Exterior Features	Premium	Black Edition	GT-R® NISMO®
<b>Aerodynamic undertrays</b>	■	■	■
<b>Front spoiler with carbon-fiber air ducts</b>			■
<b>Front fenders designed to optimize air management around the wheels</b>	■	■	
<b>Body-color rear spoiler</b>	■		
<b>Dry carbon-fiber rear spoiler<sup>2</sup></b>		■	
<b>NISMO® aerodynamic body design – carbon-fiber front and rear fascia, side sills and rear spoiler</b>			■
<b>Multi-LED headlights with signature lighting</b>	■	■	■
<b>Automatic on/off headlights</b>	■	■	■

<sup>1</sup>Always use appropriate tires for weather conditions. See Owner's Manual for details. Failure to use appropriate tires could cause an accident resulting in serious injury or death. <sup>2</sup>Dry carbon-fiber requires specific maintenance. Please see your Owner's Manual for details. <sup>3</sup>Required SiriusXM® Satellite Radio, NavTraffic® and NavWeather® subscriptions sold separately after trial period. Installation costs, one-time activation fee, other fees and taxes will apply. NavTraffic® available in select markets. Services available only to those 18 or older in the 48 contiguous states and D.C. Fees and programming subject to change. Subscriptions governed by Customer Agreement available at [siriusxm.com](http://siriusxm.com). ©2015 Sirius XM Radio Inc. Sirius® XM® and all related marks and logos are trademarks of Sirius XM Radio Inc. <sup>4</sup>Availability of specific features is dependent upon the phone's Bluetooth® support. Please refer to your phone Owner's Manual for details. Bluetooth® word mark and logos are owned by Bluetooth SIG, Inc., and any use of such marks by Nissan is under license. <sup>5</sup>Air bags are only a supplemental restraint system; always wear your seat belt. Even with the occupant-classification sensor, rear-facing child restraints should not be placed in the front-passenger's seat. All children 12 and under should ride in the rear seat properly secured in child restraints, booster seats, or seat belts according to their size. Air bags will only inflate in certain accidents; see your Owner's Manual for more details. <sup>6</sup>TPMS is not a substitute for regular tire pressure checks. Alcantara® is a registered trademark of Alcantara S.p.A. Corporation. Bilstein® and DampTronic are registered trademarks of ThyssenKrupp Bilstein GmbH. Bose® is a registered trademark of The Bose Corporation. Brembo® is a registered trademark of Freni Brembo S.p.A. Dunlop® is a registered trademark of DNA Ltd. Corporation. HomeLink® is a registered trademark of Gentex Corporation. iPod® is a registered trademark of Apple, Inc. All rights reserved. iPod not included. RAYS® is a registered trademark of RAYS Engineering. Recaro® is a registered trademark of Recaro North America Inc.



SPECIFICATIONS (CONTINUED)

Exterior Features (continued)	Premium	Black Edition	GT-R® NISMO®
LED Daytime Running Lights and LED taillights	■	■	■
Dual power folding heated outside mirrors	■	■	■
Flush-mounted aluminum door handles	■	■	■
Quad 5" polished exhaust finishers	■	■	
Titanium exhaust with polished exhaust finishers			□
UV-reducing solar glass	■	■	■

Comfort/Convenience	Premium	Black Edition	GT-R® NISMO®
Nissan Hard Drive Navigation System with 7.0" VGA touch-screen monitor and voice recognition	■	■	■
NavTraffic® and NavWeather® provided by SiriusXM®	■	■	■
Driver-configurable Multi-Function Display system with graphical readouts of vehicle data and driving data displayed on a total of six screens	■	■	■
RearView Monitor	■	■	■
Nissan Intelligent Key® with Push Button Ignition	■	■	■
Electronic analog instrument cluster with upshift indicator, vehicle information display and digital gear indicator	■	■	■
NISMO® tachometer			■
Bluetooth® Hands-free Phone System <sup>4</sup>	■	■	■
HomeLink® Universal Transceiver	■	■	■
Dual Zone Automatic Temperature Control (ATC)	■	■	■
In-cabin microfilter	■	■	■
Power front windows with one-touch auto-up/down	■	■	■
Power door locks with auto-locking feature	■	■	■
Cruise control with steering wheel-mounted controls	■	■	■
Tilt/telescoping steering column with integrated gauges	■	■	■
Variable intermittent flat-blade speed-sensitive windshield wipers	■	■	■
Sun visors with illuminated vanity mirrors	■	■	■
Overhead sunglasses storage	■	■	■
Map lights	■	■	■
Auto-dimming inside rearview mirror	■	■	■
12-volt DC power outlets (2)	■	■	■
Lockable glove compartment	■	■	■
Front door pockets	■	■	■
Cup holders (2 front, 1 rear)	■	■	■

Seating/Appointments	Premium	Black Edition	GT-R® NISMO®
Leather-appointed front seats with synthetic suede inserts	■		
Hand-stitched semi-aniline leather-appointed seats	P		
Black/Red Recaro® leather-appointed front seats		■	
NISMO® Recaro® leather-appointed front seats with synthetic-suede inserts			■
8-way power driver's seat	■	■	■
4-way power front passenger's seat with entry/exit switch for rear passenger	■	■	■
Heated front seats	■	■	■
Hand-stitched semi-aniline leather interior treatments	P		
Black/Red interior treatment		■	
NISMO® Black/Red interior treatment			■
Leather-wrapped steering wheel	■	■	
NISMO® Alcantara®-wrapped steering wheel and gauge hood			■
Leather-wrapped magnesium paddle shifters	■	■	■
Leather-wrapped gearshift knob	■	■	■
Carbon-fiber and charcoal brushed-metal interior trim	■	■	■
Aluminum-trimmed pedals	■	■	■
GT-R® carpeted floor mats	AC	AC	AC

Audio/Entertainment	Premium	Black Edition	GT-R® NISMO®
Bose® audio system with Active Noise Cancellation (ANC)	■	■	■
11 speakers, including dual subwoofers	■	■	■
MP3/WMA CD and DVD video playback capability	■	■	■
SiriusXM® Satellite Radio <sup>3</sup>	■	■	■
USB connection port for iPod® interface and other compatible devices	■	■	■
Streaming audio via Bluetooth® wireless technology <sup>4</sup>	■	■	■
Steering wheel-mounted audio controls	■	■	■
Speed-sensitive volume control	■	■	■

Safety/Security	Premium	Black Edition	GT-R® NISMO®
Nissan Advanced Air Bag System with dual-stage supplemental front air bags with seat belt and occupant-classification sensors <sup>5</sup>	■	■	■
Driver and front-passenger side-impact supplemental air bags <sup>5</sup>	■	■	■

Safety/Security (continued)	Premium	Black Edition	GT-R® NISMO®
Roof-mounted curtain side-impact supplemental air bags for front occupant head protection <sup>5</sup>	■	■	■
Front seat belts with pretensioners and load limiters	■	■	■
LATCH System (Lower Anchors and Tethers for CHildren)	■	■	■
Zone Body construction with front and rear crumple zones	■	■	■
Hood-buckling creases and energy-absorbing steering column	■	■	■
Tire Pressure Monitoring System (TPMS) with individual tire pressure display <sup>6</sup>	■	■	■
Nissan Vehicle Immobilizer System	■	■	■
Vehicle Security System	■	■	■

PACKAGES

P Premium Interior Package
Hand-stitched semi-aniline leather-appointed seats
Hand-stitched semi-aniline leather interior treatments

C Cold Weather Package
Dunlop® SP Sport 7010 all-season run-flat tires <sup>1</sup>
Special 50:50 coolant mix



## DIMENSIONS/CAPACITIES

### Dimensions – Inches

#### Exterior

Wheelbase	109.4
Overall length	183.9; 184.3 GT-R® NISMO®
Overall width	74.6
Overall height	53.9; 53.9 GT-R® NISMO®
Track width (front/rear)	62.6/63.0; 63.0/63.0 GT-R® NISMO®

#### Aerodynamics – Cd

Drag coefficient	0.26
------------------	------

#### Interior (front/rear)

Head room	38.1/33.5	Hip room	54.7/44.9
Leg room	44.6/26.4	Shoulder room	54.3/50.0

### Capacities

Interior passenger volume (cu. ft.)	79.0
Cargo volume (cu. ft.)	8.8
Fuel tank (gals.)	19.5

### Curb Weights – Lbs.

	Premium	Black Edition	GT-R® NISMO®
Base total	3,922	3,904	3,885
Weight distribution	54/46	54/46	54/46

### 2016 EPA Fuel Economy Estimates

City/highway/combined MPG	16/23/19
---------------------------	----------

Actual mileage may vary with driving conditions – use for comparison only.



Up to 74.6"



Up to 183.9"



53.9"

## BUYING/OWNING



**Nissan Motor Acceptance Corporation.** Whether you're buying or leasing, you'll find attractive rates and flexible terms to make your purchase more accessible.

**College Grad Program.** Ask about our special new vehicle pricing available to individuals up to two years after graduation.

**Active and Reserve US Military Program.** Ask about eligibility for our fixed discount on new vehicle pricing available to those serving our country.

**New Vehicle Limited Warranties.** Protection for your new Nissan includes 3-year/36,000-mile (whichever occurs first) basic coverage and 5-year/60,000-mile (whichever occurs first) powertrain coverage. Terms, conditions and exclusions apply. See Warranty Information Booklet for complete details.

**Security+Plus®** For additional peace of mind, a variety of extended service plans lets you tailor the coverage to your driving habits.

**Maintenance+Plus®** This extended plan ensures your Nissan will receive up to 17 different services and over 33 different inspection items at each visit, using the most up-to-date diagnostic equipment available.

**Genuine Nissan Parts.** When it comes time for service, any necessary replacement parts will be made using Genuine Nissan new or remanufactured parts, or Nissan-approved parts. And they're the only parts to carry Nissan's factory-backed limited warranty.

**Nissan Mobility Assist.** This program offers reimbursements toward the purchase and installation of certain mobility assistance products for program-eligible Nissans. Go to [NissanUSA.com/mobility](http://NissanUSA.com/mobility) for more info.

### Thumbs Off Your Phone While Driving!

Every year, too many people die because we can't put our phones down while driving. That's why Nissan is supporting the Red Thumb Movement as part of our ongoing commitment to reduce fatalities on the road. So paint your thumbnail red as a reminder not to pick up your phone when you're behind the wheel. Find out more at [NissanUSA.com/redthumb](http://NissanUSA.com/redthumb)



Follow us: [@NissanSupport](https://twitter.com/NissanSupport)

At [NissanUSA.com](http://NissanUSA.com), you'll find virtual product demonstrations, a way to "build your own Nissan," a dealer locator, and more information about key Nissan support services. Or if you'd prefer, call **1-800-NISSAN-3** for answers to specific questions about GT-R® or any other Nissan vehicle. The Nissan names, logos, product names, feature names, and slogans are trademarks owned by or licensed to Nissan Motor Co. Ltd. and/or its North American subsidiaries. Other trademarks and trade names are those of their respective owners. **Always wear your seat belt, and please don't drink and drive.** ©2015 Nissan North America, Inc.

This brochure is intended for general descriptive and informational purposes only. It is subject to change and does not constitute an offer, representation or warranty (express or implied) by Nissan North America, Inc. Interested parties should confirm the accuracy of any information in this brochure as it relates to a vehicle directly with Nissan North America, Inc., before relying on it to make a purchase decision. Nissan North America, Inc., reserves the right to make changes, at any time, without prior notice, in prices, colors, materials, equipment, specifications, and models and to discontinue models or equipment. Due to continuous product development and other pre- and post-production factors, actual vehicle, materials and specifications may vary from this brochure. Some vehicles shown with optional equipment. See the actual vehicle for complete accuracy. Availability and delivery times for particular models or equipment may vary. Specifications, options and accessories may differ in Hawaii, U.S. territories and other countries. For additional information on availability, options or accessories, see your Nissan dealer or contact Nissan North America, Inc.

CLICK  
HERE

Sign up for the latest news and updates on  
the 2016 Nissan GT-R®

or visit [NissanUSA.com/gt-r](http://NissanUSA.com/gt-r)

Los folletos de Nissan también están disponibles en español.

Para descargar el PDF, visita:

[NissanUSA.com/folletos-espanol](http://NissanUSA.com/folletos-espanol)

And follow Nissan on:

