

2001

ACURA

CL



ALL ACURA AUTOMOBILES ARE UNIQUELY DESIGNED TO COMBINE EXHILARATING PERFORMANCE AND PRECISE HANDLING WITH ELEGANCE, COMFORT AND A HIGH LEVEL OF REFINEMENT. IN EVERY SENSE, FROM THEIR LAVISH LIST OF STANDARD LUXURY FEATURES TO THEIR TECHNOLOGICALLY ADVANCED ENGINES AND SUSPENSIONS, ACURA VEHICLES HAVE BEEN CAREFULLY CRAFTED TO PROVIDE A STIMULATING DRIVING EXPERIENCE. IN FACT, ALL ACURA VEHICLES HAVE WHAT MIGHT BE CALLED AN IDEAL BALANCE OF PERFORMANCE AND COMFORT. THE NEW 2001 3.2CL AND CL TYPE S ENHANCE THAT TRADITION AND ELABORATE ON IT WITH SPORTS CAR-LIKE HANDLING AND IMPRESSIVE LUXURY.

CLEAR YOUR SCHEDULE.



7 ENGINE

9 SUSPENSION

10 INTERIOR

16 NAVIGATION

18 MUSIC SYSTEM

20 SAFETY

26 CUSTOMER SATISFACTION

28 ACCESSORIES

29 SPECIFICATIONS

TELL THEM SOMETHING BIG JUST CAME UP.





Acura CL Type S shown in Satin Silver Metallic.



INTRODUCING THE ALL-NEW 2001 ACURA CL.



HIGH POWER, RESPONSIBLE

POWER TO ENERGIZE YOUR SOUL.

All Acura engines have achieved an enviable reputation for smoothness, high efficiency per liter of displacement and impressive reliability. The CL enhances that tradition. It features a 3.2-liter, SOHC, 4-valve-per-cylinder engine equipped with the Variable Valve Timing and Lift Electronic Control (VTEC) system. This engine also features the PGM-FI system for precise fuel metering, a direct ignition system for a hotter, more stable spark and a low-restriction exhaust system to reduce back-pressure and promote better breathing. In the CL, the engine produces 225 hp, while the CL Type S produces an impressive 260 hp, thanks to an advanced 2-stage intake manifold and a higher compression ratio. This unique manifold design uses advanced tuning technology to provide the combustion chamber with a larger dose of the fuel/air mixture during the intake stroke. This higher efficiency produces more torque at low and medium engine speeds for better off-the-line response, and greater power at high engine speeds for better response when passing.

First developed for the NSX, the CL's VTEC system employs a unique 3-lobe cam design and uses oil pressure and electronic controls to alter valve timing and lift to boost low-end torque and high-end horsepower.

To achieve the CL's extremely low emissions, the exhaust system features a high-performance catalytic converter system that utilizes a precious metal within its high-flow honeycomb structure. This promotes quicker warm-up of the catalytic element to reduce pollutants, especially under cold-start situations. Stainless steel construction resists corrosion to boost the durability of the exhaust components, and in the CL Type S a newly developed spin-casting cylinder-liner technique enhances engine durability and also reduces weight to promote greater overall efficiency.

LOW EMISSIONS

The engine isn't just refined, it also produces very low levels of emissions. The California-spec CL is classified as an Ultra-Low Emission Vehicle (ULEV), while the CL Type S is classified as a Low-Emission Vehicle (LEV).

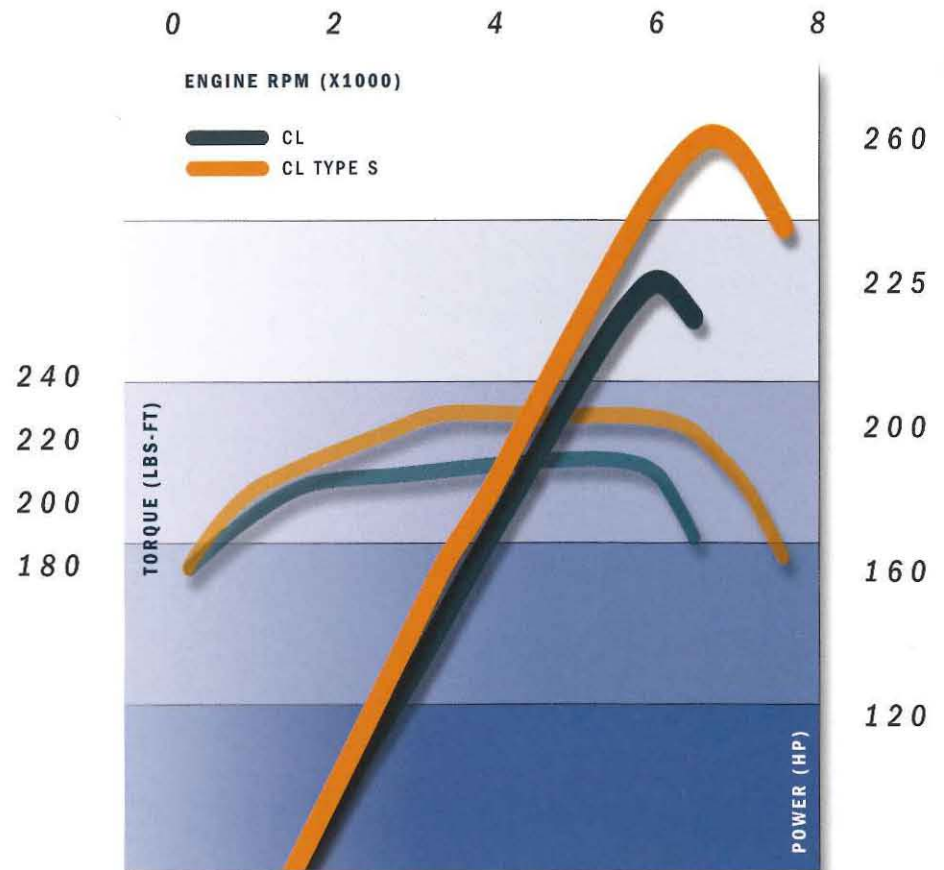

POWER AND TORQUE

With VTEC, 24 valves and a host of other innovations, the CL produces 225 hp and 216 lbs-ft of torque. With a higher compression ratio and high-flow induction, the CL Type S produces 260 hp and 232 lbs-ft of torque.

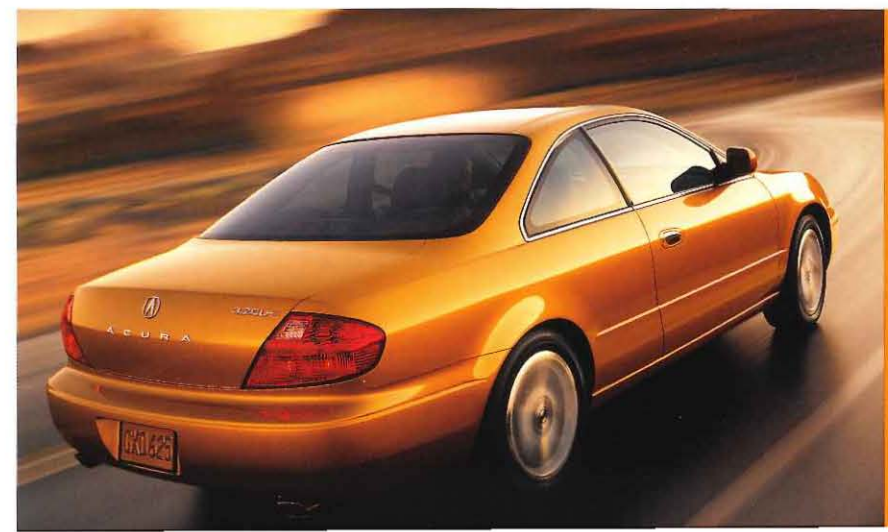



SMOOTH, REFINED AND RESPONSIVE. The CL is equipped with an advanced 5-speed, electronically controlled automatic transmission. Adapting the use of a fifth gear, normally found only in manual transmissions, allowed the engineers to create closer gear ratios for the four lower gears to enhance performance.

To make the most of these performance-enhancing gear ratios, the CL features the Sequential SportShift system. Derived from Formula One racing technology, this transmission system allows the driver to manually shift gears by a flick of the shift lever. This gives a sports-oriented driver the responsiveness of a manual transmission with the convenience of a full automatic.

The transmission is also equipped with our unique Grade Logic Control System. Using advanced computer controls, this system eliminates the annoying "gear hunting" normally encountered when driving up and down steep hills. The Grade Logic system selects and holds the proper gear for the vehicle speed and steepness of the pavement to provide a smoother, less intrusive drive.

In addition to providing a high level of driveability, the CL transmission has a newly designed lubrication system that reduces internal friction losses and a lockup torque converter system that reduces slippage and enhances fuel economy.* The combination of a silky-smooth engine and sophisticated transmission creates an exceptionally responsive powertrain that is perfectly suited to daily urban driving as well as exhilarating open-road performance.

*See specifications page for EPA-estimated-mileage information.

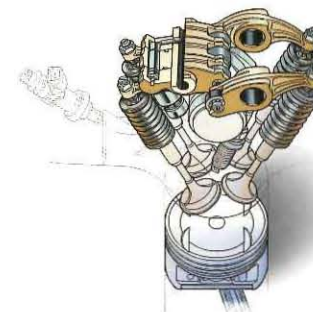

VARIABLE TIMING AND LIFT

The Variable Valve Timing and Lift Electronic Control (VTEC) system employs a unique 3-rocker overhead cam design that alters valve lift and valve timing to boost low-end torque and high-end power.

5-LINK REAR SUSPENSION

The multi-link double-wishbone rear suspension system is equipped with a unique pillow-joint design to better resist toe-change under cornering loads. This enhances directional stability to allow the CL to track more precisely.

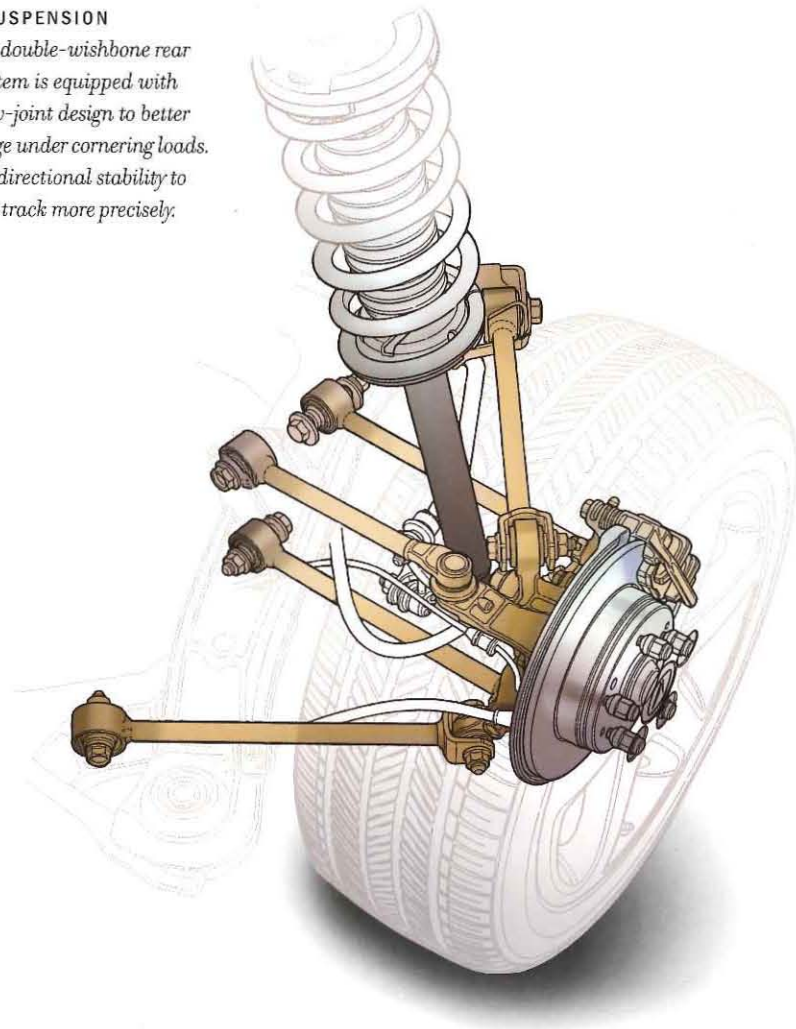

RIDE, HANDLING AND CRISP RESPONSE. Like all Acura vehicles, the CL is equipped with independent front and rear double-wishbone suspension, a system similar to that found in Formula One race cars. It's been proven to be one of the most sophisticated suspensions ever designed and is ideal for providing the perfect balance of handling and ride quality.

A further refinement is the use of a fifth rear suspension link that enhances directional control for improved stability under cornering and when driving over bumps. In addition to the double-wishbone design, the suspension also features a coil-over shock absorber at each wheel and stabilizer bars at the front and rear.

To meet the spirited handling goals, both models are equipped with aluminum-alloy wheels, 16 x 6.5 on the CL and 17 x 7 for the Type S. To provide the ideal balance of ride comfort, adhesion and predictable behavior, the CL features 205/60 R16 91V all-season tires, while the higher performance Type S is equipped with wider, lower profile, more aggressive 215/50 R17 93V all-season tires.

To provide excellent isolation from road noise and rumble, the front and rear suspensions are mounted on separate subframes. These subframes are in turn connected to the chassis through the use of tuned rubber isolators that effectively dampen undesirable vibration and harshness, keeping them out of the passenger cabin.

In terms of suspension refinement, chassis rigidity, handling precision and ride quality, the CL is about as close as you can come to a perfect performance coupe.

ANTI-LOCK BRAKING SYSTEM

The CL is equipped with a 4-wheel disc Anti-Lock Braking System (ABS) that modulates brake-line pressure to prevent lockup and allows the driver to maintain steering control under maximum braking effort.

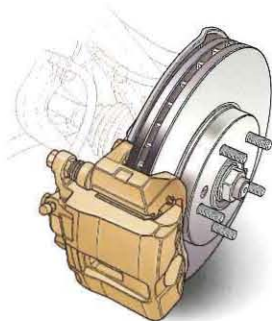

RIGID STRUCTURE

The CL's rigid chassis benefits from structural reinforcements in critical areas to increase resistance to bending and torsional forces. This improves handling precision as well as impact protection in a collision.

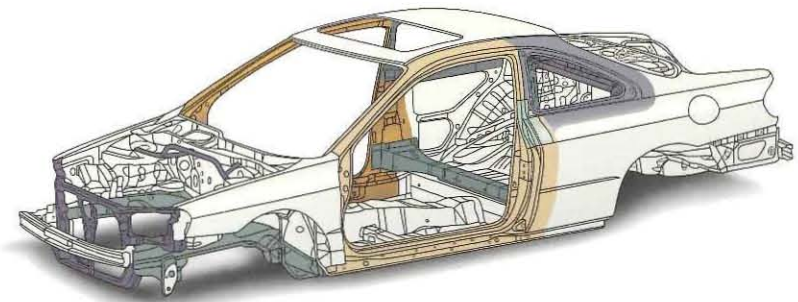



REAR CENTER ARMREST

The fold-down rear center armrest provides two built-in beverage holders. Beneath the armrest is a large console that features ample storage for essentials such as glasses and maps.

FULLY FURNISHED PERFORMANCE. The CL's interior is a finely tuned and perfectly proportioned space that's luxuriously equipped but also intelligently crafted to be functional. Call it luxury with purpose.

Like the best racing seats, the CL's seats are designed to hold you in place in cornering and transient maneuvers. Unlike racing seats, however, the CL seats are precisely tailored and designed to be comfortable, even after you spend hours and hours behind the wheel. To add a level of elegance, they're also trimmed in glove-soft leather and offer all the adjustments you would expect in a luxury car.

The CL has an 8-way power driver's seat adjustment with two-driver memory function, while the passenger seat has 4-way power adjustment. The CL also features a power walk-in rear-seat feature that automatically advances the seat to allow easier entry into the rear-seat area. A memory feature returns the seat to its original position, but will automatically stop if it encounters an obstruction.

The analog instruments are patterned after classic Grand Touring cars. They're large and clearly visible through the upper arc of the thick, leather-trimmed steering wheel. Unlike those venerable Europeans, however, the CL has one of the most powerful air-conditioning systems on the market. It also has one of the quickest cool-down rates in its class. A micron filter helps to keep out dust and pollen particles down to one millionth of a meter. And when air conditioning isn't absolutely necessary, the standard power-operated moonroof will provide plenty of fresh air.



THE CLASSIC GAUGE STYLE

In the tradition of the classic European GT machines, the CL Type S is equipped with metallic gauge faces and black numerals. At night, the faces darken and the numbers are illuminated.



8-WAY ADJUSTABLE SEAT

The 8-way power driver's seat is deeply bolstered and trimmed with hand-selected leather for a great seating position, no matter how long or spirited the drive may be.

A PERFECT ENVIRONMENT IN WHICH TO GET LOST.



Acura CL Type S interior shown with Ebony Leather and available Acura Satellite-Linked Navigation System.



Acura CL Type S interior shown with Ebony Leather and available Acura Satellite-Linked Navigation System.





Acura CL Type S shown in Nighthawk Black Pearl.



YOUR ON-BOARD CO-PILOT.



- MENU
- MAP/GUIDE
- A/C
- CANCEL
- IN ZOOM OUT



PUSH TO SELECT

ACURA NAVIGATION SYSTEM

ANTI-THEFT

- REAR
- Wiper icon
- Car icon
- 72
- TEMP
- OFF
- AUTO

6-COMPACT DISC CHANGER





STEP-BY-STEP DIRECTIONS

The Acura Satellite-Linked Navigation System pinpoints your location, gives you voice prompts and directs you to your destination. The system is menu-driven for clarity and ease of operation.

YES, IT IS ROCKET SCIENCE. The latest generation of the in-dash, Acura Satellite-Linked Navigation System* is perhaps the most advanced system of its kind on the market. This critically acclaimed technology uses input from orbiting Global Positioning Satellites and combines it with information from the on-board inertial guidance system to pinpoint your location. The mapping database is stored on a single DVD that contains route information for the entire United States. Updating the stored information to reflect the most recent changes and additions is simple. You can purchase an updated DVD and install it yourself.

When you input your destination, the system will give you clear voice prompts and visual indications to guide you. In addition to helping you find the most direct route, the DVD also stores additional vital information. You can call on it to help you find a local airport, a restaurant, service station, or the nearest ATM. In fact, there are over 3.7 million points of interest stored on the DVD. So if you're far from home and need to find a place to eat or some cash for your immediate requirements, the Acura Satellite-Linked Navigation System is always on the job and ready to help.

What if you don't know where you're going and only have a phone number for your destination? The system has the capability to handle that little problem for you. Just enter the phone number. If the number is in the database, the system will find the address and then show you how to get there with visual and audio cues.

In addition to all this, the system also provides you with important information that can speed you on your trip. You can call up the estimated distance and travel time to your destination and the total elapsed time of your trip. You can even tailor the route to your personal preferences. If, for instance, you want to avoid freeways, the navigation system gives you the option of selecting a street-only route. And what if the suggested route becomes unusable? That's not a problem either. If you diverge from the suggested course due to a traffic obstruction, the system can suggest an alternate route. It's always one step ahead of you.

*See your local Acura dealer for navigation system area coverage.

GLOBAL SATELLITES

The Acura Satellite-Linked Navigation System uses information provided by orbiting Global Positioning Satellites. It uses this data to pinpoint your location and help guide you to any destination in the United States.

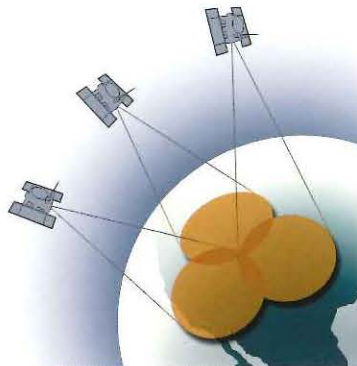

COAST-TO-COAST COVERAGE

With 4.7 gigabytes of information on the DVD, the navigation system will help you find your way even if you're traveling far from home. The bright touch-screen display and menu-driven operating system make it easy to retrieve the information you need.





PRECISELY TUNED SOUND SYSTEM. *The Acura/Bose® Music System is without question one of the most sophisticated music systems available. In many ways, it's superior to even high-end home music systems because the system is tailored specifically for the unique acoustic signature of the CL interior, something that can't be said for most home music systems.*

Audio engineers analyzed such factors as the location of the occupants, the type of fabric and the trim materials and also took into account the nature and volume of road and wind noise. Armed with over 1,000 separate measurements, the engineers then carefully calibrated the music system to overcome these factors.

The result is a powerful system with six strategically located speakers driven by a state-of-the-art amplifier. The system uses 1.5-inch tweeter speakers located at the base of each A-pillar, while the 6.5-inch woofers are located at foot level on the doors. The 6x9-inch coaxial speakers, which contain both woofers and tweeters, are located on the rear parcel shelf. This array surrounds you with rich, acoustically faithful sound.

The head unit is a combination AM/FM tuner with cassette and a CD player. Unlike some CD players that require a separate, remotely located CD cartridge, this system lets you load up to six CDs directly into the dash-mounted unit. The in-dash 6-CD capability makes it easy to program many hours of music, or to change discs right from the front seat without needing to stop and load a separate CD cartridge.

Adding to the convenience of the music system are the steering wheel-mounted audio controls that let you adjust the audio volume, change radio stations and even select CD tracks without lifting a hand from the steering wheel.

AUDIO CONTROLS

Steering wheel-mounted audio controls allow the driver to adjust volume, change stations or select a favorite track from a CD. This adds a measure of safety by keeping the driver's eyes on the road and hands on the steering wheel.



BOSE 6-SPEAKER SYSTEM

The CL audio system was precisely calibrated by Bose engineers to match the unique acoustic signature of the interior. This six-speaker configuration surrounds the occupants with rich sound that you can feel as well as hear.

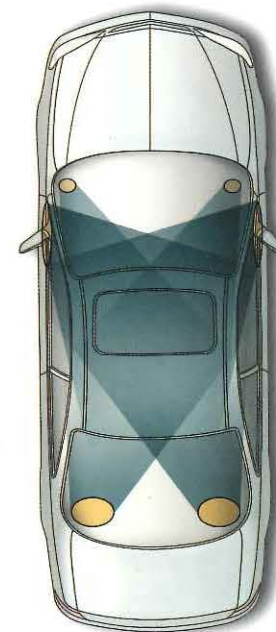

77

TEMP

OFF AUTO

6-COMPACT DISC CHANGER

LOAD



(1)	2	3	CD	105
4	5	6		DISC TRACK



VOL PUSH PWR
RPT / RDM
SCAN/A.SEL



ACURA BOSE

ANTI THEFT

AM

FM

CD

TAPE

-TUNE +
PUSH MODE
SEEK/SKIP



PLAY
1

PROG
2

REW
3

FF
4

5

6

THE LEATHER-LINED CONCERT HALL.

VEHICLE STABILITY ASSIST

The finely tuned suspension system of the Type S is enhanced by the Vehicle Stability Assist (VSA) system. When cornering, this technology can detect an impending oversteer or understeer condition and apply braking to the appropriate wheel(s) and/or modulate the throttle to help bring the vehicle back to the intended path. This advanced system offers a new level of handling stability and confidence, especially in adverse conditions.

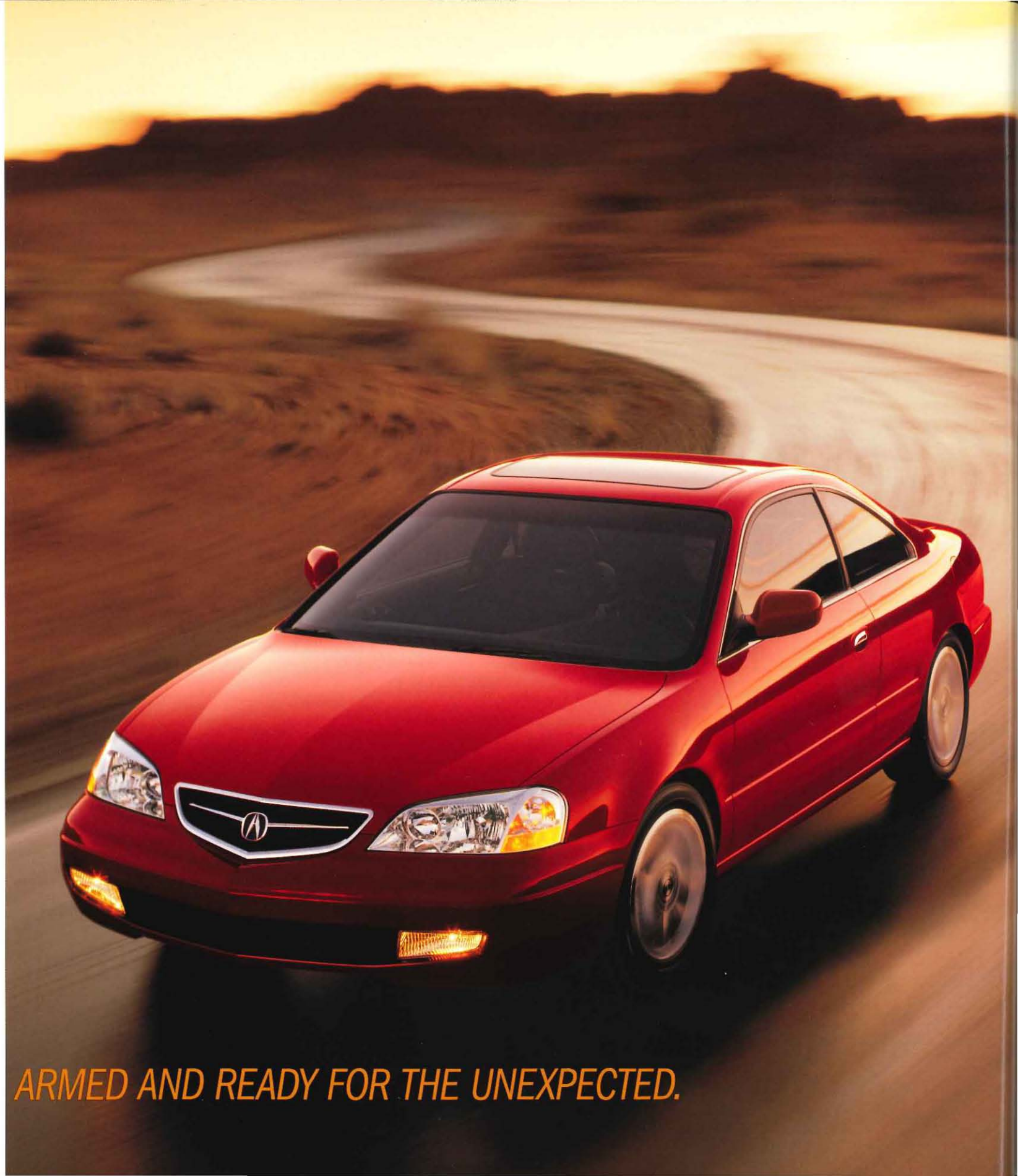

ARMED AND READY FOR THE UNEXPECTED.

MULTI-LAYERED SAFETY SYSTEM. Safety and occupant protection have

always been top priorities at Acura, so we've pioneered a number of innovations. The CL benefits from the accumulated knowledge of years of safety engineering.

The heart of the CL's occupant-protection technology is its rigid chassis designed by the most advanced Finite Element Modeling and Stress Analysis computer software. The computer models were then put through rigorous real-life testing and verification. The net result is a steel-reinforced passenger cabin with front and rear crumple zones that are designed to help dissipate impact energy while helping to maintain the structural integrity of the passenger compartment.

For this system to work correctly, the occupants need to be properly restrained. The primary restraint device is the 3-point seat-belt system that works in concert with the front air bag Supplemental Restraint System (SRS)* and side air bags. The safety belts in the CL provide additional restraint through the use of the pretensioner system that uses devices, similar to those used to deploy the air bags, to snugly tighten the belts upon impact, helping hold the occupants in place.

The side air-bag occupant sensor, located in the passenger seatback, detects the size and position of the front passenger to prevent the bags from deploying in a moderate-to-severe impact if a child or small adult is out of position, such as leaning against the door. The dual-stage front passenger's front air bag uses technology that senses the severity of a collision and deploys the air bag accordingly. This multi-layered approach is evidence of Acura's ongoing commitment to occupant safety.

*Acura reminds you and your passengers to fasten your seat belts.

A SIDE-IMPACT DOOR BEAMS

The door beams are designed to work like the crumple zones. In a side impact, they help minimize intrusion into the cabin and help reduce injury to the occupants.

B XENON HID HEADLIGHTS

High-Intensity Discharge (HID) headlights throw a longer, wider, more focused beam.

C MID-FLOOR GUSSET

The sturdy mid-floor gusset reinforcement member was developed to more effectively resist side-impact intrusion into the cabin.

D 5-MPH BUMPERS

The front and rear bumpers can absorb impact energy of up to five miles per hour without damage to the vehicle.

E SIDE FRAME-END STIFFENER

A side frame-end stiffener enhances the integrity of the cabin safety cell.

F PARCEL SHELF SUPPORT

A new support member ties the rear parcel shelf more securely to the rear bulkhead and rear wheelwells. This boosts rigidity for better protection and also helps to reduce road noise and vibration.



DUAL DOOR BEAMS

The dual door beams provide intrusion protection in a side impact. The system is designed to help absorb and dissipate impact energy and, working in concert with the side air bags, helps provide an added layer of protection.



CHILD-SEAT TETHER ANCHORS

The CL has strong child safety-seat anchors located on the rear parcel shelf. These anchors should be used in accordance with the instructions for the child seat to provide an additional level of occupant protection.



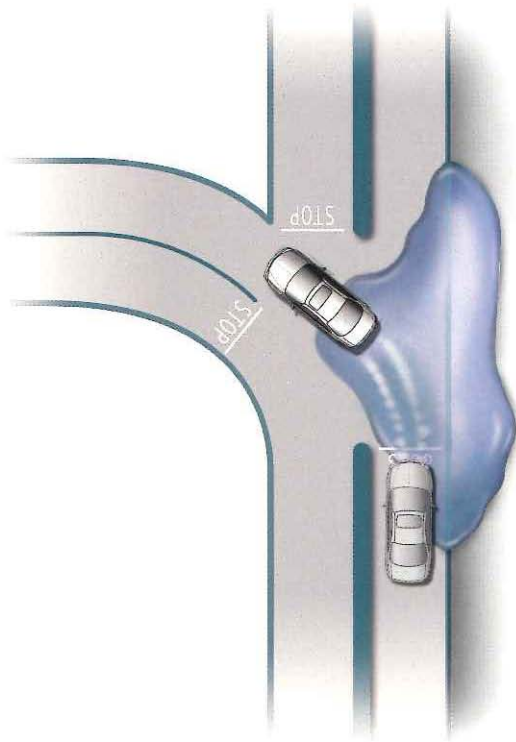

TRACTION CONTROL SYSTEM

The Traction Control System (TCS) is designed to help the driver retain steering control by preventing wheelspin under acceleration on ice, snow or a slippery surface. Using the sensors from the ABS system, the TCS will detect wheelspin and reduce throttle. If this isn't sufficient to reduce wheelspin, the system will then apply the brakes to the spinning wheel(s) until traction is regained.

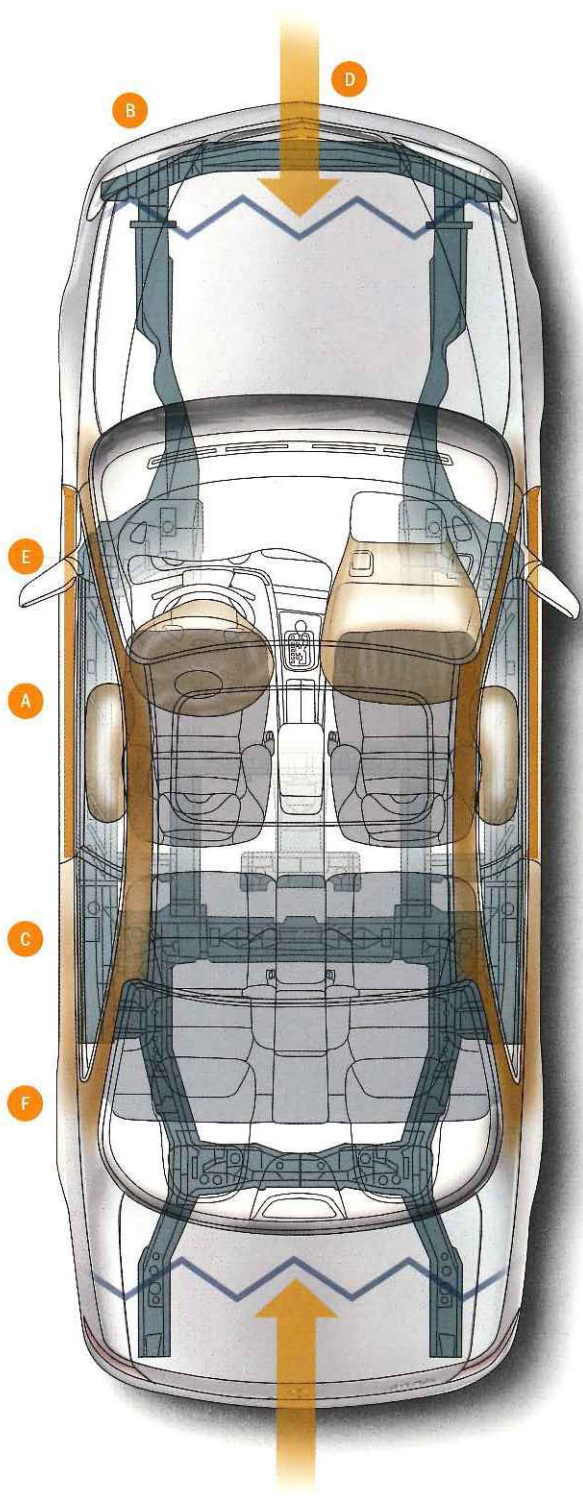



Acura CL shown in Dark Emerald Pearl.



WE'RE NOT SATISFIED UNTIL YOU ARE.



Left to right: NSX-T, Integra, 3.2CL, 3.2TL and 3.5RL.

SUPPORT FROM ACURA PROFESSIONALS. Acura's commitment to your satisfaction doesn't end with delivery of a world-class automobile. It only begins there. We've developed a broad range of services designed to help you enjoy your new vehicle and provide assistance should you need it. First and foremost, every new Acura vehicle is covered by a 4-year/50,000-mile limited warranty.* Additional peace of mind is available with the Acura Care Program that provides additional service and repair coverage beyond that provided by the initial warranty period.

The centerpiece of Acura's commitment is the Total Luxury Care (TLC) program. This service is provided at no additional charge with every new Acura and offers a range of benefits that includes 24-hour Roadside Assistance, computerized Trip-Routing Service and special Concierge Service. This package of benefits makes owning an Acura as pleasurable as driving one.

*See your local Acura dealer for warranty details.



Acura Care provides service coverage beyond the initial warranty period. Among other benefits, this package of services includes 24-hour Roadside Assistance. Consult your local Acura dealer for complete details.



Every new Acura vehicle comes with a little something extra — the Total Luxury Care program. This impressive package of benefits and services is created to make every day with your Acura as trouble-free and pleasant as possible.



CUSTOMER SATISFACTION

Your selection of an Acura product is deeply appreciated by your local dealer. If you have questions on maintenance or just want to express an opinion, your dealer is always ready to help.



24-HOUR ROADSIDE ASSISTANCE

This service is available everywhere in the United States, day or night, every day of the year. Just call the toll-free number and assistance is on its way.

24-HOUR EMERGENCY TOWING

If you encounter a mechanical problem, we'll send a tow truck and bring your Acura to the nearest service facility.

ACURA CONCIERGE SERVICE

If you need to reserve a hotel room or need help planning a tour, the Concierge Service is ready to help.

TRIP-INTERRUPTION BENEFITS AND EXPENSE REIMBURSEMENT

If a problem that is covered by your warranty interrupts your trip, Acura will reimburse you for any reasonable additional expense you might incur.

COMPUTERIZED TRIP-ROUTING

If you're driving across the country, or just across the state, we've got a huge database that will help you find the most direct route to your destination.

VEHICLE-LOCKOUT SERVICE

In case you lock yourself out, we can send help to unlock your vehicle or speed you a replacement key.

See your dealer for details about the privileges of ownership, which include Total Luxury Care (TLC), Concierge Service and Acura Roadside Assistance.

PERSONALIZE YOUR CL.

MAKE IT JUST YOURS. Acura accessories will add that final personal touch to make your Acura uniquely yours and add another level of enjoyment. All Acura accessories have been designed and engineered specifically for your vehicle. Unlike some aftermarket accessories, Acura accessories fit and function perfectly because they were made only for Acura vehicles. Which means you can have them installed with complete peace of mind, knowing that your warranty will remain in full effect.

Your Acura dealer offers the complete line of Acura accessories in stock and can install them prior to taking delivery. You can even add the cost of accessories to the price of the vehicle and include them in the financing plan for convenience and ease of payment. Keep your CL genuine with Acura accessories.

REAR SPOILER

The body-colored rear spoiler adds a sporty look to your CL. It was designed specifically for the CL, so you know you'll get a perfect fit, flawless function and all the durability you've come to expect from an Acura product.

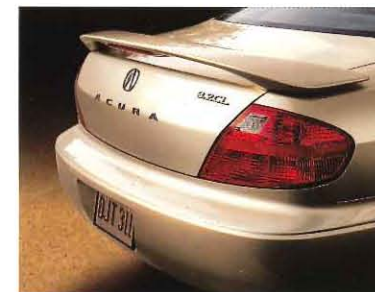

ALUMINUM-ALLOY WHEELS

To make your CL stand out from the crowd, you can choose these lightweight cast-aluminum-alloy wheels. They'll add a high-performance look and a touch of excitement to your CL.

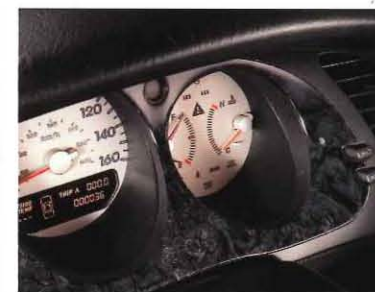

BLACK WOOD

The available Black Wood instrument panel gives your CL Type S an additional touch of class. Because it was designed specifically for the CL, it fits perfectly and coordinates precisely with the rest of your CL's interior.

EXTERIOR FEATURES

	CL	TYPE S
Power Moonroof w/Tilt Feature and Sliding Shade	•	•
Heated Power-Operated Outside Mirrors	•	•
Security System w/Remote Entry and Immobilizer	•	•
Xenon High-Intensity Discharge (HID) Headlights	•	•
Alloy Wheels	•	•
Integrated Rear Window Antenna	•	•
Dual-Outlet Exhaust	•	•
5-mph Bumpers (front/rear)	•	•

INTERIOR FEATURES

Leather-Trimmed Seats and Door Panel Inserts	•	•
Leather-Wrapped Steering Wheel	•	•
Sport Seats with Perforated-Leather Trim Interior	•	•
Driver's 8-Way Power Seat with Memory	•	•
Driver's Seat Adjustable Lumbar Support	•	•
Front Passenger's 4-Way Power Seat	•	•
Driver's Seat and Mirrors Memory System with Passenger's Side Reverse Gear Tilt-Down Feature	•	•
Simulated Wood-Grain Trim	•	•
Heated Front Seats	•	•
Power Walk-In Rear Seat Access	•	•
Power Windows w/Auto-Down Driver's Window	•	•
Power Door Locks	•	•
Cruise Control with Steering Wheel-Mounted Controls	•	•
Automatic Climate Control w/Micron Air Filtration	•	•
Acura/Bose® Music System w/Cassette and In-Dash 6-Disc CD Changer	•	•
Steering Wheel-Mounted Audio Controls	•	•
Auto-Dimming Interior Rearview Mirror	•	•
HomeLink® Remote System	•	•
Center Console Armrest with Storage Compartments	•	•
Metallic Sport Gauges	•	•
Floor Mats (front/rear)	•	•
Audio Anti-Theft Feature	•	•



SAFETY FEATURES

	CL	TYPE S
Driver's and Front Passenger's Air Bag Supplemental Restraint System (SRS)	•	•
Driver's and Front Passenger's Side Air Bags with Front Passenger's Height and Position Sensors	•	•
Seat Belts with Load Limiters and Pretensioners (front)	•	•
3-Point Seat Belts (front/rear)	•	•
Rear Child Safety-Seat Tether Anchors	•	•
4-Wheel Anti-Lock Braking System (ABS)	•	•
Traction Control System (TCS)	•	•
Vehicle Stability Assist (VSA)	•	•
Xenon High-Intensity Discharge (HID) Headlights	•	•
Impact-Absorption Crumple Zones (front/rear)	•	•
Dual Side-Impact Door Beams	•	•
Heated Door Mirrors with Reverse Gear Tilt-Down Feature	•	•
Automatic Day/Night Rearview Mirror	•	•
Breakaway Inside Rearview Mirror	•	•
Sun Visors with Side Extensions	•	•

SAFETY FEATURES

	CL	TYPE S
Nonprotruding Switches and Controls	•	•
Collapsible Steering Column	•	•
Impact-Absorbing Interior Surfaces	•	•
Automatic Transmission Interlock Feature	•	•
All-Season, Steel-Belted Radial Tires	•	•
Center High-Mount Brakelight	•	•
All-Around Visibility (301.8°)	•	•
Rear Window Defroster	•	•
Front Side-Window Defoggers	•	•
Tinted Upper Windshield	•	•
Rear Seat Headrests	•	•
Safety Glass	•	•

WARRANTIES

Vehicle: 4-year/50,000-mile limited warranty*
Outer Body Rust-Through: 5-year/unlimited-mile limited warranty*
Accessories: 4-year/50,000-mile limited warranty**
3.2-Liter, V-6 Engine: No scheduled tune-ups required for 100,000 miles†

ENGINE

	CL	TYPE S
Type: Aluminum-Alloy	V-6	V-6
Displacement (liters)	3.2	3.2
Horsepower @ rpm (SAE net)	225 @ 5600	260 @ 6100
Torque (lbs-ft @ rpm)	216 @ 4700	232 @ 3500-5500
Compression Ratio	9.8:1	10.5:1
Valve Train: 24-Valve, SOHC VTEC	•	•
Fuel System: PGM-FI Multi-Point Fuel Injection	•	•
Ignition System: Direct Electronic	•	•
Emission System	LEV (ULEV in CA)	LEV

EXTERIOR DIMENSIONS

Wheelbase	106.9 in (2715 mm)	106.9 in (2715 mm)
Length	192.0 in (4875 mm)	192.0 in (4875 mm)
Height	55.5 in (1410 mm)	55.5 in (1410 mm)
Width	70.6 in (1795 mm)	70.6 in (1795 mm)
Track (front)	61.1 in (1555 mm)	61.1 in (1555 mm)
Track (rear)	61.0 in (1550 mm)	61.0 in (1550 mm)
Curb Weight	3461 lbs (1574 kg)	3538 lbs (1592 kg)

INTERIOR DIMENSIONS

Headroom (front/rear)	37.5 in (953 mm)/36.7 in (933 mm)	37.5 in (953 mm)/36.7 in (933 mm)
Legroom (front/rear)	42.4 in (1078 mm)/33.0 in (837 mm)	42.4 in (1078 mm)/33.0 in (837 mm)
Shoulder Room (front/rear)	56.4 in (1433 mm)/54.2 in (1377 mm)	56.4 in (1433 mm)/54.2 in (1377 mm)
Hiproom (front/rear)	52.9 in (1343 mm)/50.4 in (1281 mm)	52.9 in (1343 mm)/50.4 in (1281 mm)
Cargo Volume	13.6 cu ft	13.6 cu ft
Passenger Volume	90.0 cu ft	90.0 cu ft

BODY/SUSPENSION/CHASSIS

Body Type: Unit Body	•	•
Suspension: 4-Wheel Double-Wishbone/Multi-Link Rear	•	•
Stabilizer Bar (front/rear)	27.2 mm tubular/18 mm solid	27.2 mm tubular/19 mm solid
Steering: Variable-Assist Power Rack-and-Pinion	•	•
Turning Diameter, Curb-to-Curb	37.4 ft	39.4 ft
Brakes: 4-Wheel Disc w/ABS	•	•
Wheels	16" Alloy	17" Alloy
Tires	P205/60 R16 91V All-Season	P215/50 R17 93V All-Season

TRANSMISSION

	CL	TYPE S
Transmission: 5-Speed Automatic w/Sequential SportShift	•	•
Type: Front-Wheel Drive	•	•
Traction Control System (TCS)	•	•
Grade Logic Control System	•	•
Lockup Torque Converter	•	•
Ratios (:1)		
1st	2.563	2.563
2nd	1.551	1.551
3rd	1.021	1.021
4th	0.653	0.653
5th	0.470	0.470
Reverse	1.846	1.846
Final Drive	4.428	4.428

EPA/FUEL

City/Highway†	19/29	19/29
Fuel Capacity	17.2 gal	17.2 gal
Recommended Fuel	Premium	Premium

REMOTE FUEL-FILLER-DOOR RELEASE

For your convenience, the CL features a remote fuel-filler-door release system. Because the door can only be opened from inside the CL, it adds a measure of protection and security.

TILT-DOWN DOOR MIRRORS

When you shift into reverse gear, the passenger's side outside mirror tilts down to increase rear visibility, making you more aware of your surroundings and enhancing your safety.

*Ordinary maintenance items or adjustments, parts subject to normal wear and replacement and certain other items are excluded. See your Acura dealer for the terms and conditions of limited warranties. **When installed at the time of new-vehicle delivery. †Does not apply to fluid and filter changes or periodic inspections. Please refer to the maintenance section of your owner's manual to determine all appropriate maintenance intervals. ‡Gasoline with an octane number lower than 91 may be used, with reduced performance. Use for comparison purposes only. California figures are the same. Your mileage may vary.

EXTERIOR COLORS



NIGHTHAWK BLACK PEARL



DARK EMERALD PEARL

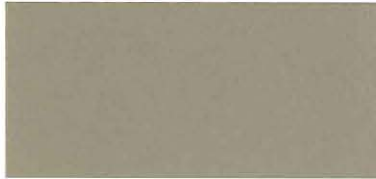

NAPLES GOLD METALLIC



SATIN SILVER METALLIC



SAN MARINO RED



SUNDANCE GOLD

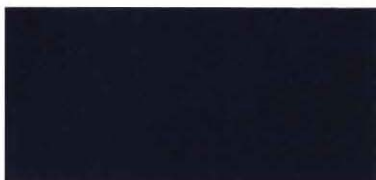

MONTEREY BLUE PEARL



TAFFETA WHITE

INTERIOR COLORS



EBONY LEATHER



PARCHMENT LEATHER



TYPE S EBONY LEATHER



TYPE S PARCHMENT LEATHER

EXPRESS YOUR PERSONAL TASTE. *The Acura CL is available in a variety of handsome colors. They are coordinated with interior colors that are designed to complement each other perfectly. All Acura vehicles benefit from an exhaustive multi-coat and multi-bake paint process. Each successive coat is inspected, washed and baked in a low-temperature oven. A clear coat is used as the final topcoat to enhance durability and provide a hard, lustrous surface.*

The interior leather surfaces are available in two elegant hues – Ebony and Parchment. The leather trim is made from hand-selected American hides crafted to ensure that the surface is flawless and free of blemishes or uneven colors. To create a proper fit and optimal durability, the leather pieces use a tighter stitch pattern than is usually found in auto upholstery. This tighter stitching is more durable over the life of the vehicle and, over time, also helps eliminate wrinkling.

EXTERIOR COLOR	INTERIOR COLOR 3.2CL	INTERIOR COLOR 3.2CL TYPE S
Nighthawk Black Pearl	Ebony or Parchment	Ebony or Parchment
Dark Emerald Pearl	Parchment	
Naples Gold Metallic	Parchment	
Satin Silver Metallic	Ebony	Ebony
San Marino Red		Ebony or Parchment
Sundance Gold		Ebony
Monterey Blue Pearl	Parchment	
Taffeta White	Parchment	Ebony or Parchment



1-800-TO-ACURA
www.acura.com

© 2000 Acura Division of American Honda Motor Co., Inc. Acura, CL, Total Luxury Care (TLC), Acura Satellite-Linked Navigation System and VTEC are trademarks of Honda Motor Co., Ltd. Specifications, features, illustrations and equipment shown in this catalog are based upon the latest available information at the time of publication. Although descriptions are believed to be correct, accuracy cannot be guaranteed. American Honda Motor Co., Inc. reserves the right to make changes at any time, without notice or obligation, in colors, specifications, accessories, materials and models. Some vehicles are shown with optional equipment. Bose is a registered trademark of Bose Corporation. HomeLink is a registered trademark of Prince Corporation, a wholly owned subsidiary of Johnson Controls.™ Acura reserves the right to limit TLC services or reimbursements to any owner or driver when, in the judgment of Acura, the claims become excessive in frequency or type of occurrence. Acura also reserves the right to alter or withdraw the Acura Roadside Assistance Program, or any other part of the Acura TLC Program, at any time without notice. Make an intelligent decision. Fasten your seat belt. Printed in the U.S.A. 200M 2/00 E4006

