

1981



P I C K U P

PICKUP

®

Jeep Pickup The Performance Truck.

For those of you considering a pickup, consider Jeep Pickup. . . the 4WD performance truck. Jeep is the one that can carry you and your cargo where no 2WD pickup could ever go and where most other 4WD pickups wouldn't dare go.

Jeep Pickup is the one with 4WD built in, not added on. We only make 4-wheel drive pickups, and we've been doing it since 1947. Our experience with 4WD systems goes back a lot further than that. Forty years ago the legendary little quarter-ton ancestor of Jeep Pickup established our reputation for off road performance, transporting materials and personnel over the shell-pocked terrain of World War II's Pacific and European Theaters.

Jeep Pickup is the only full size pickup available with a

choice of 4WD systems: standard part-time, or remarkable full-time automatic Quadra-Trac.*

Jeep Pickup offers other important advantages over competitive pickups. Its narrow body width, minimal front and rear overhang and tight turning radius allow it to go where others can't. Jeep Pickups have the highest payload capacities in their class, so they can carry more cargo in the double steel walled box. And because 4WD is a way of life at Jeep, the entry and exit height are easy to negotiate, and the overall truck silhouette pleasingly low.

If you think we've given you plenty of reasons to make Jeep your next pickup, we've only just begun. There's a lot more that's new for '81, including important powerteam refinements for improved performance and efficiency,† and bold, bright distinctive appearance packages to make your Jeep Pickup as good looking as it is hard working.

If you're looking for a truck with big payload capacity and winning performance, you're found it. Jeep Pickup.

† See EPA mileage statement on back cover.



Jeep race truck—a performance winner at the Baja 1000, SCORE Off-Road World Championship and other grueling off road races.

Jeep Pickup

With Jeep Pickup you're got a number of tough ways to go. It comes in two wheelbases, 119" or 131", 7' or 8' pickup box, 6200 lb. (J-10) or 6800 lb. (J-20)* GVW, sleek Townside or smart Sportside styling with balloon fenders.

It also comes with a remarkably complete roster of standards. Like new low-drag power front disc brakes and power steering. A rugged double steel wall cargo box on Townside models. There's electronic ignition for all weather starts. Beefy leaf springs to cradle the load. There's also a front sway bar, new drag reducing front air dam, and, of course, that famous dependable Jeep part-time 4-wheel drive with free-wheeling front hubs.

The standard J-10 powerteam is the 258 CID (4.2 liter) Six, and a tough-built, 4-speed, fully synchronized, manual transmission. The Six is 90 lbs. leaner this year for better performance whatever the task.

This year, the automatic transmission that's available with either Six or V8 power features a lock-up torque converter that provides improved highway performance. Our '81 Jeep Pickup profile features a new cab roofline for a contemporary look and better aerodynamics. Windshield upper molding, end caps and drip moldings are dressy new additions. The bold and handsome vertical slot grille is all new, too.

There are striking appearance packages to make The Performance Truck stand out even when it's standing still.

* N/A in California.



J-10 Townside



J-20 Custom Townside/two-tone (Shown with pickup box enclosure)



J-10 Honcho Sportside



J-10 Honcho Townside

Appearance & Equipment Packages. Custom Townside (J-10, J-20)

Jeep Pickup, with sleek Townside box, new cab profile and a smart new grille cuts a fine figure indeed. Other Custom interior and exterior features that heighten the tough-but-handsome-pickup effect are: a smartly tailored vinyl bench seat; deluxe door trim panels; upper bodyside moldings; bright door window moldings; engine turned instrument panel cluster; hood insulation; and a passenger assist handle.

Custom Sportside (J-10) (Not shown)

For the tough sporty look Jeep offers a short flare-side pickup box. It's called the Custom Sportside. It includes all of the features in the Custom package plus: a flare-side box with balloon fenders; 15 x 8 white spoke styled wheels; 10 x 15 OWL Tracker A/T tires; painted rear step bumper; vinyl trimmed bucket seats; and cab floor carpeting.

Honcho Sportside (J-10)

The boldness of "Honcho" is also available with Sportside styling. Honcho Sportside includes everything in the Custom Sportside package plus: special decals on the balloon fenders in addition to basic "Honcho" striping; wood box side and front panel rails; contoured roll bar; Western weave fabric clad bucket seats with matching door trim; and a soft feel sports steering wheel.

Jeep[®] Pickup

Honcho Townside (J-10)

Traditionally the boldest appearance package available on a full-size pickup. In addition to all of the Custom Pickup features Honcho includes: new bodyside tape striping and Honcho identification in three color combinations, red, blue or yellow depending on exterior color; new striping on the tailgate; cab floor carpeting; Western weave fabric bench seat; special door trim panels; soft feel sports steering wheel; 8" white styled steel wheels; 10-15 OWL Tracker A/T tires; and a rear step bumper.

Laredo Townside (J-10)

If there ever was an elegant pickup, this is it. Laredo equipment is available on J-10 short wheelbase Townside pickups. It includes everything in the Custom Package plus: special painted hub covers; 15 x 8 chrome styled wheels; 10R15 Wrangler steel radials; Chrome Grille; chrome rear step bumper; special "Laredo" nameplates; chrome remote control exterior left and right rearview mirrors; Special "Laredo" striping in silver and gray or nutmeg and bronze depending on exterior color; passenger assist handle; Extra Quiet Insulation; Convenience, Light and Visibility Groups; front bumper guards and nerf strips; Deluxe carpeting in black or nutmeg; high back bucket seats with center armrest and matching door trim panels in black with gray accents, or nutmeg with honey accents; door pull straps; black or nutmeg leather wrapped steering wheel; and special "Laredo" nameplate and striping on the instrument panel.

J-10 Laredo Townside



Interiors



Inside Jeep Pickup you'd never guess you were in a tough performance truck. Take the Laredo interior. (shown) Those are high back contoured buckets trimmed in black Cara vinyl with gray accent straps (Nutmeg & honey also available). The door trim panels, the carpeting, the headliner, instrument panel and sun visors are all carefully color-keyed. The Honcho bench seat features Western weave fabric in beige, blue or black. The Custom bucket seat interior is offered in beige, blue or black Cara vinyl with accent stripe as is the standard bench seat. And an optional bench seat comes in deluxe grain beige, blue, black or nutmeg vinyl.

Standard Features & Options

Standard:

- Ash tray
- Armrests, left and right
- Cigar lighter
- Floor covering—color-keyed vinyl
- Gauges—oil, ammeter, temp., fuel
- Glove box lock
- Heater & defroster
- Mirror—12" inside day/night
- Padded instrument panel
- Seat, bench
- Washers—electric, and 2-speed electric wipers
- Bumper—chrome-plated aluminum (front)
- Lights—head, parking, backup, tail, stop, directional signal (w/ lane-change detent), side safety marker, 4-way hazard flasher
- Moldings—bright vent window and windshield, with new windshield upper moldings, end cap and drip rails
- Air cleaner—cellulose fiber
- Air dam, front (new)
- Alternator 12-volt, 42-amp
- Battery—12-volt 55-380
- Brakes—self adjusting power front disc (new low drag type), rear drum
- Coolant (engine)—permanent w/Hi-Temp thermostat (50-50 mixture)
- Emission control system
- Engine—258 CID Six (J-10)
—360 CID V-8 (J-20)
- Exhaust system—single
- Fuel filters—tank and in-line at fuel pump
- Front stabilizer bar
- Hood release inside (new)
- Rear fender stone protection
- Shocks—front and rear
- Power steering
- Steering column—energy absorbing w/anti-theft ignition, steering and transmission lock
- Tools—jack, screw type, combined wheel wrench and jack handle
- Townside box—7 ft. (short wheelbase), 8 ft. (long wheelbase)
- Transmission—4-speed manual

Options:

- Two-tone paint
- Soft-feel sports steering wheel (incl. w/Honcho)
- Leather wrapped sports steering wheel (incl. w/Laredo)
- 15 x 8 painted styled wheels

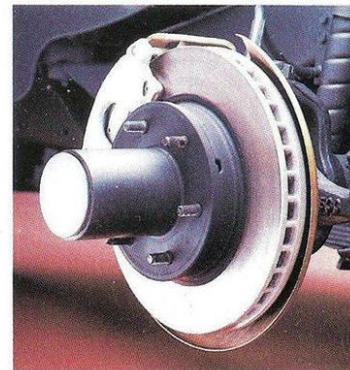

Power front disc brakes

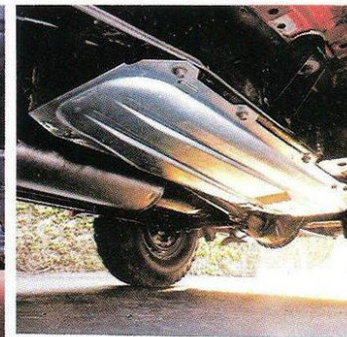

Fuel tank skid plate



Dual remote mirrors with swingaway feature

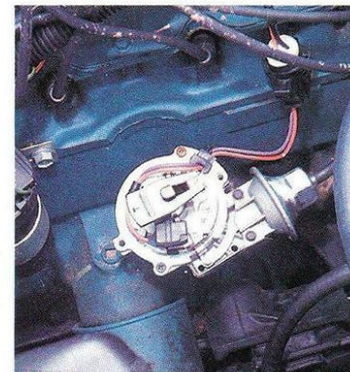

Electronic ignition system

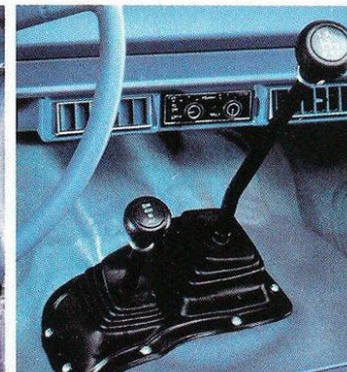

Part-time 4WD transfer case/4-speed transmission

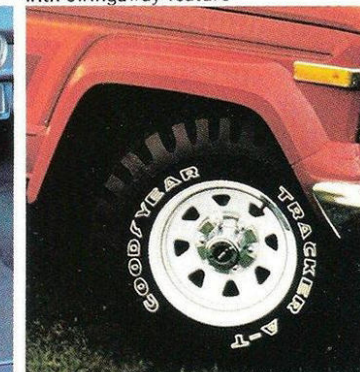

Fender extensions

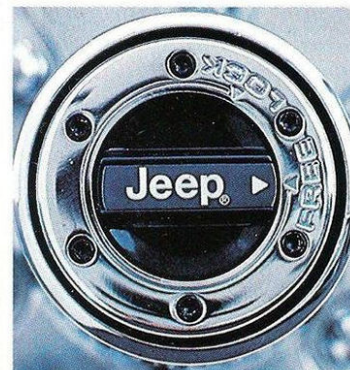

Free-wheeling front hubs

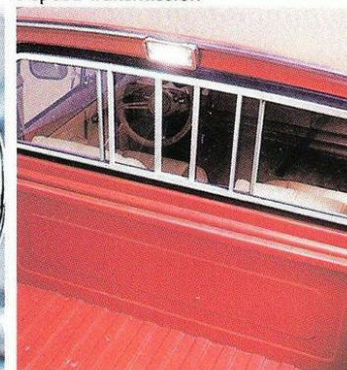

Sliding rear window/cargo box light



Roll bar

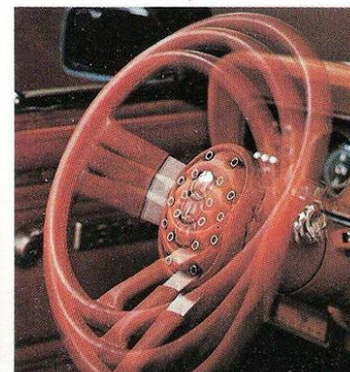

Tilt steering wheel

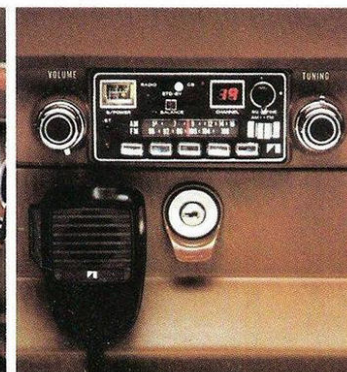

AM/FM/CB stereo

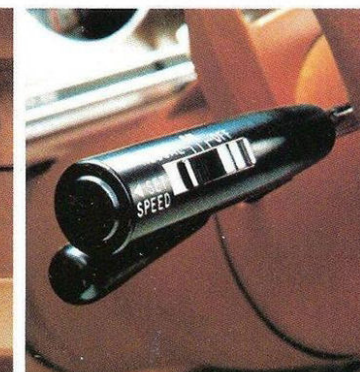

Cruise control

Options (cont'd.)

- 15 x 8 chrome styled steel wheels
- Convenience Group—includes underhood light; lights-on buzzer; digital clock (incl. w/Laredo)
- Light Group—includes cargo box light; courtesy lights; glove box light; ashtray light; map/dome light; lighted visor vanity mirror (incl. w/Laredo)
- Air conditioning
- Tinted glass
- Clear lens fog lamps
- Quartz Halogen headlamps
- Pickup box Cap—Townside
- AM radio and antenna
- AM/FM stereo radio and antenna
- AM/FM/CB stereo radio
- AM/FM/Cassette radio
- Premium audio system—includes power amplifier and higher fidelity speakers
- Dual front shock absorbers
- 360 CID 2-bbl. V-8 (N/A Calif.)
- Automatic transmission
- Quadra-Trac full-time automatic 4-wheel drive
- Heavy duty cooling
- Extra duty spring combinations
- Heavy duty shocks front & rear
- Cold climate group—includes heavy duty battery & alternator; engine block heater
- Bumper guards (front)
- Protective floor mats
- Roll bar
- Snow Boss Package—a complete snow plow installation hydraulic controls, plow lights, wiring and heavy duty engine and chassis components)

See your Jeep dealer for a complete list of options and factory approved accessories.



Chrome rear step bumper



Snow plow—dealer installed



Brush guard & fog lights



Chrome wheel



Aluminum wheel



Running boards—dealer installed

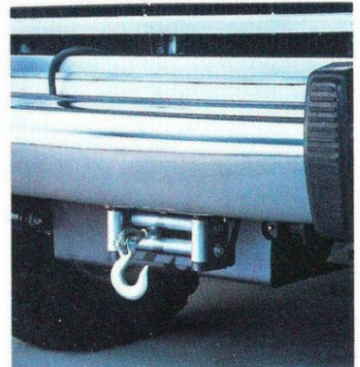

Hidden winch—dealer installed



Truck rails—dealer installed

Jeep Store

GENUINE JEEP PARTS AND ACCESSORIES ARE AVAILABLE ONLY FROM THE JEEP STORE... YOUR LOCAL JEEP DEALER.

Colors



4WD Systems

Nobody builds 4-wheel drive systems like Jeep does, because nobody knows more about 4-wheel drive. 40 years of design innovation in 4WD has taught us how to engineer in toughness and durability. It's also taught us how to make our componentry lighter without sacrificing that toughness. That's increasingly important as we move through the 80's, and as more owners start using their 4WD vehicles for conventional driving needs, as well. With Jeep Pickup you can have your 4-wheeling two ways: standard part-time with free wheeling front hubs; or remarkable Quadra-Trac full-time automatic 4-wheel drive.

Part Time

Part time Jeep 4-wheel drive with a 4-speed, fully-synchronized, manual transmission is standard on all J-10 Pickup models. (J-20 models feature a 4-speed manual transmission with "creeper" 1st gear.) Part time 4-wheel drive may also be teamed with an available automatic transmission.

In highway situations you simply slip the transfer case shift lever to the 2-wheel mode and unlock the front hubs. This disengages the front propeller shaft, front differential and front driving axles. Friction and noise are reduced accordingly.

For off road or bad weather conditions, just lock the front hubs, shift the transfer case to the 4-wheel mode and your Pickup becomes a go-anywhere-anytime performance truck.

Full time Quadra-Trac®

Quadra-Trac is a Jeep exclusive that provides sure-footed traction and a sense of security automatically while driving on highway in almost any weather or road

surface situation. It's also a superb and predictable 4WD system for the most demanding of off road situations.

A unique controlled slip differential in the transfer case sets Quadra-Trac apart from all other 4-wheel drive systems. When one wheel loses traction the controlled slip differential automatically delivers torque to the axle with the most traction helping to pull or push Jeep Pickup through trouble spots.

The process works instantly on any surface, resulting in excellent control, handling, stability and traction at all times, wherever you drive, and in all weather. That's security you'll be glad you have, in demanding driving situations.

Jeep Quadra-Trac automatic 4-wheel drive with automatic transmission is available for all Jeep Pickup models. Viscous drive and a straight through high efficiency drive train design provide smooth, quiet operation. You select the driving range depending upon the surface condition: 4-Wheel High for normal operation; Low-Lock for extra push/pull power; Hi-Lock for very demanding situations. And, of course, you never have to leave the comfort of your Jeep Pickup...it's all automatic.

Quadra-Trac® System

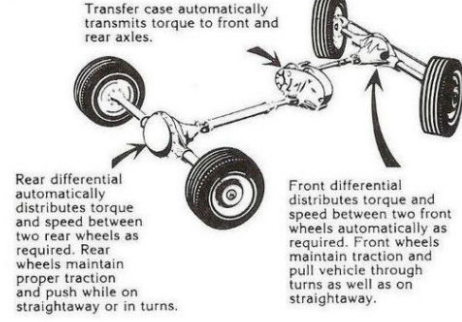

Vehicles illustrated in this brochure may vary slightly from actual production models.
 This folder does not constitute an offer or commitment to sell. In order that product improvements may be made at any time, specifications and other data are subject to change without notice. Jeep vehicles incorporate thousands of different components produced by Jeep Corporation, affiliated companies and various independent suppliers. From time to time during the manufacturing process, it may be necessary to produce Jeep vehicles with different components or differently sourced components than initially scheduled. All components must meet the standards of Jeep Corporation and will provide the performance expected from Jeep vehicles. Jeep vehicles meet or exceed all applicable Federal Motor Vehicle Safety Standards at time of manufacture. Some of the Jeep vehicles shown and described in this brochure have optional equipment. JEEP®, HONCHO, QUADRA-TRAC®, JEEP STORE are trademarks of Jeep Corporation. In Canada, American Motors (Canada) Limited is a licensed user. ® Reg. TM. Merchandising/Jeep Sales Promotion 8/80 FORM#: 1-5424-835-01

Tires

Cruiser flexible polyester cord diagonal ply tires are strong, smartly styled and provide good traction. H78 x 15—W/W H78 x 15—B/W

Wrangler radial tires bite deep in mud, sand and snow, are smooth and stable on the highway. 10R-15 OWL.

Tiempo double steel belted radials have 10,000 biting edges to grip the road in any weather. P225/75R15—W/W

F-32 Winter radials are made of Flexten for remarkable adhesion when driving on slippery winter pavement. HR78 x 15—W/W

Tracker A-T tires are a wide, all-terrain, all-weather tire designed for durability and rugged 4-WD use. 10 x 15—OWL

Cushion Miler tires are made with Tufsyn, the strongest wearing rubber ever used in Goodyear truck tires. 8.75 x 16.5—B/W 9.50 x 16.5—B/W

Custom Xtra Grip tires feature wide lugs for extra pulling power on ice and snow. 8.75 x 16.5—B/W 9.50 x 16.5—B/W

Suburbanite XG Polyglass sure gripping tread design for off road traction. L78 x 15 BSW

Suburbanite fiberglass belted. An excellent Town & Country tire for smooth ride and positive traction. H78 x 15 BSW

Viva Fiberglass belted tire. A strong all-around radial for highway and off road. P225/75R15 BSW WSW.

Jeep Pickup Specifications

Pickup Dimensions

(inches unless otherwise noted)

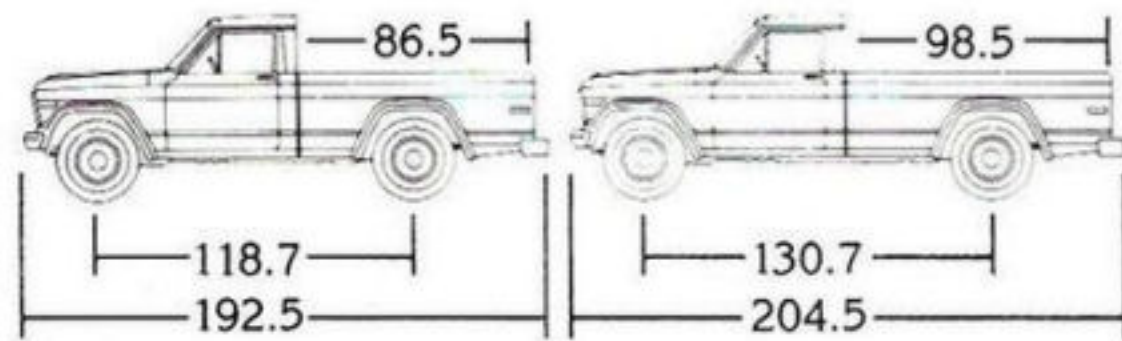

Exterior	J-10 Short Wheelbase	J-10/20 Long Wheelbase	J-10 Sport-side
Length	192.5	204.5	196.9
Wheelbase	118.7	130.7	118.7
Overall Width	78.9	78.9	78.9
Height	69.3	69.1/70.7	69.1
Tread, front	63.3/65.4(1)	63.3/64.6	
Tread, rear	63.8/64.9(1)	63.8/65.9	
Overhang (front/rear)	29.9/43.9	29.9/43.9	29.9/43.9
Min. ground clearance	7.7/8.6(1)	7.7/8.1	8.6(1)
Tailgate opening width	57.2	57.2	48.6
Turning diameter, Curb to curb (feet)	40.6/41.2(1)	44.5	41.2(1)
Interior			
Head room	40.2	40.2	40.2
Leg room	41.6	41.6	41.6
Hip room	60.5	60.5	60.5
Shoulder room	58.3	58.3	58.3
Cargo floor length	83.6	95.6	84.5
Cargo box volume (cu. ft.)	67	76.6	29.1

(1) Wide wheel model

Specifications

Axle, front	Full floating open-end; GAWR: 3200 lbs. (J-10), 3500 lbs. (J-20).
rear	J-10: Semi floating, GAWR: 3200 lbs. J-20: Full floating, 6800 GVW: GAWR rating 3980 lbs.; 7600 GVW: GAWR rating 4700 lbs.; 8400 GVW: GAWR rating 5500 lbs.
Brakes	New low-drag power disc front (12" J-10; 12½" J-20) Rear drum (11" x 2" J-10; 12" x 2½" J-20)
Clutch, diameter	11" 111 sq. in.
Fuel tank capacity	18.2 (approx.) gallons (w/skid plate)
4WD system	Part-time with manual free-wheeling front hubs. Available with automatic transmission. Quadra-Trac available.
Transfer case	2-speed Part-Time standard with 2.6 low range gear reduction
Glass Area	2883 sq. in.
Gross vehicle weight	6200 lbs. (J-10); 6800 lbs. (J-20); optional 7600 lbs. and 8400 lbs. (J-20)
Springs, front	5 leaf 215 lbs./in. rate std. (J-10) 7 leaf 260 lbs./in. rate std. (J-20)

rear	5 leaf 165 lbs./in. rate std. 119" WB J-10; 4 leaf 245 lbs./in. rate std. 131" WB J-10; 2 leaf tapered 340 lbs./rate std. J-20
Steering	Variable ratio power
Transmission	Fully synchronized 4-speed(2) manual floor shift standard; column mounted automatic transmission optional
Tires	Four H78-15 black side wall polyester Cruiser 78 (unbelted) std. J-10; Five 8.75-16.5 black side wall polyester Cushion Miler RV std. J-20; Temporary use polyspare (J-10)

Pickup Engine Availability

Engine	Carb.	Comp. Ratio	Bore & Stroke	Avail.
258 CID Six	2-bbl.	8.3:1	3.75" x 3.90"	std.J-10
360 CID V-8*	2-bbl.	8.25:1	4.08" x 3.44"	std.J-20 opt.J-10

* Not available in California.

EPA Mileage

22 Hwy. Est. MPG, (15) EPA Est. MPG (J-10)

Use these figures for comparison. Your results may differ due to driving speed, weather conditions and trip length. Actual highway mileage will be less. California and J-20 figures were not available at time of publication. Consult your Jeep Dealer.

(2) J-20 4-speed has creeper first gear



Jeep CJ

Drive one of our legends.



Jeep Cherokee

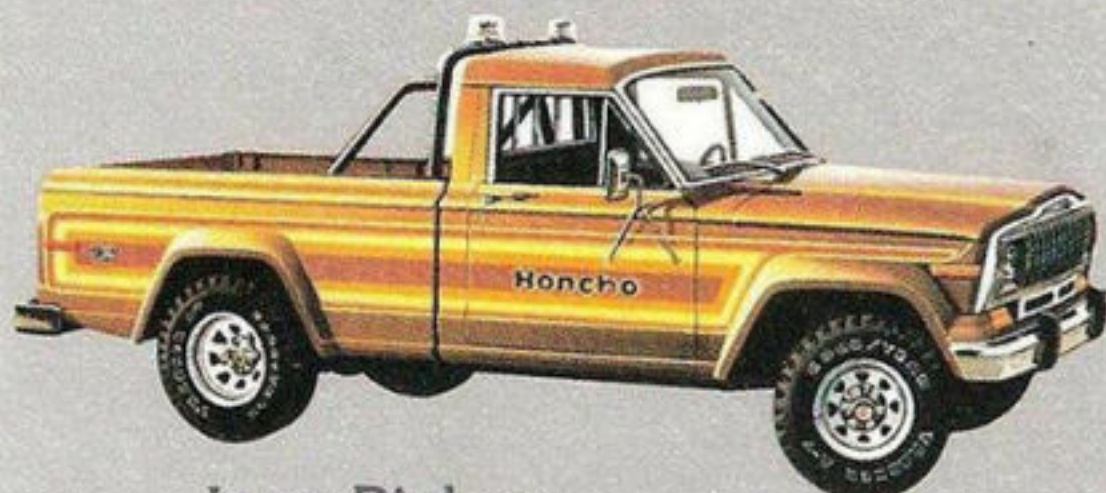

Jeep Pickup



Jeep Wagoneer



Jeep Corporation is a subsidiary of American Motors Corporation