

1981



W A G O N E E R

**WAGONER**

®

# Jeep Wagoneer The Ultimate Wagon.

Welcome to Jeep Wagoneer for 1981. Try as they may, full-size conventional wagons just can't measure up.

Inside, Wagoneer is comfortable, quiet, spacious replete with the conveniences and appointments full-size luxury wagon buyers (or, for that matter, luxury sedan buyers) want.

Outside, Wagoneer is a classic illustration of styling that is tasteful and timeless.

Underneath is the sure-footed security of Jeep's famous 4-wheel drive. It provides more traction, more driver control on road or off, and in any weather than conventional rear-wheel drive, or even front-wheel drive systems. And since the system is engineered by Jeep Corporation, with a rich heritage of 4-wheel drive excellence that goes back more

than 40 years, you can be sure that the system is rugged, reliable and durable.

The tradition of elegance and the engineering sophistication you've come to expect in Jeep Wagoneer has been retained. Plus we have some pleasant surprises for you in the 1981 edition. There is more Wagoneer variety to choose from which means you will find the ultimate wagon is now more affordable. Other engineering advancements, such as new low drag front disc brakes, have made the 1981 Jeep Wagoneer more efficient,† more practical, more sensible for the times we live in.

Right now, America needs a full size wagon with the advantages of 4-wheel drive and it has one...just one...Jeep Wagoneer, the ultimate family wagon. Test drive the elegant Jeep Wagoneer. It could be the last wagon you'll need for the rest of this decade.

† see EPA mileage statement on back cover.

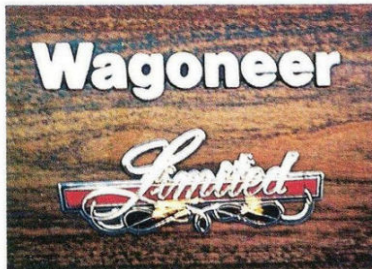

The mark of distinction.



# Jeep Wagoneer

For 1981, we've expanded the Wagoneer line to include the Custom model, new Brougham package and the incomparable Wagoneer Limited. The effect is that Wagoneer is now more affordable. So more families can take advantage of the sure-footed security of 4-wheel drive.

## Jeep Wagoneer Custom

The standard Wagoneer is the Custom...but it's hardly what you would call "standard". Power steering, new low-drag power front disc brakes, part-time 4WD with free-wheeling front hubs and 4-speed, fully synchronized manual transmission are all standard. The passenger area is richly carpeted and the seats elegantly trimmed in Cara grain vinyl.

The standard 258 CID six-cylinder engine is 90 lbs. leaner this year, for even more spirited performance and practicality.

New standard Goodyear "Viva" radials, a new front air dam and the low drag disc brake design, all combine to reduce Wagoneer's rolling resistance.

If you wish, you can team the standard Six and part-time 4-wheel drive system with the optional automatic transmission which features a lock-up torque converter. Either way the part-time system lets you select 2-wheel drive when you want it for on-road efficiency, or 4-wheel drive when you need it for sure-footed security for the family. Jeep's exclusive Quadra-Trac® automatic 4WD is also available.

You can order just about any convenience you want from Wagoneer's generous options and accessories list.



Wagoneer Custom



Wagoneer Limited



Wagoneer Limited



Wagoneer Brougham

## Jeep Wagoneer Brougham

The Wagoneer Brougham package is new for '81. It offers everything the Custom includes plus additional trim and convenience items that put it a cut above the Custom Wagoneer ...and way above most other full size wagons.

On the inside, there's luxurious Coventry Check fabric upholstery for the comfortable bench seat or available buckets. Or, if you prefer, Deluxe Grain vinyl. The available colors are black, blue, beige or nutmeg.

Premium door trim panels, soft headliner and woodgrain instrument cluster and horn cover complete the Brougham interior scheme.

Bright door frames, bright quarter window frames, and lower tailgate moldings dress up the Brougham exterior. The bodyside scuff molding with woodgrain insert is both handsome and protective. And the standard Wagoneer 'Viva' radials are set off by 15 x 7 chrome styled steel wheels.

On the functional side, the Brougham includes the following features: extra quiet insulation; the Convenience Group (including underhood light, lights-on buzzer and digital clock); the Light Group (including interior cargo light and tailgate switch, a lighted visor vanity mirror, and courtesy, map/dome, glove box and ashtray lights); a roof rack; protective floor mats; and a power tailgate window.

# Jeep<sup>®</sup> Wagoneer

## Jeep Wagoneer Limited

"Wagoneer Limited" says it all. It is the most completely equipped, elegantly appointed full size American wagon you can own. We've taken care of your family's comfort and convenience down to the last detail. The elegant Wagoneer Limited includes all of the Custom Wagoneer equipment plus bucket seats with leather/cord trim, center armrest and unique door panels (nutmeg or beige); leather wrapped steering wheel; extra thick 22 oz. carpeting in seating area (20 oz. in cargo area w/insulation); retractable cargo area cover; and woodgrain trim on the lower instrument panel.

Outside, the wide woodgrain side and rear treatment is set off with wide moldings; roof rack with woodgrain inserts; bright drip rails; forged 15" x 7" aluminum wheels (4); P225/75R15 Arriva-WSW radial (steel) tires and "Limited" nameplates.

On the functional side there's Quadra-Trac<sup>®</sup> automatic 4WD and automatic transmission; air conditioning; tinted glass; power windows/door locks; power tailgate window; cruise control; tilt steering wheel; AM/FM stereo radio; premium audio system; Convenience Group; Visibility Group; bumper guards & nerf strips; protective floor mats; Extra Quiet Insulation; and power six-way driver's and passenger seats.



# Interiors



Wagoneer has taken interior elegance to its highest plateau with the incomparable Limited. The full foam cushioned bucket seats with center armrest are beautifully tailored in genuine leather and corduroy in a choice of beige or new nutmeg. The Cara grain vinyl door trim panels, the full pile carpeting, the soft headliner, the padded instrument panel and visors are all carefully color-keyed. The Brougham package bench or optional bucket seats come in either rich Coventry Check fabric seat trim or Deluxe Grain vinyl in black, blue, beige or nutmeg. Custom Wagoneer bench seats are of Cara vinyl in black, blue or beige.

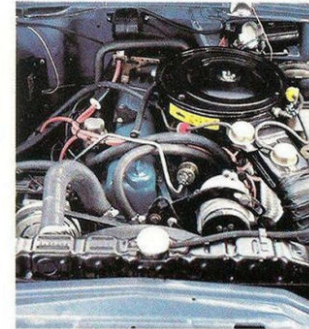

258 CID, Six, 2-barrel

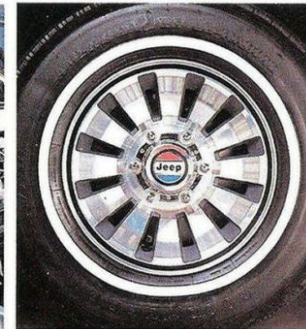

Aluminum wheels

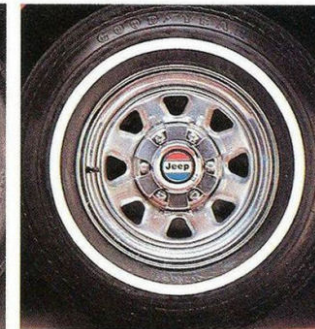

Chrome wheels

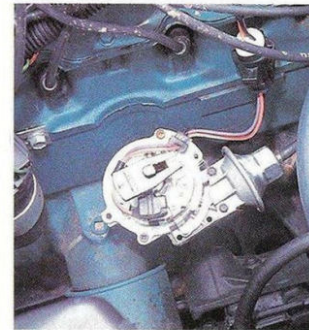

Electronic ignition system

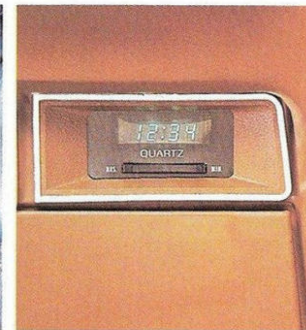

Quartz digital clock

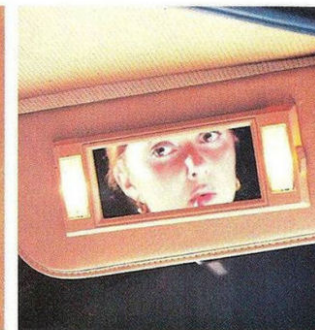

Lighted visor vanity mirror

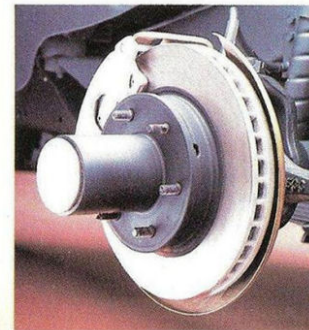

Power front disc brakes



Dual remote mirrors with swingaway feature

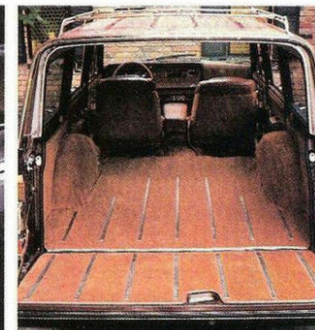

Folding and removable rear seat

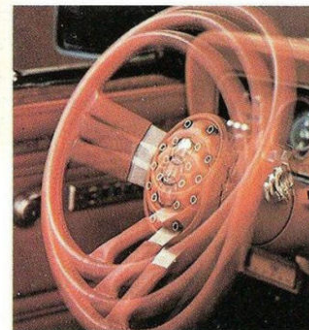

Tilt steering wheel



AM/FM/CB stereo

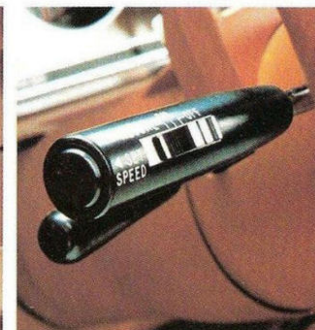

Cruise control

# Standard Features & Options

## Standard:

- Ash tray—front & rear
- Armrests—front & rear
- Cigar lighter
- Floor covering—carpeting (front & rear seat floor area & wheelhousing)
- Gauges—oil, ammeter, temp., fuel
- Glove box lock
- Heater & defroster
- Padded sun visors
- Washers—electric, and 2-speed electric wipers
- Bumpers—chrome plated aluminum
- Lights—head, parking, backup, tail, stop, directional signal (w/lane-change detent), side safety marker, 4-way hazard flasher
- Moldings—bright vent window and windshield, with new windshield upper moldings, end cap & drip rails
- Air cleaner—cellulose fiber
- Air dam, front (new)
- Alternator 12-volt, 63-amp
- Battery—12-volt 55-380
- Coolant (engine)—permanent w/Hi-Temp thermostat (50-50 mixture)
- Emission control system
- Engine—258 CID Six
- Exhaust system—single
- Power steering
- Transmission—4-speed, manual with part-time 4WD (Custom); Automatic with Quadra-Trac 4WD (Limited)
- Fuel tank skid plate
- Front stabilizer bar
- Hood release—inside (new)
- Steering column—energy absorbing w/anti-theft ignition, steering and transmission lock
- Tools—jack, screw type, combined wheel wrench and jack handle
- Tires—P225/75R15 Viva fiberglass radials

## Options:

- Two-tone paint
- Leather wrapped sports steering wheel (incl. w/Limited)
- Carpeted passenger and cargo areas (incl. w/Limited)
- Scuff molding
- Convenience Group—includes underhood light; lights on buzzer; digital clock (incl. w/Limited & Brougham)

## Options (cont'd.)

- Visibility Group—right & left matching remote outside mirrors; intermittent wipers; Halogen headlamps (incl. w/Limited)
- Light Group—includes interior cargo light and tailgate switch; courtesy lights; glove box light; ashtray light; map/dome light; lighted visor vanity mirror (incl. w/Limited & Brougham)
- Air conditioning (incl. w/Limited)
- Tinted glass (incl. w/Limited)
- Rear window defroster
- Inside spare tire mount and cover
- Clear lens fog lamps (incl. w/Limited)
- AM radio and antenna
- AM/FM stereo radio & antenna (incl. w/Limited)
- AM/FM/CB stereo radio
- Premium audio system—includes power amplifier and higher fidelity speakers (incl. w/Limited)
- 360 CID 2-bbl. V-8 (N/A Calif.)
- Part-time 4-wheel drive with free wheeling front hubs
- Heavy duty cooling
- Extra duty suspension package
- Heavy duty shocks front and rear
- Heavy duty 70-amp battery
- Heavy duty 70-amp alternator
- Cold climate group—includes heavy duty battery & alternator; engine block heater
- Bumper guards—front & rear (incl. w/Limited)
- Brush guard
- Protective floor mats (incl. w/Limited & Brougham)
- Snow Boss Package—a complete snow plow installation (hydraulic controls, plow lights, wiring & heavy duty engine & chassis components)
- Trailer Towing—See your Jeep dealer for information about special trailer towing packages & for details on other factory options not included in this listing, & for a select list of dealer installed accessories.



6-way power seat

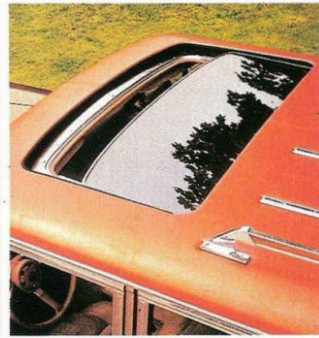

Power moon roof (Limited only)

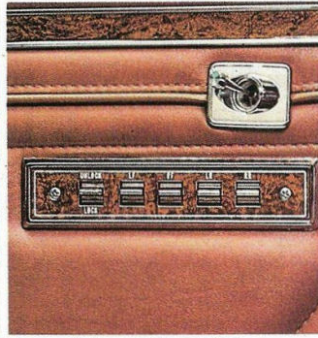

Power windows and door locks



Power tailgate window



Vinyl roof (with moon roof only)



Ski carrier—dealer installed



Cargo area cover



Hidden winch—dealer installed

**Jeep** Store  
GENUINE JEEP PARTS AND ACCESSORIES ARE AVAILABLE ONLY FROM THE JEEP STORE... YOUR LOCAL JEEP DEALER.

## Colors



## 4WD Systems

Nobody engineers 4-wheel drive systems like Jeep Corporation does, because nobody knows more about 4-wheel drive. 40 years of design innovation in 4WD has taught us how to engineer in toughness and durability. It's also taught us how to make our componentry lighter without sacrificing that toughness. That's increasingly important as we move through the '80s, and as more owners start using their vehicles for conventional driving needs, as well. With Jeep Wagoneer you can select your vehicle two ways: Quadra-Trac automatic 4-wheel drive (standard on Limited), or the part-time system with free wheeling front hubs (standard on Custom).

### Full Time Quadra-Trac®

Quadra-Trac is a Jeep exclusive that provides sure-footed traction and a sense of security automatically while driving on highway in any weather or on any road surface. It's also a superb and predictable 4WD system for the most demanding of off road situations.

A unique controlled slip differential in the transfer case sets Quadra-Trac apart from all other 4-wheel drive systems. When one wheel loses traction the controlled slip differential automatically delivers torque to the axle with the most traction helping to pull or push Wagoneer through trouble spots.

The process works instantly on any surface, resulting in excellent control, handling, stability and traction at all times, wherever you drive, and in all weather. That's security you'll be glad you have, in demanding driving situations.

Jeep Quadra-Trac automatic 4-wheel drive with automatic

transmission is standard on Wagoneer Limited and available on Wagoneer Custom. Viscous drive and a straight through high efficiency drive train design provide smooth, quiet operation. You select the driving range depending upon the surface condition: 4-Wheel High for normal operation; Low-Lock for extra push/pull power; Hi-Lock for very demanding situations. And, of course, you never have to leave the comfort of your Wagoneer...it's all automatic.

### Quadra-Trac® System

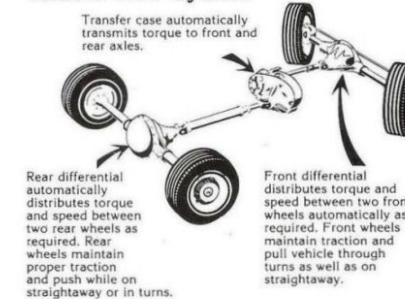

### Part Time

Part time Jeep 4-wheel drive with a 4-speed, fully-synchronized manual transmission is standard on Wagoneer Custom. An optional automatic transmission teamed with the part-time system is available on all Wagoneer models.

In highway situations you simply slip the transfer case shift lever to the 2-wheel mode and unlock the front hubs. This disengages the front propeller shaft, front differential and front driving axles. Friction and noise are reduced accordingly.

For off road usage, just lock the front hubs, shift the transfer case to the 4-wheel mode and your Wagoneer becomes a go-anywhere-anytime vehicle for you, your family and all the luggage and provisions you need.

Vehicles illustrated in this brochure may vary slightly from actual production models.

This folder does not constitute an offer or commitment to sell. In order that product improvements may be made at any time, specifications and other data are subject to change without notice. Jeep vehicles incorporate thousands of different components produced by Jeep Corporation, affiliated companies and various independent suppliers. From time to time during the manufacturing process, it may be necessary to produce Jeep vehicles with different components or differently sourced components than initially scheduled. All components must meet the standards of Jeep Corporation and will provide the performance expected from Jeep vehicles. Jeep vehicles meet or exceed all applicable Federal Motor Vehicle Safety Standards at time of manufacture. Some of the Jeep vehicles shown and described in this brochure have optional equipment. JEEP, QUADRA-TRAC, WAGONEER, JEEP STORE are trademarks of Jeep Corporation. In Canada, American Motors (Canada) Limited is a licensed user. Reg. TM, Merchandising/Jeep Sales Promotion 8/80 FORM# 1-5424-835-01

## Tires

Tiempo double steel belted radials have 10,000 biting edges to grip the road in any weather. P225/75R15—W/W

Arriva Steel Radial is a new American standard for radial tire performance. P225/75R15

F-32 Winter radials are made of Flexten for remarkable adhesion when driving on slippery winter pavement. HR78 x 15—W/W

Suburbanite fiberglass belted. An excellent Town & Country tire for smooth ride and positive traction. H78 x 15 BSW P225/75R15

Viva Fiberglass belted tire. A strong all-around radial for highway and off road. P225/75R15 BSW WSW.

# Jeep Wagoneer Specifications

## Wagoneer Dimensions

(inches unless otherwise noted)

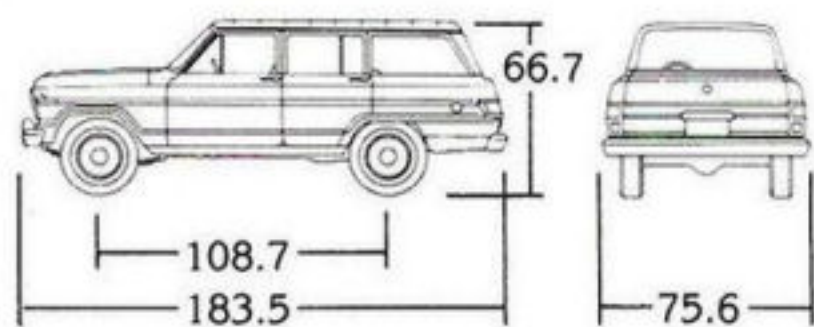

### Exterior

Length	183.5
Wheelbase	108.7
Overall Width	75.6
Body Width	74.0
Height	66.7
Tread (front/rear)	59.4/57.8
Overhang (front/rear)	29.9/44.9
Min. ground clearance	7.7
Tailgate opening width	54.9
Turning diameter, Curb to curb (feet)	37.7

### Interior

Head room (front/rear)	38.0/37.2
Leg room (front/rear)	41.6/37.0
Hip room (front/rear)	60.5/60.9
Shoulder room (front/rear)	58.3/58.3
Cargo volume (cu. ft.)	95.1*

\* Rear seat removed.

## Specifications

<b>Axle, front</b>	Full floating open-end; GAWR: 3200 lbs.
<b>rear</b>	GAWR: 3200 lbs.
<b>Brakes</b>	New low-drag power disc front (12" rotor); rear drum (11" x 2")
<b>Fuel tank capacity</b>	20.3 (approx.) gallons (w/skid plate)
<b>4WD system</b>	Part-time with manual free-wheeling front hubs (standard on Custom), Quadra-trac full-time automatic (standard on Limited)
<b>Glass Area</b>	5142.5 sq. in.
<b>Gross vehicle weight</b>	6200 lbs.
<b>Springs, front</b>	6 leaf 210 lbs./in. rate std.
<b>rear</b>	5 leaf 165 lbs./in. rate std.
<b>Steering</b>	Variable ratio, power
<b>Transmission</b>	Fully synchronized 4-speed manual floor shift (standard on Custom), automatic (standard on Limited, optional on Custom).
<b>Tires</b>	P225/75R15 BSW Viva fiberglass radials (Wagoneer Custom), P225/75R15 WSW, Arriva Steel radials (Limited). Temporary use polyspare.

### Wheels

15 x 6 six-bolt, 5.5" circle standard; four 15 x 7 six-bolt, 5.5" circle forged aluminum wheels std. Wagoneer Limited (optional on Wagoneer)

## Wagoneer Engine Availability

Engine	Carb.	Comp. Ratio	Bore & Stroke	Avail.
258 CID Six	2-bbl.	8.3:1	3.75" x 3.90"	std.
360 CID V-8*	2-bbl.	8.25:1	4.08" x 3.44"	opt.

\* Not available in California.

Jeep engines utilize overhead valve configuration, lightweight, compact engine block castings and ambient air intake system for improved engine performance, greater durability and longer life.

## EPA Mileage

22 Hwy. Est. MPG, **15** EPA Est. MPG

Use these figures for comparison. Your results may differ due to driving speed, weather conditions and trip length. Actual highway mileage will be less. California figures were not available at time of publication. Consult your Jeep Dealer.



Jeep CJ



Jeep Pickup

Drive one of our legends.



Jeep Cherokee



Jeep Wagoneer



Jeep Corporation is a subsidiary of American Motors Corporation