

JAGUAR XE



THE ART OF PERFORMANCE





BY APPOINTMENT TO
HM THE QUEEN
MANUFACTURERS OF
MOTOR VEHICLES
JAGUAR LAND ROVER LIMITED
COVENTRY



BY APPOINTMENT TO
HRH THE DUKE OF EDINBURGH
MANUFACTURERS OF
MOTOR VEHICLES
JAGUAR LAND ROVER LIMITED
COVENTRY



BY APPOINTMENT TO
HRH THE PRINCE OF WALES
MANUFACTURERS OF
MOTOR VEHICLES
JAGUAR LAND ROVER LIMITED
COVENTRY



THE ART OF PERFORMANCE

Every day we push performance to its limit. Our performance. Our cars' performance.
We innovate, we engineer, we design. We master rules and then break them.
Only to push further. Past the limits of convention. This is when performance becomes art.

Jaguar. The Art of Performance.



CONTENTS

INTRODUCTION

Concept of the XE	07
The XE - The Facts	08

DESIGN

Exterior Principles	10
Exterior Detail	12
Interior	17

PERFORMANCE

Engines	18
Advanced Aerodynamics	22
Lightweight Aluminum Architecture	25
Chassis and Suspension	26

DRIVING TECHNOLOGY

Advanced Driving Dynamics	29
All Surface Progress Control	30
Advanced Drivetrain Technology	33
Torque Vectoring	35
Stability and Control	36
Head-Up Display	39

INFOTAINMENT

Jaguar InControl® Technologies	40
InControl Touch™	43
InControl Touch Pro™	45
Audio	46

ASSISTANCE AND EFFICIENCY

Advanced Driver Assistance	48
Efficient Technologies	50

PERSONALIZATION

The XE - Your Choice	52
Choose your Engine	54
Choose your Model & Packages	56
Choose your Color	64
Choose your Wheels	66
Choose your Interior	68
Choose your Accessories	78
Technical Specifications	82
Dimensions	84

JAGUAR WORLD

Jaguar Experience	86
The World of Jaguar	88
Glossary and Legal Information	90



Scan to find out more about the Jaguar XE.

VEHICLE SHOWN: XE R-SPORT IN BLUEFIRE WITH OPTIONAL FEATURES FITTED

SOME OF THE VEHICLES FEATURED IN THE PHOTOGRAPHS THROUGHOUT THIS BROCHURE ARE EUROPEAN MODELS AND MAY NOT BE AVAILABLE IN NORTH AMERICA. PLEASE CONSULT YOUR LOCAL JAGUAR RETAILER FOR SPECIFIC MODEL AVAILABILITY.





INTRODUCTION

THE CONCEPT OF THE XE

One of the most advanced and refined sports sedan that Jaguar has ever produced. Instantly recognizable as a Jaguar, it feels like a Jaguar, it drives like a Jaguar - The XE is a Jaguar to its core.

The XE is the foundation of the Jaguar sedan family. A distillation of the design, luxury and technology found in the XF and the XJ. Inspired by the F-TYPE sports car, with its assertive looks and agile drive.

The XE comes with the option of All Wheel Drive with Intelligent Driveline Dynamics which gives it greater capability in challenging road conditions⁵. You can also upgrade to the very latest in-car infotainment with our powerful new InControl Touch Pro™ system¹.

The XE is an exceptional blend of technology, design, and driving dynamics that rewrites all the rules. The XE is a wake up call for every other car in its class.

VEHICLE SHOWN: XE R-SPORT IN ITALIAN RACING RED WITH OPTIONAL FEATURES FITTED
Disclaimers apply. Please see page 90 for further details.

THE XE - THE FACTS

The XE brings together the latest Jaguar innovation, technology and design.

EFFICIENCY AND PERFORMANCE

The XE is capable of achieving a drag coefficient as low as Cd 0.28. It cuts through the air to improve efficiency⁷ and refinement. From the outright exhilaration of a supercharged V6 to the 318 lb-ft of torque produced from our turbocharged 4-cylinder diesel, there are a range of engines to suit every driving style.

JAGUAR ELITECARE

BEST IN CLASS COVERAGE*

5 YEARS 60,000 MILES

JAGUAR ELITECARE

Enjoy your Jaguar with complete peace of mind. The XE is now backed by the Best-In-Class Jaguar EliteCare*, our exceptional 5 year / 60,000 mile coverage program including New Vehicle Limited Warranty, Complimentary Scheduled Maintenance, Roadside Assistance and InControl Remote & Protect™.

VEHICLE SHOWN: XE R-SPORT IN ITALIAN RACING RED WITH OPTIONAL FEATURES FITTED

*Class is cars sold by luxury automobile brands and claim is based on total package of warranty, maintenance and other coverage programs. For complete details regarding Jaguar EliteCare coverage, visit JAGUARUSA.COM, call 1.800.4.JAGUAR or visit your local Jaguar Retailer. Disclaimers apply. Please see page 90 for further details.

CAPABILITY

The XE offers our unique All Wheel Drive with Intelligent Driveline Dynamics and Adaptive Surface Response. Available with selected engines, these systems are designed to enhance the legendary Jaguar handling, agility and ride, and gives added confidence in all conditions⁵.

ADDED INTELLIGENCE

Innovative technologies make every drive easier and safer. The XE offers Adaptive Bi-function Xenon Headlamps, Traffic Sign Recognition and Adaptive Speed Limiter, Lane Keep Assist with Driver Condition Monitor, Autonomous Emergency Braking, Adaptive Cruise Control with Queue Assist, and Advanced Park Assist⁵.

ALWAYS CONNECTED

InControl Touch Pro™ is now available in the XE. This next generation infotainment system offers a range of new features to enhance every journey. These include, Meridian Digital Sound Systems and Connected Navigation¹.



LIGHTWEIGHT ALUMINUM ARCHITECTURE

The lightweight architecture of the XE creates an incredibly strong body - underpinning power with responsive handling, and refinement with beautiful design.



DESIGN EXTERIOR PRINCIPLES

> DYNAMIC PROPORTIONS | MUSCULAR LOOKS

VEHICLE SHOWN RIGHT: XE R-SPORT IN ITALIAN RACING RED
WITH OPTIONAL FEATURES FITTED

"It's about paring it down to the bare essentials. Good designers have always said less is more."
Ian Callum, Jaguar Design Director.

The XE stands out from the competition with the clean surfaces and dynamic looks that form the core of Jaguar design. This is because the Lightweight Aluminum Architecture gave its designers the freedom to work alongside engineers to optimize the car's proportions – The XE is unmistakably a Jaguar. The long, distinctly defined hood is aerodynamically sculpted to channel air over and around the body for greater efficiency. Along with the rising waistline and 'cab rearward' design, it ensures that the XE shares the athleticism of the other cars in the Jaguar range. The XE is crouching, ready to pounce.



EXTERIOR DETAIL

INNOVATIVE DESIGN

One glance at the XE and you know that it could only be a Jaguar. From the headlamps featuring Jaguar signature 'J' blade Daytime Running Lamps*, the powerfully sculpted hood, and the chrome side vents, stamped with the Jaguar name, all the way to those distinctive rear haunches. Only Jaguar, as a world leader in aluminum car construction, has the technology and expertise to create sharper creases from deeper, more innovatively formed pressings. The body side curvature of the XE is aerodynamically honed to sweep air seamlessly rearwards to the tail. The deliberately cropped rear has a short overhang, underscoring the car's performance credentials and enhancing airflow. It culminates with those iconic tail lights that are inspired by the F-TYPE sports car.

*Available with Bi-function Xenon and Adaptive Bi-function Xenon headlamps only.
VEHICLE SHOWN: XE R-SPORT IN BLUEFIRE WITH OPTIONAL FEATURES FITTED













INTERIOR

> COCKPIT FEEL | EXTENSIVE CHOICE

Connect with XE the moment you slide into the form-hugging seats - you sit low in a Jaguar. Next to you the raised center console adds to the cockpit feel.

Pulsing with a heartbeat, the car creates an emotional connection between driver and machine. Its 72 per minute double beat is the same as a jaguar cat at rest. Press the Start button and XE awakes, the needles sweep, the engine growls. The JaguarDrive Selector rises to greet your hand.

The outer air vents are unique in the way that they extend the fascia to nestle in the door casings and give the feeling of width and space. Throughout XE the natural forms of the interior architecture lend themselves to the extensive choice of contemporary or traditional materials and finishes. XE is an inspired place for driver and passengers to be.

INTERIOR SHOWN LEFT AND PREVIOUS PAGE: XE R-SPORT FEATURING JET LEATHER SPORT SEATS WITH RED LEATHER INSERTS WITH OPTIONAL FEATURES FITTED

PERFORMANCE ENGINES



INGENIUM ENGINES

STOP/START TECHNOLOGY

The XE is offered with a range of highly advanced gas and diesel engines, including the 4-cylinder turbocharged diesel engine from our Ingenium engine family. Whether you choose our latest hi-tech diesel engines or you prefer gas, each one offers performance, refinement and economy⁷ to suit every driving style. The engines are equipped with Stop/Start technology and smart regenerative charging – harvesting kinetic energy from braking to charge the battery – for maximum economy, especially during city driving.



INGENIUM DIESEL ENGINES

318 lb.ft. of Torque

The XE is offered with the 2.0 liter 4 cylinder 180HP Turbocharged Diesel from our Ingenium range. Ingenium is the new breed of engine designed by Jaguar Land Rover for effortless performance, refinement and efficiency⁷. With advanced technology and all-aluminum construction Ingenium delivers impressive fuel consumption and CO₂ emissions. Typically, 44 lbs lighter than equivalent previous generation engines, Ingenium is intrinsically more efficient.

And intelligent too – computer controlled, adaptive engine cooling only engages as required. The latest generation variable geometry turbocharger maximizes peak power for low speed torque and responsiveness that is uniform, progressive and avoids lag. Internal friction – the enemy of performance and efficiency – is 17 percent lower in the Ingenium range than previous generation engines.

Disclaimers apply. Please see page 90 for further details.



TURBOCHARGED GAS ENGINES

0-60mph from 6.5 sec

The XE is also offered with the 4-cylinder turbocharged gas engine that offers power and responsiveness throughout the rev range, while improving efficiency⁷. The 2.0 liter 4-cylinder turbocharged gas (240HP) engine achieves 6-cylinder engine levels of performance⁸ and refinement from a more compact and economical structure.

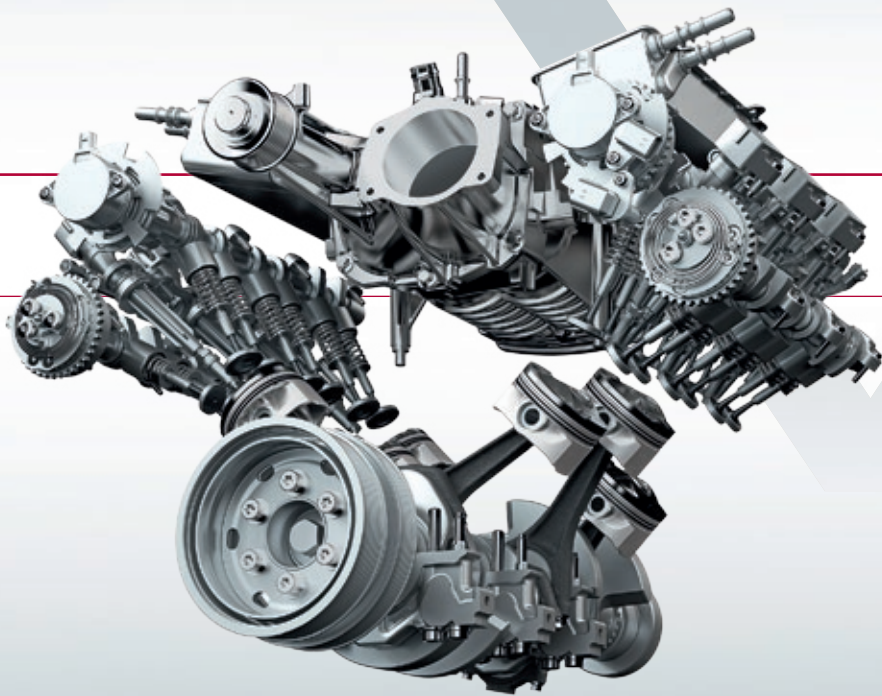

SUPERCHARGED GAS ENGINE

0-60mph from 5.1 sec

The 3.0 liter 340HP V6 supercharged engine has been adapted for the specific requirements of the XE. A Roots-type twin vortex supercharger is mounted in the 'V' between the two rows of cylinders for compact dimensions. Supercharging provides linear delivery of power and maximizes responsiveness. This results in performance⁸ matching much larger engines, while optimizing economy and reducing emissions. The engine also features dual independent variable cam timing to vary inlet and exhaust valve operation, working alongside lightweight pistons with ultra-low friction piston rings, for increased performance and efficiency⁷. For added refinement there is a twin, contra-rotating balancer shaft system.

VEHICLE SHOWN: XE R-SPORT IN AMMONITE GREY WITH OPTIONAL FEATURES FITTED

Disclaimers apply. Please see page 90 for further details.



ADVANCED AERODYNAMICS



ADVANCED AERODYNAMICS

EFFICIENT⁷

The XE form has been rigorously optimized for aerodynamic efficiency and stability. With a drag co-efficient as low as Cd 0.28*, The XE cuts through the air - reducing fuel consumption and lowering emissions. Every element exploits the exterior's maximum aerodynamic potential while preserving the stunning proportions of the XE. Vertical apertures in the front bumper's outer edges channel air through vents in the wheel arches and out over the front wheels. Even the race car-inspired underbody protection and diffuser is designed to make the XE as efficient, economical and refined as possible.

*Engine and model dependent.

VEHICLE SHOWN: XE R-SPORT IN BLUEFIRE WITH OPTIONAL FEATURES FITTED

Disclaimers apply. Please see page 90 for further details.



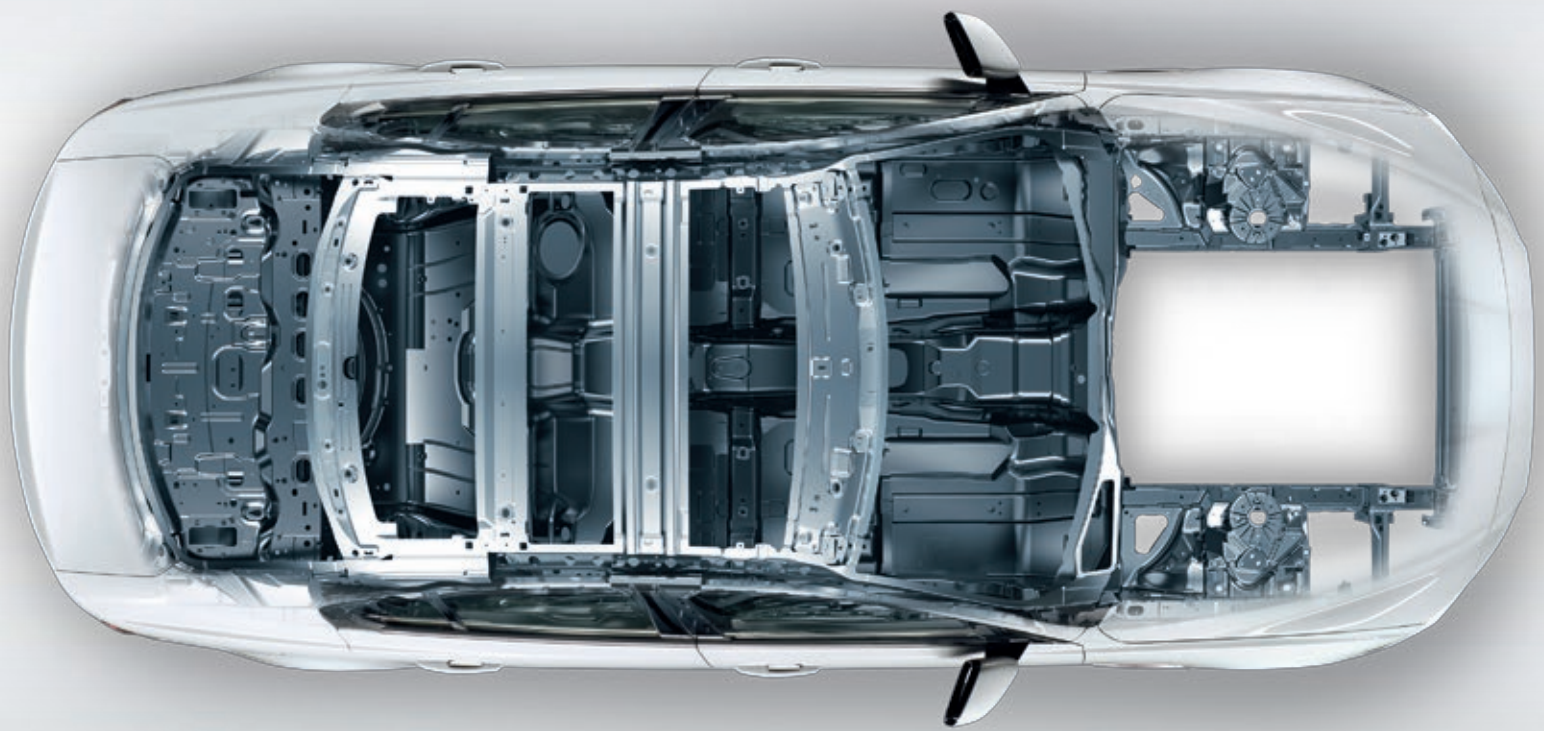

LIGHTWEIGHT ALUMINUM ARCHITECTURE



BALANCED

STRONG AND LIGHTWEIGHT

Jaguar has been at the forefront of aluminum car construction for more than a decade and continues to push the boundaries of this technology. The XE is based on our Lightweight Aluminum Architecture, which uses expertise derived from the aerospace industry to deliver premium vehicle characteristics in performance and refinement. This immensely strong bodysell uses a high strength 6000 series aluminum alloy. Saving weight without compromising durability, it provides very high torsional stiffness, supporting precise handling. It helps achieve optimum weight distribution approaching 50:50. The lightweight structure not only reduces fuel consumption and CO₂ emissions, it means that the XE range is able to achieve a maximum speed of up to 155mph⁸.

Disclaimers apply. Please see page 90 for further details.

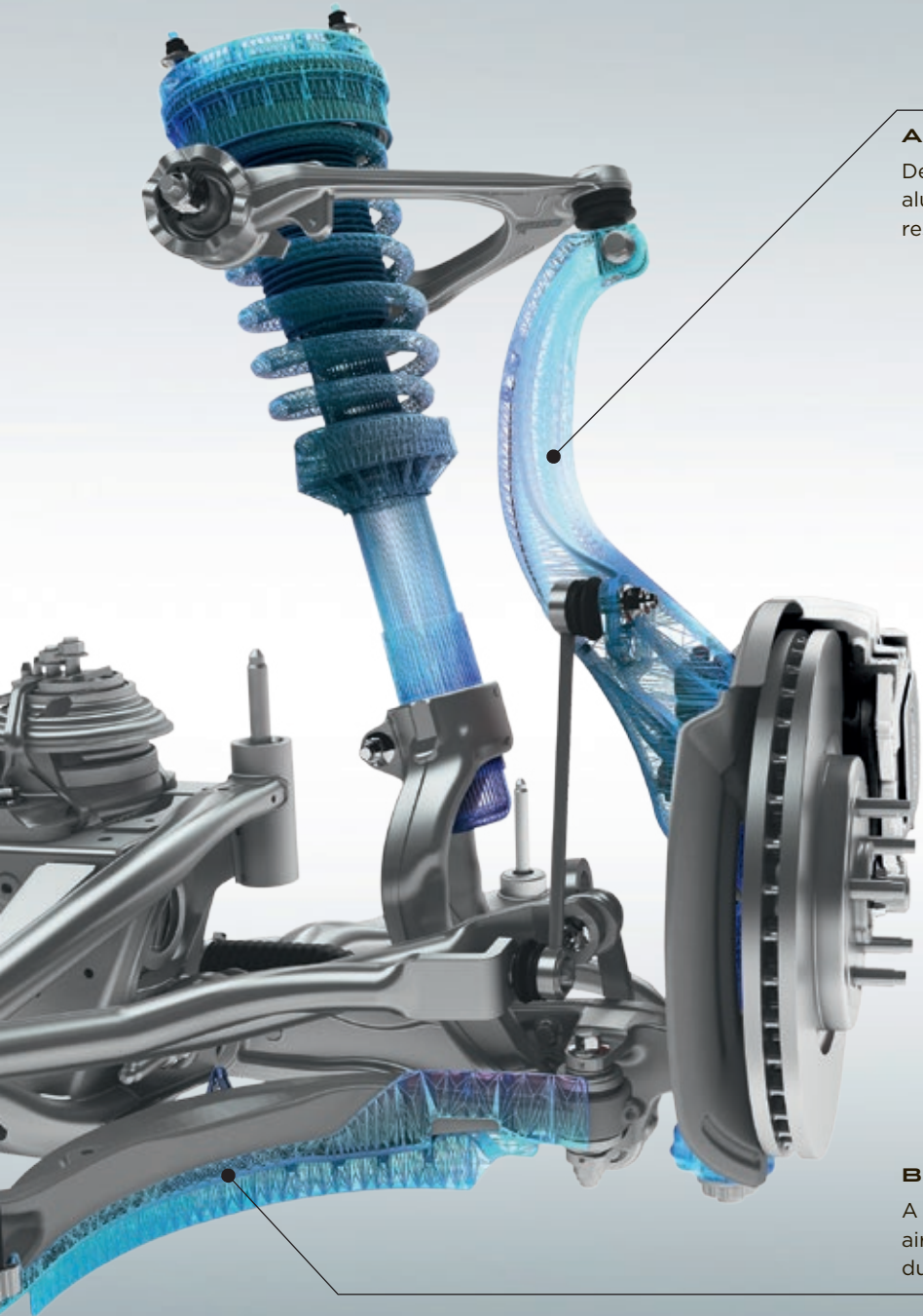

ALUMINUM FRONT KNUCKLE

Designed to optimum stiffness and strength, the lightweight aluminum front knuckle helps improve XE agility, responsiveness and refinement for sports-car-like control.

CHASSIS AND SUSPENSION



UNIQUE SUSPENSION
TECHNOLOGY

COMFORTABLE
AND DYNAMIC

The XE responds with agility and performs with dynamism while always maintaining ride comfort – it's a unique balance that makes it a Jaguar. The ideal foundation for these driving dynamics is light, yet exceptionally strong and stiff, Lightweight Aluminum Architecture with its near 50:50 weight distribution.

The sophisticated front and rear suspension systems complete a chassis that achieves a superb combination of sportiness and refinement. Advanced damper technologies – both passive and adaptive – further improve ride quality and extend the XE breadth of dynamic capabilities. The suspension's control, agility and feedback give the XE the spirit of a sports car.

BRAKE SCOOP

A glass-filled polypropylene brake scoop channels air onto the brakes for enhanced brake performance during enthusiastic driving.

INTEGRAL LINK REAR SUSPENSION

Integral Link rear suspension allows the XE to realize a perfect combination of a refined, luxurious ride and sharp, responsive handling. The system, separates and independently manages the lateral, longitudinal and vertical forces acting on the suspension for enhanced control and comfort. Many components are forged or hollow-cast in aluminum – the optimum production techniques for strong, lightweight suspension.

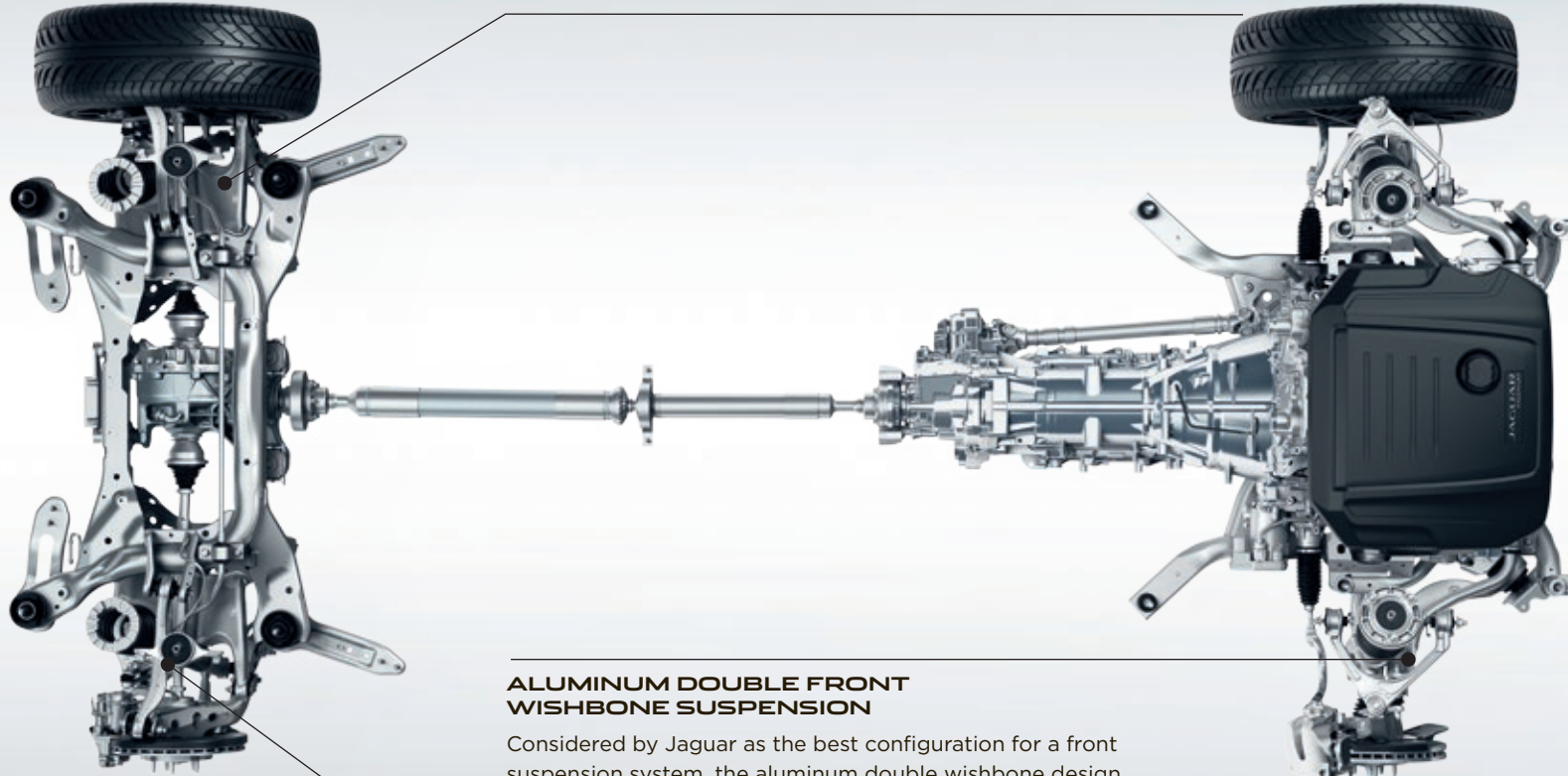

ALUMINUM DOUBLE FRONT WISHBONE SUSPENSION

Considered by Jaguar as the best configuration for a front suspension system, the aluminum double wishbone design is modelled closely on the F-TYPE for precise handling and steering response.

ADAPTIVE DYNAMICS

The optional Adaptive Dynamics system delivers both precise dynamics and a supple, luxurious ride by monitoring wheel position and body movements. The system adjusts the dampers to provide the optimum balance between comfort and refinement at all times⁵.



DRIVING TECHNOLOGY ADVANCED DRIVING DYNAMICS



MAXIMIZING AGILITY

CONTINUOUSLY ADAPTING

ELECTRIC POWER ASSISTED STEERING

The next generation Electric Power Assisted Steering (EPAS) offers outstanding feedback, control and immediate power assistance. Allowing sophisticated computer management to adapt the levels of steering support, EPAS gives you fine control at speed and comprehensive assistance during slow maneuvering. It also enables advanced optional driver assistance features such as Lane Keep Assist and Park Assist⁵.

ADAPTIVE DYNAMICS

Whether you're accelerating on the motorway, cornering on country roads or navigating around town, optional Adaptive Dynamics modifies the response to match the conditions and your driving style. It analyzes acceleration, cornering, throttle and brake pedal activity, as well as kick-down activation. Steering and body movement are also analyzed up to 500 times a second. Using this information, electronically controlled adaptive dampers then constantly adjust the suspension settings and maintain the poise and comfort⁵ of the XE.

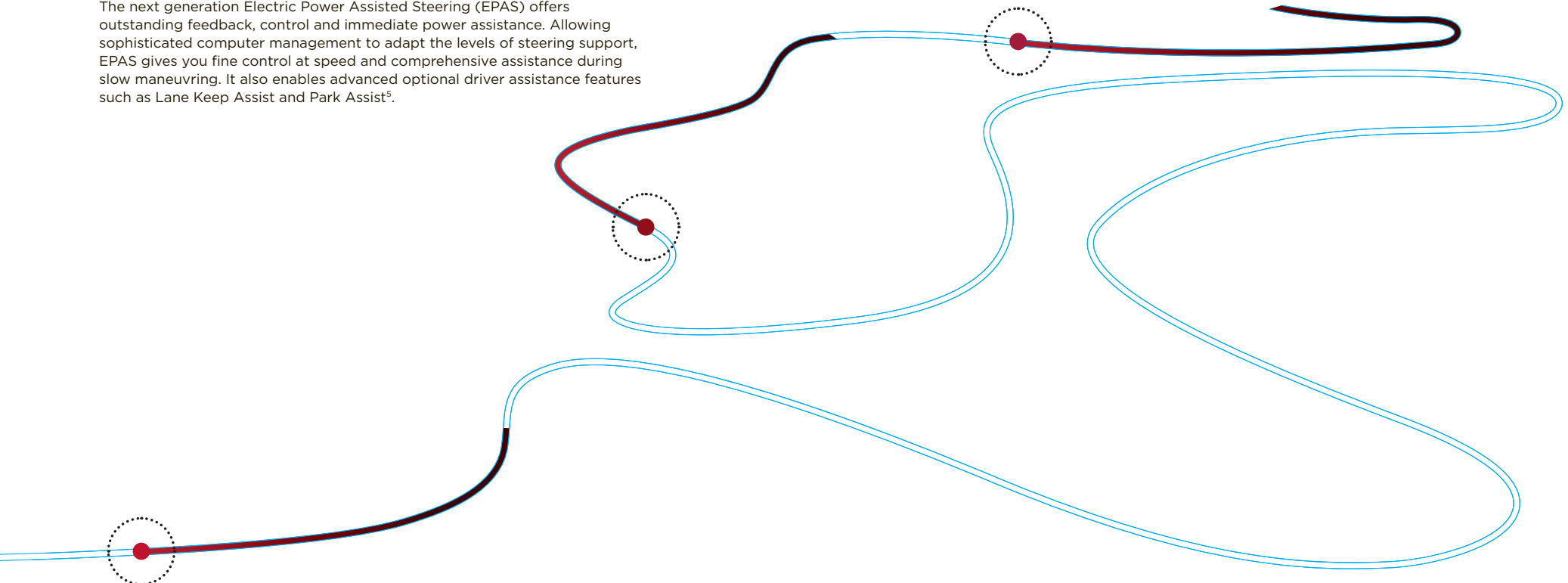

NEXT GENERATION BRAKING

The next generation braking system is optimized for high performance and to save weight. Air deflectors fitted to the front suspension efficiently channel air to cool the brakes and reduce the risk of fade during enthusiastic driving. While new technology in the pads reduces dust to improve refinement, increase disc life and maintain the clean appearance of the wheels.

Disclaimers apply. Please see page 90 for further details.

ALL SURFACE PROGRESS CONTROL

ADDED DRIVER ASSISTANCE

All Surface Progress Control (ASPC) developed by Jaguar is a low speed cruise control that helps the XE to cope with low traction situations. ASPC allows the driver to concentrate more on steering the vehicle. Once activated, you use the cruise control buttons to set a 'target' speed of between 2.2 mph and 18.6 mph. The system then works to achieve and maintain that speed while exerting traction control. ASPC is standard and gives the XE drivers added assistance over slippery, loose or icy surfaces, undulating terrain and even while descending a difficult incline. It helps make the XE easy to drive in challenging conditions. ASPC also has a pull-away function allowing the XE to progress from rest on slippery surfaces and ascending gradients, as well as a hill descent function that controls vehicle speed on steeper inclines⁵.

Fitting All Season or Winter tires to the XE can improve capability on slippery surfaces. Disclaimers apply. Please see page 90 for further details.



MUD/GRAVEL



WET GRASS



SNOW/ICE



WET ROAD

DRY ROAD CONDITIONS

In normal driving conditions, virtually all torque is distributed to the rear wheels providing signature Jaguar Rear Wheel Drive performance.

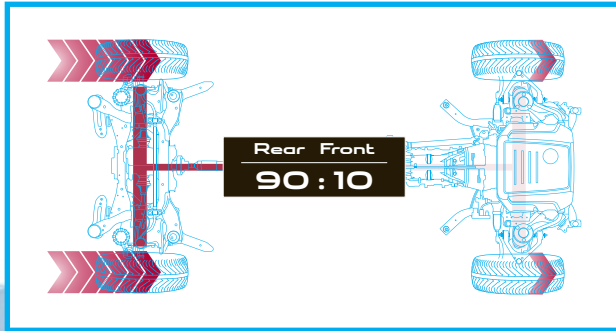

LOW TRACTION CONDITIONS

On slippery surfaces, such as grass and mud, torque can be balanced 50:50 between the front and rear wheels to maximize traction.

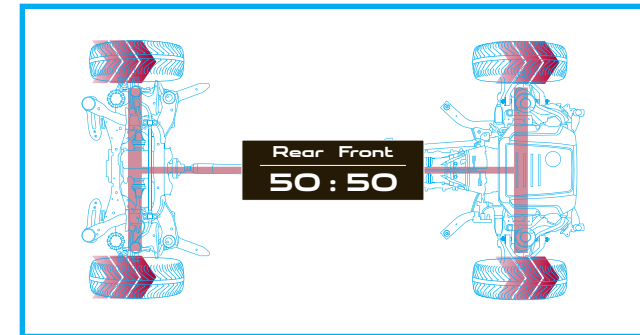

VARIABLE ROAD CONDITIONS

Where road conditions are changeable, over 90 percent of torque can be intelligently distributed from the rear wheels to the front to optimize traction in all conditions.

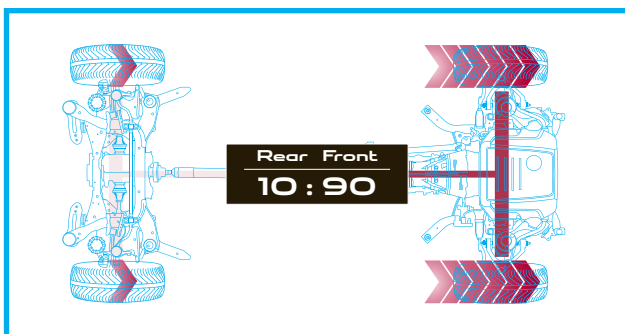

ADVANCED DRIVETRAIN TECHNOLOGY



ALL WHEEL DRIVE

ADAPTIVE SURFACE RESPONSE

The XE All Wheel Drive (AWD) system delivers confident handling on most surfaces. The drivetrain technology offers a reduction in weight and an increase in efficiency compared to previous generation systems. At its heart is an extremely fast-reacting, compact transfer case with integrated Intelligent Driveline Dynamics (IDD) software. Developed by Jaguar, the unique IDD software features sophisticated algorithms designed to react intelligently to road conditions for traction on demand. Whenever greater traction is needed, IDD ensures that precisely the right amount of torque is transferred to the front wheels - a process that takes no more than 165 milliseconds⁵. Offering a smoother, drive, the system also consumes less fuel and has lower emissions than permanent AWD. Predictive, as well as reactive, the system helps prevent you from losing traction instead of working to regain it.

On AWD vehicles fitted with Adaptive Dynamics, optional Adaptive Surface Response (AdSR) recognizes differences between surfaces to exploit the maximum available grip. Drawing on the unrivalled expertise of Jaguar Land Rover AWD systems, AdSR constantly monitors the car's environment and adjusts the appropriate engine and brake settings. Once selected, AdSR works at all speeds to support you in adverse weather and across most challenging surfaces⁵.



TORQUE VECTORING APPLIES BRAKE PRESSURE TO SLOW THE INSIDE FRONT AND INSIDE REAR WHEELS INDEPENDENTLY.

POWER IS SUSTAINED TO MAINTAIN CONSTANT SPEED OF OUTER WHEELS.

TORQUE VECTORING



MAXIMIZED CORNERING CAPABILITY

Torque Vectoring maximizes capability through even the tightest of corners. Torque Vectoring technology provides controlled independent braking on the individual inside front and rear wheels to add to the turning forces acting on the car. In most conditions more braking pressure is applied to the rear inside wheel as this supports the most increased cornering capability, while the front inside wheel is braked for greater effectiveness and refinement. The result is reduced understeer for sharper turning and more consistent road holding. Torque Vectoring delivers increased sports car-like agility and added driver confidence⁵.

ADDITIONAL ROTATIONAL FORCE APPLIED AROUND VEHICLE'S AXIS.

VEHICLE SHOWN: XE R-SPORT IN ITALIAN RACING RED WITH OPTIONAL FEATURES FITTED
Disclaimers apply. Please see page 90 for further details.

STABILITY AND CONTROL



DYNAMIC STABILITY CONTROL

ENGINE DRAG TORQUE CONTROL

The stability systems keep the XE balanced whether you're driving enthusiastically or simply want some reassurance in challenging conditions.

Dynamic Stability Control (DSC) monitors the dynamic behavior of the XE, intervening to assist vehicle stability and optimizing available grip. DSC reduces engine torque and applies braking to the appropriate wheels to correct the car's direction of travel by counteracting understeer or oversteer. The XE DSC system has enhanced understeer control to reduce speed and regain control more effectively.

Engine Drag Torque Control (EDC) mitigates the chance of wheel slip caused by strong engine braking in adverse driving conditions. It acts by briefly increasing torque to the wheels as appropriate.

UNDERSTEER

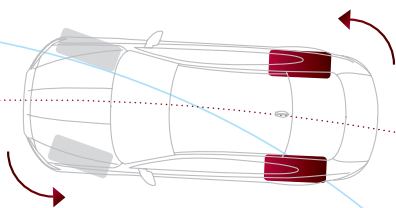
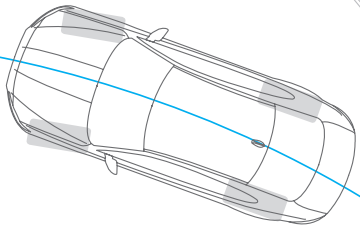
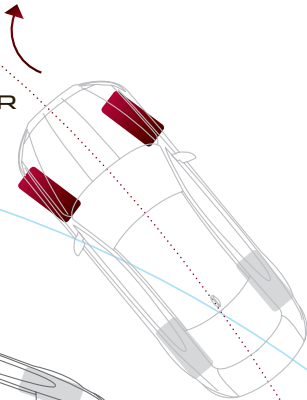

OVERSTEER

BRAKING APPLIED TO APPROPRIATE WHEELS TO COUNTERACT UNDERSTEER/OVERSTEER

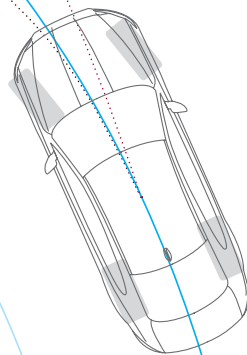

VEHICLE SHOWN: XE R-SPORT IN ITALIAN RACING RED WITH OPTIONAL FEATURES FITTED
Disclaimers apply. Please see page 90 for further details.



402 KBS

JAGUAR

XE

35t



HEAD-UP DISPLAY

➤ HEAD-UP DISPLAY WITH LASER TECHNOLOGY

The optional Head-Up Display (HUD) with laser technology projects key information onto the windshield. Remaining clear even in direct sunlight, the crisp, bright image can display vehicle speed, navigation, cruise control notifications and Traffic Sign Recognition data, where available. This technology helps you minimize time spent looking down at the instrument cluster and can help you maintain continuous awareness of your speed⁵.

ADAPTIVE CRUISE CONTROL

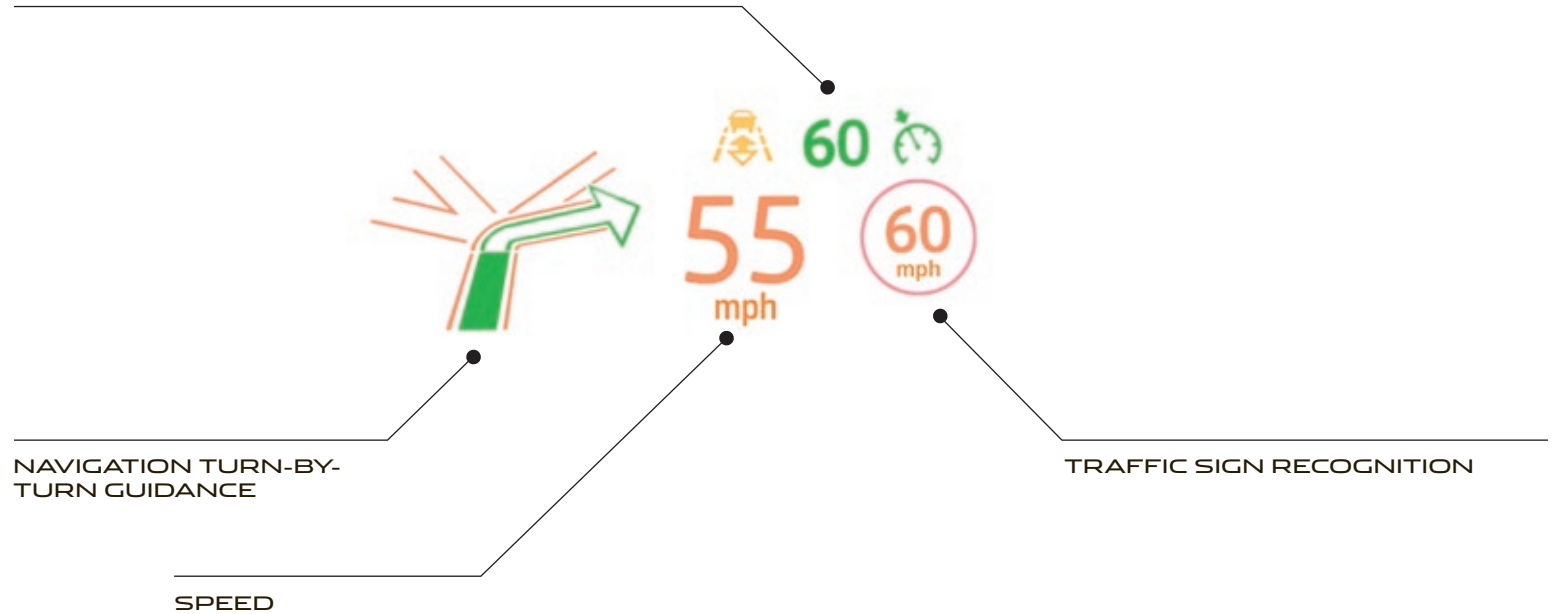

Disclaimers apply. Please see page 90 for further details.

INFOTAINMENT
JAGUAR INCONTROL® TECHNOLOGIES

 INCONTROL TOUCH™ | INCONTROL TOUCH PRO™

Jaguar InControl® is our suite of advanced technologies that links both you and your XE to the wider world. Choose from two InControl™ infotainment systems: InControl Touch™, available as standard, or upgrade to InControl Touch Pro™.

Third Party programs or applications may require an end user license from the supplier.
Do not use Jaguar InControl® features under conditions that will affect your safety or the safety of others. Driving while distracted can result in loss of vehicle control.
The Wi-Fi hotspot is intended for passenger use only. InControl® features may require an additional subscription with separate terms and conditions.



INCONTROL TOUCH™



STANDARD ON EVERY XE

8 inch Touch-screen
 5 inch instrument panel display with analog dials
 Meridian™ Sound System (380W)
 HD Digital Radio, iPod®, USB, Bluetooth® and AUX connections



InControl Remote & Protect™ consists of
 SOS Emergency Call, Jaguar Optimized Assistance,
 Stolen Vehicle Locator and Remote smartphone app

OPTIONAL FEATURES

InControl Touch™ SD Navigation
 InControl Apps™
 InControl Wi-Fi™
 SiriusXM® Satellite Radio



INCONTROL TOUCH PRO™



AVAILABLE AS AN UPGRADE

10.2 inch Touch-screen with multi-touch gestures
 and customizable homescreen
 InControl Touch Pro™ Solid State Drive (SSD) Enhanced Navigation
 Meridian™ Surround Sound System (825W)
 HD Digital iPod®, Bluetooth®
 and 2 x USB connections
 CD/DVD Drive



InControl Remote & Protect™ consists of
 SOS Emergency Call, Jaguar Optimized Assistance,
 Stolen Vehicle Locator and Remote smartphone app

Connected Navigation consists of InControl Apps™
 and InControl Wi-Fi™



8 INCH TOUCH-SCREEN SHOWN AT ACTUAL SIZE

Audio	Meridian™ Sound System (380W)
Display	5 inch instrument panel display with analog dials
Multimedia	HD Digital Radio, iPod®, USB, Bluetooth® and AUX connections
InControl Touch™ Package	InControl Remote & Protect™ consists of SOS Emergency Call, Jaguar Optimized Assistance, Stolen Vehicle Locator and Remote smartphone app
Optional Features	InControl Touch™ SD Navigation, InControl Apps™, InControl Wi-Fi™ and SiriusXM® Satellite Radio

Do not use Jaguar InControl® features under conditions that will affect your safety or the safety of others. Driving while distracted can result in loss of vehicle control. The Wi-Fi hotspot is intended for passenger use only. InControl® features may require an additional subscription with separate terms and conditions.

INCONTROL TOUCH™



ADVANCED INFOTAINMENT AS STANDARD

The InControl Touch™ multimedia system is the hub for connectivity, control and entertainment. The key features are:

8 inch Touch-screen at the heart of the center console. Clear and responsive graphical interface for quick control. Easy to use Touch-screen responds directly to touch and swipe gestures.

Bluetooth phone connectivity allows you to link and control your smartphone via InControl Touch™ either for phone calls or music playback: simple, easy and wire-free.

Access a world of music thanks to HD Digital Radio and available SiriusXM® Satellite Radio, as well as iPod, USB and AUX connections.

Integrated text-to-voice technology reduces distraction by reading out incoming text messages. You can easily respond with short, prepared messages.

Precise climate control is available via the Touch-screen. Adjust temperature levels, direction and intensity of airflow and operate heated or cooled seats (if fitted).

InControl Remote™ is a multi-function app that allows you to monitor as well as interact with your XF from your smartphone. Remote start the engine to pre-condition the climate, lock and unlock the car, locate your XF on a map or by using the beep and flash function, and track your journeys – all via the app.

InControl Protect™ includes SOS Emergency Call and optimized Roadside Assistance, which can automatically bring the relevant services to your exact location when needed.



OPTIONAL FEATURES

Enhance the capabilities of the InControl Touch™ multimedia system by selecting from the following options:

InControl Touch™ SD Navigation makes planning journeys and following routes easy, thanks to turn-by-turn voice guidance, intersection views and 3D maps.

InControl Apps™ features a range of Jaguar approved apps that can be connected to the car from your smartphone. It ensures the safe and convenient use of these apps that have been optimized specifically to enhance aspects of your in-car experience.

InControl Wi-Fi™ gives you the option to create a 3G hotspot using the car antenna when you fit a SIM card. This strengthens your link to the outside world, for a more stable connection than an individual device could maintain. Connect up to eight devices to read emails, browse the web and download content.



Explore Jaguar InControl® at JAGUARUSA.COM

Please consult your local Jaguar Retailer for further details. Certain features require the fitment of a SIM with a suitable data contract.



10.2 INCH TOUCH-SCREEN SHOWN AT ACTUAL SIZE

Audio	Meridian™ Surround Sound System (825W)
Navigation Guidance	InControl Touch Pro™ SSD Enhanced Navigation
Display	5 inch instrument panel display with analog dials
Multimedia	iPod®, Bluetooth®, HDMI, 2 x USB connections, and CD/DVD Drive
InControl Touch Pro™ Package	<p>InControl Remote & Protect™ consists of SOS Emergency Call, Jaguar Optimized Assistance, Stolen Vehicle Locator and Remote smartphone app.</p> <p>Connected Navigation consists of InControl Apps™, InControl Wi-Fi™. Additional services include Route Planner Companion App, share your destination and ETA, Commute Mode, Arrival Mode, real time traffic information and fuel and parking services.</p>

Do not use Jaguar InControl® features under conditions that will affect your safety or the safety of others. Driving while distracted can result in loss of vehicle control. The Wi-Fi hotspot is intended for passenger use only. InControl® features may require an additional subscription with separate terms and conditions.

INCONTROL TOUCH PRO™

UPGRADE TO NEXT GENERATION INFOTAINMENT

The next-generation hardware and software of InControl Touch Pro™ advances your vehicle's connectivity and entertainment to the very highest level. InControl Touch Pro™ features replace or enhance those found in InControl Touch™. The key aspects of InControl Touch Pro™ are:

Larger, highly-responsive, 10.2 inch Touch-screen at the heart of the center console with customizable home screen and lightning fast response times. Its interactive side panel makes multi-tasking easy.

Pinpoint touch control allows you to manipulate and interact with information swiftly and seamlessly. The Touch-screen responds in the same manner as a smartphone or tablet computer, providing multi-touch gestures such as pinch to zoom and swipe.

Solid State Drive Enhanced Navigation with response times that are a fraction of conventional systems'. One of the many innovative features of InControl Touch Pro™ Navigation is that it allows you to set a destination and the system alerts you if you have insufficient fuel for the journey. It then displays gas stations on the part of the route where you may be low on fuel. The system automatically displays parking options.

ENHANCED CONNECTIVITY

The services, technologies and applications found within Connected Navigation provide you with the very best in connectivity and convenience. It offers many features including:

Route Planner Companion App offers true door-to-door navigation. Pre-plan your destination and route via your Apple or Android smartphone. The app will guide you to your car, where you will find your selected route available on the car's Touch-screen. When you've completed your road journey, the app can guide you by foot or public transport (where supported) to your destination.

Share your estimated time of arrival so your selected contact(s) will know exactly when you will arrive, as calculated by the navigation guidance system. If you're running late, the system can then send automatic updates via text or email, without any further action from you.

Commute Mode allows the system to learn your commutes and automatically advises you of the expected journey time based on live and historical traffic movements. The system learns the routes you take for a given destination and then advises which of those is the quickest.

Arrival Mode displays interactive 360 degree street level imagery of your destination for seamless finishes to journeys. It automatically displays again upon your arrival. You can simply tap the Touch-screen to select a nearby parking spot, which appears as an updated destination.

 Explore Jaguar InControl® at JAGUARUSA.COM

Please consult your local Jaguar Retailer for further details. Certain features require the fitment of a SIM with a suitable data contract.

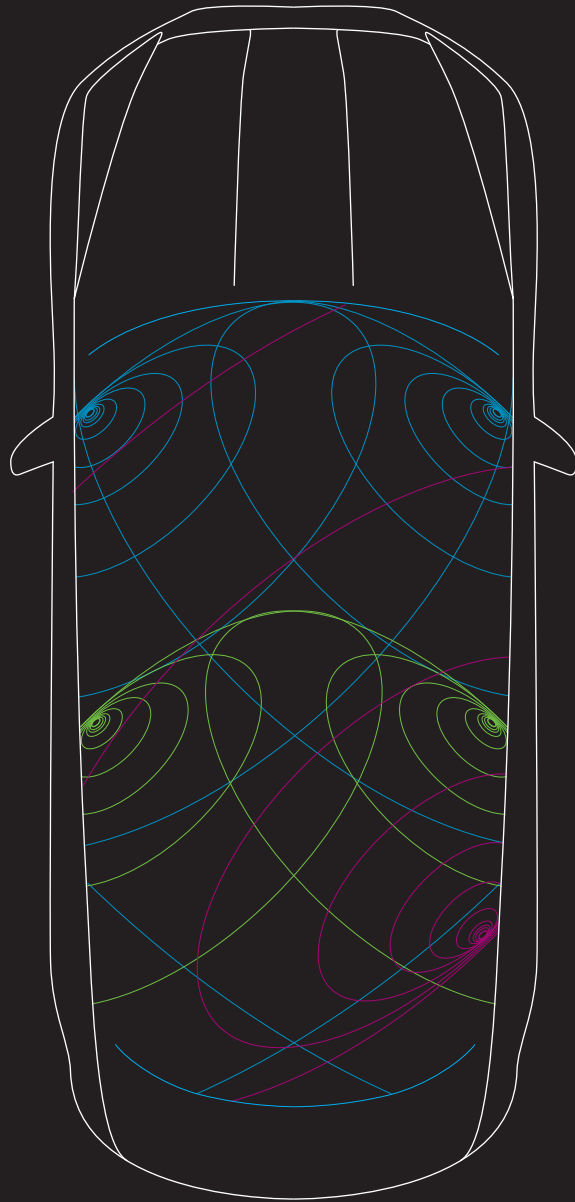

AUDIO



JAGUAR
SOUND SYSTEM

MERIDIAN™
SOUND SYSTEM

The superb sound systems bring your music to life. Offering an enhanced listening experience are the Jaguar Sound System and the Meridian Sound System 380W with 11 speakers. Designed in conjunction with the British audio experts Meridian, these systems use innovative audio technology and precise speaker placement to give perfectly optimized sound quality.

All systems ensure that, wherever you or your passengers sit in your XE, everyone will enjoy a rich, enveloping audio experience.



-  Fresh air subwoofer
-  Front door waves tweeter midrange bass
-  Rear door waves tweeter midrange

Diagram representative of Meridian 380W Sound System.



MERIDIAN

SOUND SYSTEMS AVAILABLE IN CONJUNCTION WITH **INCONTROL TOUCH™**

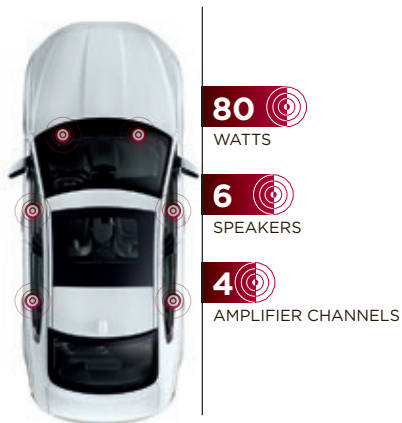

JAGUAR SOUND SYSTEM

Speed Dependent Volume**
80 watts
6 speakers
4 amplifier channels

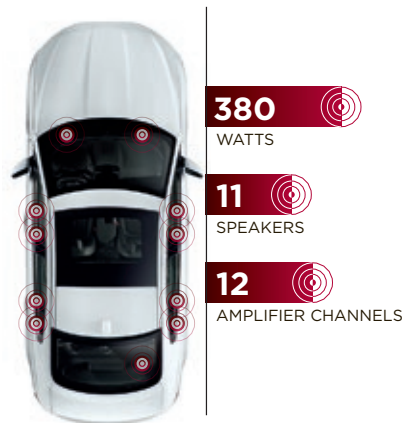

MERIDIAN SOUND SYSTEM*

Speed Dependent Volume**
380 watts
11 speakers including sub woofer
12 amplifier channels

SOUND SYSTEM AVAILABLE IN CONJUNCTION WITH **INCONTROL TOUCH PRO™**

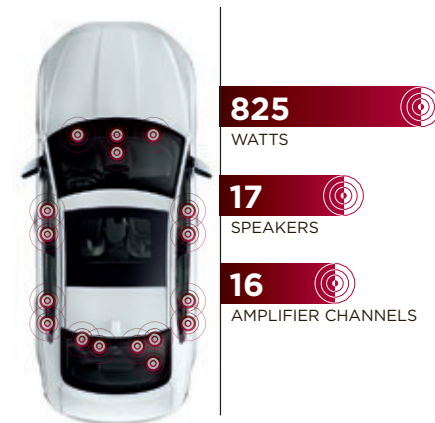

MERIDIAN SURROUND SOUND SYSTEM

DSP amplifier
Audyssey MultEQ Audio Equalisation
Dynamic Volume Control*
825 watts
17 speakers
16 amplifier channels

*Standard feature on Premium, Prestige & R-Sport derivatives.

**Automatically adjusts as vehicle speed changes.

*Automatically adjusts as vehicle speed changes and/or ambient noise levels change.

VEHICLE SHOWN: XE PRESTIGE IN GLACIER WHITE WITH OPTIONAL FEATURES FITTED

ASSISTANCE AND EFFICIENCY

ADVANCED DRIVER ASSISTANCE



1 AUTONOMOUS EMERGENCY BRAKING*

Should a potential collision be detected, the XE gives an audible forward collision warning. Visual warnings follow. If the driver takes no action, the system applies the brakes to help reduce the severity of the possible impact, when driving below 50 mph.

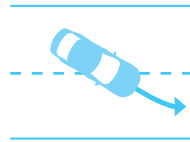

2 LANE DEPARTURE WARNING*

Lane Departure Warning (LDW) notifies the driver with a visual alert and a gentle vibration of the steering wheel should the car detect an unintentional drift from its lane, helping to keep everyone on board safe.



3 LANE KEEP ASSIST AND DRIVER CONDITION MONITOR**

Lane Keep Assist (LKA) senses unintentional lane drift and helps steer the XE back into its lane. Driver Condition Monitor (DCM) detects lapses in concentration due to tiredness by monitoring driver inputs and suggests taking a break via an audible alert and a visual notification in the instrument cluster.



4 TRAFFIC SIGN RECOGNITION AND ADAPTIVE SPEED LIMITER**

Traffic Sign Recognition technology detects speed limits, including variable limits, and no passing signs via the forward-facing camera, then displays them to the driver. The Adaptive Speed Limiter uses detected traffic sign information to help keep the XE within the appropriate speed limit. Where no traffic sign is detected, the Adaptive Speed Limiter can also use the map data from the optional navigation system.



5 BLIND SPOT MONITOR AND REVERSE TRAFFIC DETECTION**

Blind Spot Monitor alerts you to vehicles or obstacles beside the XE, as well as ones approaching from a distance behind, via an icon displayed in the appropriate exterior mirror. Reverse Traffic Detection extends the Blind Spot Monitor function and alerts you via the Touch-screen of moving vehicles during reversing - for example, when leaving a parking space with restricted vision.



6 PARK ASSIST**

Park Assist makes parking in tight spaces easier than ever. The XE can accurately steer itself during both parallel and perpendicular parking maneuvers - the driver only has to control the brakes and accelerator. An exit-assist function can help guide the XE while leaving a parallel space.

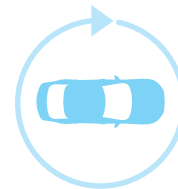

7 SURROUND CAMERA SYSTEM**

Surround Camera System gives you 360° exterior vision on the Touch-screen. This helps with various maneuvers from parking by a curb to getting in and out of tight spaces.

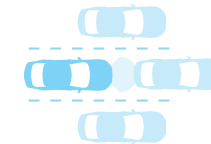

8 ADAPTIVE CRUISE CONTROL WITH QUEUE ASSIST**

Adaptive Cruise Control uses radar technology to automatically adjust your speed to maintain a safe distance from the vehicle ahead. If that vehicle slows, your XE reduces its speed to maintain a set distance. The XE resumes its pre-set speed as soon as the road in front is clear. Should the car in front stop completely, the Queue Assist function brings the XE to a smooth halt. Once the traffic moves off, touch the accelerator and the XE will follow the car in front again.

*Standard feature.
**Optional feature.

These features are not a substitute for driving safely with due care and attention and will not function under all circumstances, speeds, weather and road conditions, etc. Driver should not assume that these features will correct errors of judgment in driving. Please consult the owner's manual or your local Jaguar Retailer for more details.

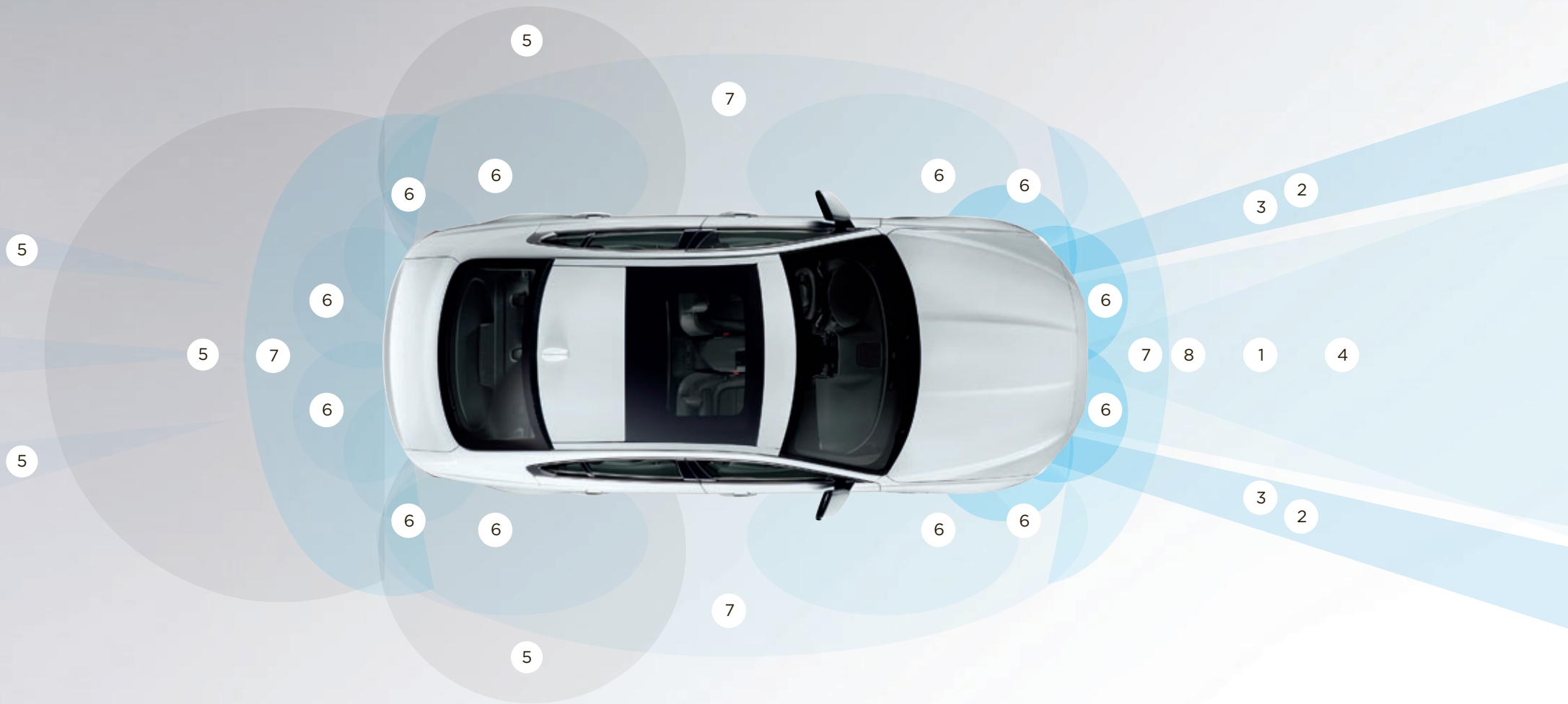

VEHICLE SHOWN: XE PRESTIGE IN GLACIER WHITE WITH OPTIONAL FEATURES FITTED

EFFICIENT TECHNOLOGIES

 **STOP/START TECHNOLOGY** | **CLEAN TECHNOLOGIES**

Everyone wants to do more with less. That is why the XE uses a range of technologies to reduce fuel consumption and CO₂ emissions, all while staying true to the dynamic nature of Jaguar.



STOP/START TECHNOLOGY

The XE engines come with Stop/Start. It shuts down the engine when you come to a complete halt and restarts the engine immediately when required to help save fuel, especially during city driving.



ADVANCED AERODYNAMICS

The XE can offers low drag co-efficient of Cd 0.28. This helps the XE cut through the air with ease, meaning less work for the engine and therefore reduced fuel consumption and emissions.

AdBlue®

ADBLUE®

The diesel models are fitted with AdBlue® to help clean exhaust gases. AdBlue® is a non-toxic, non-flammable, biodegradable additive that cleanses the gases in the car's exhaust system to remove harmful nitrogen oxide emissions.



LOW FRICTION TECHNOLOGIES

Technologies such as smart coatings on pistons and needle roller bearings in the Ingenium engine range help to reduce friction, particularly at low engine temperatures. This helps the car perform at its efficient best.

PERSONALIZATION THE XE - YOUR CHOICE

 Configure your vehicle at JAGUARUSA.COM



1 CHOOSE YOUR ENGINE

Page 54

Select one of the powerful, efficient gas or diesel engines to suit your driving style.

2 CHOOSE YOUR MODEL & PACKAGES

Page 56

Compare the wealth of standard features and options on XE models.

3 CHOOSE YOUR COLOR

Page 64

Express your individuality with one of the stunning exterior colors available on the XE.

CHOOSE YOUR WHEELS

Page 66

Add the personal finishing touch to your new XE, and complement its stunning style, with a set of beautifully designed alloy wheels.

CHOOSE YOUR INTERIOR

Page 68

There's a wide selection of premium materials, leathers, veneers and finishes for every personal taste.

CHOOSE YOUR JAGUAR ACCESSORIES

Page 78

Really make it yours by adding style, practicality and versatility with official XE Accessories from your local Jaguar Retailer.

1 CHOOSE YOUR ENGINE

 Configure your vehicle at JAGUARUSA.COM

> DIESEL ENGINES

2.0 LITER 4-CYLINDER TURBOCHARGED

MAXIMUM POWER 180HP
MAXIMUM TORQUE 318 lb-ft
ACCELERATION 0-60 mph 7.4 seconds
TOP SPEED 120 mph
COMBINED MPG TBD*
XE, PREMIUM, PRESTIGE, R-SPORT

2.0 LITER 4-CYLINDER AWD TURBOCHARGED

MAXIMUM POWER 180HP
MAXIMUM TORQUE 318 lb-ft
ACCELERATION 0-60 mph 7.5 seconds
TOP SPEED 120 mph
COMBINED MPG TBD*
XE, PREMIUM, PRESTIGE, R-SPORT

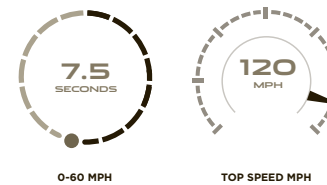
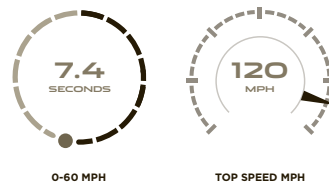

*EPA estimates not available at time of publication. See your local Jaguar Retailer for updated EPA estimates. Always follow local speed limits.

GAS ENGINES

2.0 LITER 4-CYLINDER TURBOCHARGED

MAXIMUM POWER 240HP

MAXIMUM TORQUE 251 lb-ft

ACCELERATION 0-60 mph 6.5 seconds

TOP SPEED 120 mph

COMBINED MPG TBD*

XE, PREMIUM, PRESTIGE

3.0 LITER V6 SUPERCHARGED

MAXIMUM POWER 340HP

MAXIMUM TORQUE 332 lb-ft

ACCELERATION 0-60 mph 5.1 seconds

TOP SPEED 120 mph

COMBINED MPG TBD*

PREMIUM, PRESTIGE, R-SPORT

3.0 LITER V6 AWD SUPERCHARGED

MAXIMUM POWER 340HP

MAXIMUM TORQUE 332 lb-ft

ACCELERATION 0-60 mph 5.1 seconds

TOP SPEED 120 mph

COMBINED MPG TBD*

PREMIUM, PRESTIGE, R-SPORT



0-60 MPH

TOP SPEED MPH



0-60 MPH

TOP SPEED MPH



0-60 MPH

TOP SPEED MPH

2 CHOOSE YOUR MODEL & PACKAGES

 Configure your vehicle at JAGUARUSA.COM

LUXURY



XE

KEY FEATURES

- 17" alloy wheels
- Halogen Headlamps with daytime running lamps
- Luxtec seats
- 10-way front seats (8-way electric)
- Gloss Black finisher
- All Surface Progress Control⁵
- Electric tilt and slide glass moonroof
- Jaguar 80W Sound System with 6 speakers
- Chrome window surround with black waist finisher



PREMIUM

KEY FEATURES (IN ADDITION TO XE)

- 18" alloy wheels*
- Rear camera parking aid⁵
- Meridian 380W sound system
- Memory function with 2 settings for driver's seat and exterior mirrors
- Exterior mirrors - body color, powerfolding, electrically adjustable, heated, electrochromic, memory with puddle lamps and clear side turn indicators
- Passenger side exterior mirror - dip in reverse
- HomeLink System[®]



PRESTIGE

KEY FEATURES (IN ADDITION TO PREMIUM)

- 18" alloy wheels** / 19" alloy wheels*
- Taurus Leather seats
- Front Seats 4-Way power lumbar
- Heated front seats
- Bright Chrome window surrounds
- Dark Satin Brushed Aluminum finisher
- Softgrain heated leather steering wheel
- Navigation system²
- Keyless Entry
- Power steering column with memory

Images feature optional equipment. Please note that standard features may be replaced when selecting alternative trim levels.

*Available on 3.0 liter V6 gas derivative only.

**Available on 2.0 liter 4 cylinder gas/diesel derivative only.

Disclaimers apply. Please see page 90 for further details.

> SPORT



R-SPORT

KEY FEATURES (IN ADDITION TO PRESTIGE)

Sports Taurus Leather seats

R-Sport branded Multi-Function Softgrain Leather steering wheel

Black radiator grille with Satin Chrome surround

Etched Aluminum trim finishers

R-Sport bodykit - R-Sport front bumper, Body-coloured extended side sills, Satin Chrome side power vents with R-Sport Badge and trunklid Spoiler

Metal treadplates with R-Sport branding

Sports suspension

Adaptive Bi-funtion Xenon headlamps with LED 'J' Blade

Daytime Running Lamps and Auto High Beam Assist (AHBA)⁵

Lane Departure Warning, Lane Keep Assist, Driver Condition Monitor⁵

Blind Spot Monitor⁵

Front and Rear Parking Aids⁵

Autonomous Emergency Braking

2 CHOOSE YOUR MODEL & PACKAGES

 Configure your vehicle at JAGUARUSA.COM

KEY STANDARD & OPTIONAL FEATURES

	XE	PREMIUM	PRESTIGE	R-SPORT
TRANSMISSION, STEERING & DYNAMIC FEATURES				
8-Speed ZF electronic automatic transmission	●	●	●	●
Power-assisted, speed sensitive, variable ratio, rack and pinion steering	●	●	●	●
Electric Power-Assist Power Steering (EPAS) ⁵	●	●	●	●
Torque Vectoring by Braking (TVBB) ⁵	●	●	●	●
Hill Launch Assist ⁵	●	●	●	●
All Surface Progress Control (ASPC) ⁵	●	●	●	●
Steering wheel mounted shift paddles	●	●	●	●
JaguarDrive Control™				
Normal, Eco & Dynamic Modes ⁵	●	●	●	●
Rain/Ice/Snow Mode ⁵	●	●	●	●
JaguarDrive Selector™ rotary gear selector	●	●	●	●
SUSPENSION				
Four-wheel independent suspension	●	●	●	●
Double wishbone front suspension architecture	●	●	●	●
Integral link rear suspension	●	●	●	●
Adaptive dynamics ⁵	—	—	○	○
BRAKES & STABILITY CONTROL				
Anti-Lock Braking System (ABS)	●	●	●	●
Cornering brake control (CBC) ⁵	●	●	●	●
Dynamic Stability Control (DSC) with TracDSC mode ⁵	●	●	●	●
Electric Parking Brake (EPB) with drive away release ⁵	●	●	●	●
Hazard lights under heavy braking	●	●	●	●
Alloy space saver spare wheel	●	●	●	●

SAFETY & SECURITY

	XE	PREMIUM	PRESTIGE	R-SPORT
SAFETY				
Passive front head restraints (whiplash reduction system)	●	●	●	●
Belt-minder system with audio reminder chime and flashing warning light engages if vehicle is moving more than 10 mph and safety belt is not buckled on occupied front or rear seats	●	●	●	●
Driver and Front passenger safety belt pretensioners	●	●	●	●
ISOFIX Child seat tethered-anchorage	●	●	●	●
Dual-stage front airbags and seat-mounted side airbags ⁶ for front occupants	●	●	●	●
Full length side-impact curtain airbags for front and rear ⁶	●	●	●	●
Three-point restraints at all seating positions	●	●	●	●
Tire Pressure Monitoring System (TPMS)	●	●	●	●
SECURITY				
Antitheft engine immobilizer	●	●	●	●
Drive away locking	●	●	●	●
Security system with perimeter alarm	●	●	●	●
Emergency phosphorescent release in trunk	●	●	●	●
Brake pad wear indicator	●	●	●	●
Hazard lights under heavy braking	●	●	●	●
LOCKING				
2-stage unlock, Touch screen programmable	●	●	●	●
Central locking with drive-away door locking (touch screen programmable)	●	●	●	●
Jaguar Smart Key System™ with emergency key - provide remote locking/unlocking, access to trunk and activate panic alarm	●	●	●	●
Keyless entry	—	—	●	●
Trunk lid - Power open/close (with safety sensing)	—	—	P3	P3
Power operated child locks	●	●	●	●
Global window close from exterior lock button	●	●	●	●
Valet function for glove box and trunk security	●	●	●	●

● Standard ○ Optional — Not available

P1 Cold Climate Package P2 Vision Package P3 Comfort & Convenience Package P4 Driver Assistance Package

P5 Black Design Package P6 Technology Package

Disclaimers apply. Please see page 90 for further details.

DRIVERS AIDS⁵

	XE	PREMIUM	PRESTIGE	R-SPORT
Cruise control	●	●	●	●
Automatic Speed Limiter (ASL)	●	●	●	●
Blind Spot Monitor with Closing Vehicle Sensing and Reverse Traffic Detection	—	P2	P2	●
Rear View Camera parking aid with guidance lines on display	○	●	●	●
Rear Parking Aid sensors with Touch-screen visual indicators	—	P2	P2	●
Front Parking Aid sensors with Touch-screen visual indicators	—	P2	P2	●
Surround Camera System – 4 cameras for front, side & rear views with images shown on the Touch Screen	—	—	—	P4
Park Assist – Parallel & Perpendicular Parking plus Parking Exit	—	—	—	P4
360° Parking Aid – additional sensors to alert the driver to potential side impacts	—	—	—	P4
Traffic Sign Recognition & Intelligent Speed Limiter (ISL)	—	—	—	P4
Adaptive Cruise Control (ACC) with Forward Alert, Queue Assist, Intelligent Emergency Braking and Follow Mode off	—	—	—	P4
Autonomous Emergency Braking (uses forward facing camera)	—	—	—	●
Lane Departure Warning, Lane Keep Assist, and Driver Condition Monitor	—	—	—	●
Head-up Display	—	—	○	○

CONVENIENCE FEATURES

	XE	PREMIUM	PRESTIGE	R-SPORT
Approach illumination	●	●	●	●
Dual function trip computer in Driver message center	●	●	●	●
Outside temperature gauge	●	●	●	●
Glove box, lockable	●	●	●	●
HomeLink System* – compatible three-channel garage-door/entry-gate opener	—	●	●	●
Keyless push button start	●	●	●	●
Rain-sensing, variable intermittent dual wipers	●	●	●	●
Shopping bag hook in trunk	●	●	●	●
Trunk lid – Power open/close (with safety sensing)	—	—	P3	P3
Sunglasses Holder in Overhead Console	●	●	●	●
Twin front cup holders plus auxiliary power socket in center console	●	●	●	●
Twin rear cup holders	●	●	●	●
12V Power sockets – located in rear and in trunk	●	●	●	●

2 CHOOSE YOUR MODEL & PACKS

 Configure your vehicle at JAGUARUSA.COM

EXTERIOR FEATURES

BODY EXTERIOR APPEARANCE

	XE	PREMIUM	PRESTIGE	R-SPORT
Bumpers - Body colored	●	●	●	●
Exhaust tips	●	●	●	●
Front Grille	Grained Black mesh insert with Chrome surround	●	●	—
	Grained Black mesh insert with Satin Chrome surround	—	—	●
	Gloss Black mesh insert with Satin Chrome surround	—	—	P4
	Gloss Black mesh insert with Gloss Black surround	—	—	P5 P5
Window Surround Finishers	Chrome surround with Black waist finisher	●	●	—
	Bright Chrome	—	—	●
	Gloss Black	—	—	P5 ●
Side Power Vents	Bright Chrome	●	●	—
	Gloss Black	—	—	P5 P5
	"R-Sport" Badge	—	—	●
Front Bumper	"R-Sport" Style bumper	—	—	●
	Gloss Black front bumper blades	—	—	P5
Side Sills - Body colored	—	—	—	●
Rear Valance - Grained Black	●	●	●	●
Rear Spoiler - Body colored, trunk mounted	—	—	—	●

EXTERIOR BADGING

	XE	PREMIUM	PRESTIGE	R-SPORT
Trunk left side - Nameplate	●	●	●	●
Center trunk lid - Jaguar and leaper wordmark	●	●	●	●
Trunk Right Side	Powertrain	●	●	●
	"AWD" with AWD models only	●	●	●
Side Power Vents	Chrome	●	●	—
	Satin Chrome with "R-Sport"	—	—	●
	Side Power Vents - Gloss Black	—	—	P5 P5

ELECTRIC GLASS MOONROOF

	XE	PREMIUM	PRESTIGE	R-SPORT
Electric with tilt/slide one touch operation and electric blind	●	●	●	●

LAMPS

	XE	PREMIUM	PRESTIGE	R-SPORT
Reflector Halogen headlamps with daytime running lamps	●	●	●	—
Adaptive Bi-function HID Xenon headlamps ⁵ with LED daytime running lamps and variable light distribution including turning lights and auto-leveling	—	P2	P2	●
LED Signature "J" blade daytime running lamps	—	P2	P2	●
Headlamp powerwash	—	P2	P2	●
Intelligent high beam ⁵	—	P2	P2	●
Partial Light Emitting Diode (LED) tail lamps	●	●	●	●

MIRRORS & WINDOWS

	XE	PREMIUM	PRESTIGE	R-SPORT
Exterior mirrors - body color, electrically adjustable, heated with clear side turn indicators	●	—	—	—
Exterior mirrors - body color, powerfolding, electrically adjustable, heated, electrochromic with puddle lamps and clear side turn indicators	—	●	●	●
Passenger side exterior mirror - dip in reverse	●	●	●	●
Heated Windshield Washer Jets	P1	P1	○	○

● Standard ○ Optional — Not available

P1 Cold Climate Package P2 Vision Package P3 Comfort & Convenience Package P4 Driver Assistance Package
P5 Black Design Package P6 Technology Package

Disclaimers apply. Please see page 90 for further details.

INTERIOR FEATURES

	XE	PREMIUM	PRESTIGE	R-SPORT
CLIMATE CONTROL				
Automatic A/C with solar sensing, mist sensing, air filtration and dual temperature control for driver and front passenger	●	●	●	●
DOOR SILL FINISHERS				
Non-Metal with Jaguar lettering	●	●	—	—
Metal with Jaguar lettering	—	—	●	—
Metal with "R-Sport" script	—	—	—	●
FOOTWELL RUGS				
Front and rear carpet mats	●	●	●	●
GEAR SELECTOR				
JaguarDrive™ Rotary Gear Selector – bright Chrome finish	●	●	●	●
INTERIOR LIGHTING				
Overhead light console with JaguarSense™ control	●	●	●	●
Phosphor blue ambient interior lighting	●	●	—	—
Interior Lighting – Switchgear & ICP lighting, front map lights, trunk illumination and front & rear downlighters	●	●	—	—
Driver and front passenger Sun visors with illuminated vanity mirrors	—	—	●	●
Blue halo illumination on Front & rear door signature lines and front & rear door release	—	—	●	●
Glovebox illumination	●	●	●	●
Front footwell & rear map lights	—	—	●	●
MIRRORS & WINDOWS				
Auto-dimming interior rear view mirror	●	●	●	●
Front and rear electric windows with one-touch open/close and anti-trap	●	●	●	●
Infrared reflective front windshield glass	●	●	●	●
Heated rear window	●	●	●	●
Heated front windshield – heated with timer. Includes heated washer jets	P1	P1	○	○

WINDOW SUNBLINDS

	XE	PREMIUM	PRESTIGE	R-SPORT
Electric rear window sunblind	—	—	P3	P3

SEATING

10x10 way Front seats with 8x8 electric movement – Fore/Aft (2), Cushion Height (2) & Tilt (2), Squab Recline (2) – plus manual Headrest Height (2)	●	●	●	●
Front Seats 4-Way power lumbar	—	—	●	●
Sport-style front seats	—	—	—	●
3-stage heated front seats	P1	P1	●	●
3-stage active ventilated heated and cooled front seats	—	—	P3	P3
3-stage heated rear seats	—	—	P3	P3
Memory function with 2 settings for driver's seat, exterior mirrors and steering wheel column	—	●	●	●
Fixed rear seat	●	—	—	—
Rear-folding seat (40/20/40 split)	—	●	●	●
Rear armrest with cupholders	●	●	●	●
3 rear headrests	●	●	●	●

STEERING WHEEL & CONTROLS

Grained leather steering wheel with Jaguar Sequential Shift™ paddles and remote controls for audio, cruise control & Bluetooth® wireless technology	●	●	—	—
Soft grain leather steering wheel with Jaguar Sequential Shift™ paddles and remote controls for audio, cruise control, Bluetooth® wireless technology and JaguarVoice™	P1	P1	●	●
Heated steering wheel	P1	P1	●	●
"R-Sport" Script on Steering wheel	—	—	—	●
Power Adjustable Steering Column (reach and rake)	—	—	●	●
Three flash lane change/turn indicator	●	●	●	●

2 CHOOSE YOUR MODEL & PACKAGES

 Configure your vehicle at JAGUARUSA.COM

INTERIOR FEATURES CONTINUED

	XE	PREMIUM	PRESTIGE	R-SPORT
INTERIOR TRIM				
Front center console with storage compartment, auxiliary power socket, 3.5mm Stereo auxiliary input socket and armrest	●	●	●	●
Luxtec seat trim	●	●	—	—
Taurus leather seat trim	—	—	●	●
Sports Leatherette-wrapped instrument panel	—	—	—	●
Seat back map pocket - Net	—	—	●	●
Morzine Headliner - Oyster	●	●	●	—
Morzine Headliner - Jet	—	—	—	●
VENEER TRIM				
Gloss Black	●	●	—	—
Dark Satin Brushed Aluminum	—	—	●	—
Etched Aluminum	—	—	—	●
Satin Burl Ash	—	—	—	○
Gloss Figured Ebony	—	—	○	—
Carbon Fiber	—	—	—	○

INFORMATION, COMMUNICATION AND ENTERTAINMENT

	XE	PREMIUM	PRESTIGE	R-SPORT
MULTIMEDIA				
Physical dials with 5" full color TFT-LCD display	●	●	●	●
InControl Touch™ 8" capacitive Touch-screen display with controls for audio, climate control, Bluetooth® telephone connectivity and navigation	●	●	●	●
InControl Touch Pro™ 10.2" capacitive Touch-screen display with controls for audio, climate control, Bluetooth. telephone connectivity and navigation¹	—	—	P6	P6
ECO HMI - Includes Eco data analysis, Parasitic load monitor and Driver Eco	●	●	●	●
Voice Control²	○	○	●	●
Jaguar 80W Sound System with 6 speakers	●	—	—	—
Meridian™ 380W Sound System with 11 speakers incl 1 subwoofer	—	●	●	●
Meridian™ 825W 7.1 Channel Digital Surround Sound System plus Meridian Trifield mode, 17 speakers including 1 Sub-Woofer, separate DSP, Audyssey MultEQ and Meridian Cabin correction	—	—	P6	P6
Dynamic volume Control	●	●	●	●
HD Radio⁴	●	●	●	●
Front media interface (USB & iPod®)	●	●	●	●
SiriusXM® Satellite Radio	○	○	○	●
InControl Apps™ Enables use of optimized 3 rd party smartphone apps installed on a phone through the vehicle's Touch-screen¹	○	○	●	●
NAVIGATION				
Navigation system with SD Card-based mapping²	○	○	●	●
InControl Touch Pro™ - Navigation system with 60GB Solid State Disk (SSD) Drive-based mapping. Includes HDD-based "virtual multichanger" and single slot in dash CD/DVD player	—	—	P6	P6
Bluetooth® wireless technology for cell phone and audio streaming²	●	●	●	●
TELEMATICS				
InControl Protect™ - SOS emergency call, Jaguar Assistance Call and Stolen vehicle locator. Service complimentary for 5 years	●	●	●	●
InControl Remote™ - Smart phone application for vehicle status (fuel level, security status, last parked, direction to vehicle), vehicle lock/unlock, A/C remote setting through engine start. Feature complimentary for 5 years	●	●	●	●
InControl Wi-Fi™ - 3G hotspot - includes 3GB or 3 months (which ever comes first) complimentary data subscription	—	○	○	●

● Standard ○ Optional — Not available NCO No Cost Option

P1 Cold Climate Package P2 Vision Package P3 Comfort & Convenience Package P4 Driver Assistance Package
P5 Black Design Package P6 Technology Package

Disclaimers apply. Please see page 90 for further details.

OPTION PACKAGES

		XE	PREMIUM	PRESTIGE	R-SPORT	
	CODE					DESCRIPTION
Cold Climate Package	Z88D	○	○	—	—	Heated Front Seats, Heated Steering Wheel, Heated Front Windshield, Heated Washer Jets
Vision Package ⁵	Z86A	—	○	○	—	Bi-Functioning HID Xenon Headlamps with LED Daytime Running Lamps, Adaptive Front Lighting with Auto High Beam Assist (AHBA), Headlamp Washers, Blind Spot Monitor with Closing Vehicle Sensing, Reverse Traffic Detection, Front & Rear Parking Aids
Comfort & Convenience Package	Z28C	—	—	○	○	Cooled Front Seats, Heated Rear Seats, Electric Rear Sunblind, Trunk - Power open/close with proximity safety sensing
Driver Assistance Package ⁵	Z68X	—	—	—	○	Adaptive Cruise Control (ACC) with Forward Alert, Advanced, Emergency Brake Assist with Queue Assist, Intelligent Emergency, Braking & Follow Mode off, Surround Camera System, 360° Parking Aid, Traffic Sign Recognition & Intelligent Speed Limiter, Park Assist - Parallel, Perpendicular, & Parallel Exit
Black Design Package	Z93L	—	—	○	○	Radiator grille - Gloss Black insert with Gloss Black surround, Gloss Black Side Power Vents, Gloss Black Blades in R-Sport Front Bumper (R-Sport Only), Gloss Black Window Surround (Standard on R-Sport)
Technology Package	Z80U	—	—	○	○	InControl Touch Pro™ - SSD based Navigation with 60GB memory and single slot in dash CD/DVD player, 10" Capacitive Touch-Screen and Meridian 825W Surround Sound System

STAND ALONE OPTIONS

Heated front windshield	H74A	—	—	○	○	—
Rear View Camera ⁵	C14A	○	●	●	●	—
InControl Touch™ - SD Card-based mapping Navigation system & InControl Apps™	G61C	○	○	●	●	—
Head-up Display ⁵	G62A	—	—	○	○	Refer to page 39
SiriusXM® Satellite Radio ⁴ (includes 3 month complimentary service)	B51D	○	○	○	●	—
InControl Wi-Fi™ with 3GB or 3 month complimentary data plan (which ever comes first)	A44A	—	○	○	○	—
Adaptive dynamics ⁵ with Configurable dynamics	C35A	—	—	○	○	Configurable Dynamics not available on XE models with 2.0L Gas engine
Powertrain debadging	B05H	NCO	NCO	NCO	NCO	—

3 CHOOSE YOUR COLOR

 Configure your vehicle at [JAGUARUSA.COM](https://www.jaguarusa.com)

SOLID

Polaris White

Ebony Black

METALLIC

Glacier White

Rhodium Silver

Quartzite

Ammonite Grey

Bluefire*

Caesium Blue**

Dark Sapphire

Odyssey Red

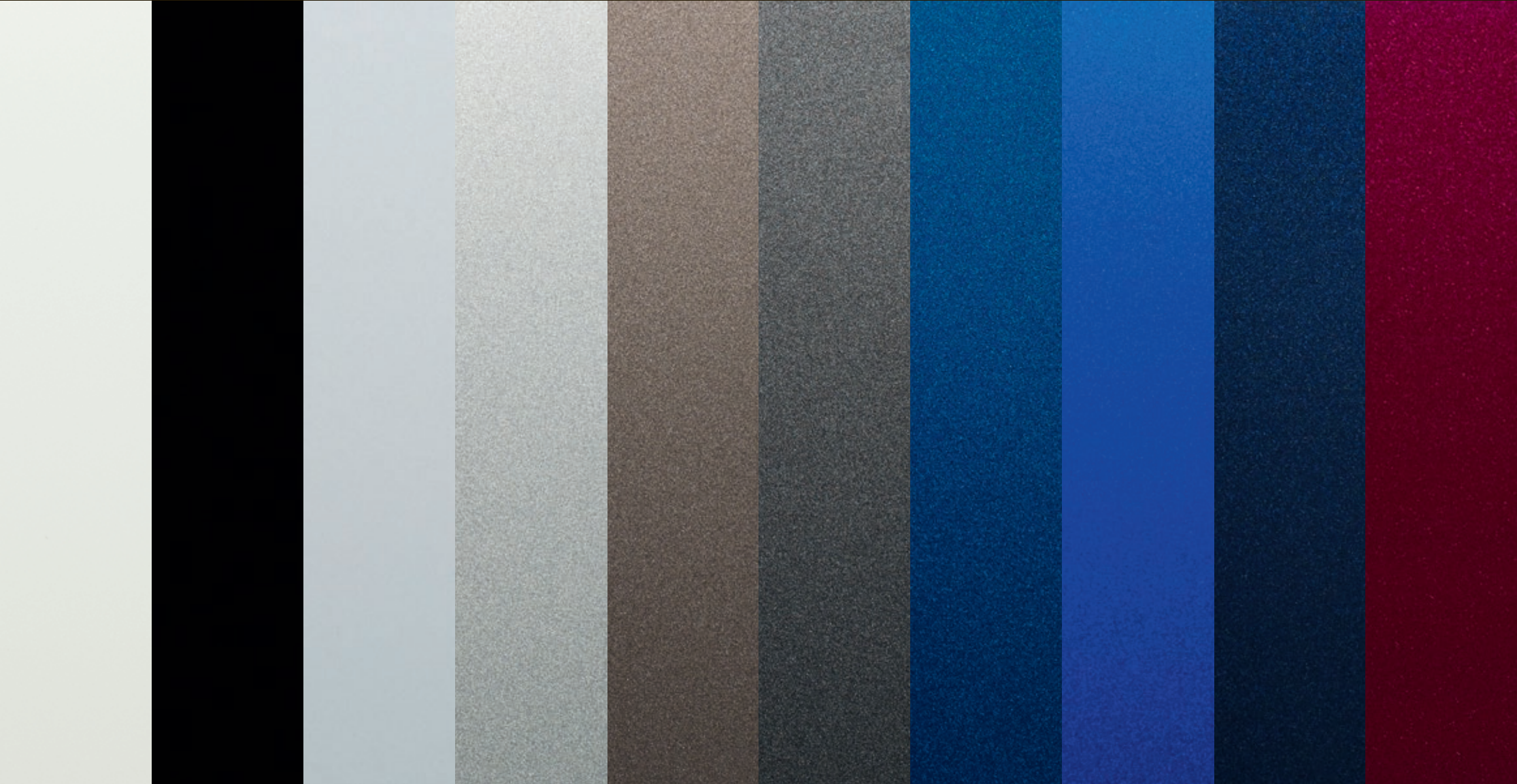

*Only available until Summer 2016.

**Available from Summer 2016.

Italian Racing Red

British Racing Green

Ultimate Black

PREMIUM PALETTE

Gallium Silver**

Ingot

Tempest Grey

Storm Grey

Celestial Black*

Black Cherry*

Cosmic Black**

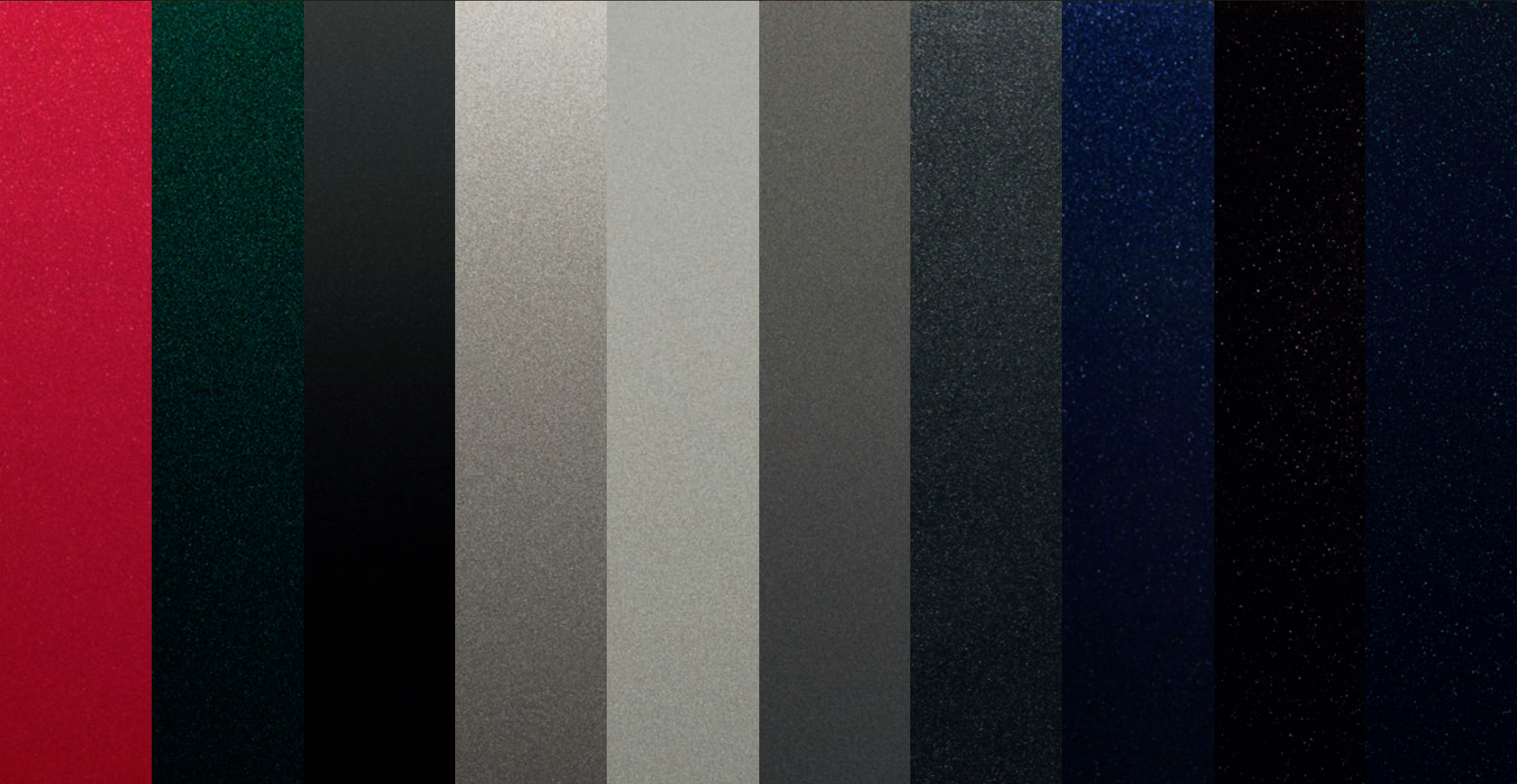

4 CHOOSE YOUR WHEELS

 Configure your vehicle at JAGUARUSA.COM



17" PROJECTOR
5 SPOKE*

Sparkle Silver

7.0J x 17"

225/50 R17

C53D



17" CRUX
7 TWIN SPOKE*

Sparkle Silver

7.0J x 17"

205/55 R17 | 225/50 R17

C53B

ALLOY WHEEL FINISH	17" PROJECTOR 5 SPOKE*	17" CRUX 7 TWIN SPOKE*
ALLOY WHEEL/SIZE	Sparkle Silver 7.0J x 17"	Sparkle Silver 7.0J x 17"
TIRE SIZE	225/50 R17	205/55 R17 225/50 R17
CODE	C53D	C53B
XE	●	—
PREMIUM	—	●
PRESTIGE	—	—
R-SPORT	—	—



18" TEMPLAR
5 TWIN SPOKE**

Silver/Diamond Turned

7.5J x 18" | 8.5J x 18"

225/45 R18 | 245/40 R18

C52L



18" ARM
6 SPOKE†

Sparkle Silver

7.5J x 18"

225/45 R18

C52P



18" MATRIX
7 TWIN SPOKE†

Sparkle Silver

7.5J x 18"

225/45 R18

C52Q



18" MATRIX
7 TWIN SPOKE†

Black

7.5J x 18"

225/45 R18

C52S

ALLOY WHEEL FINISH	18" TEMPLAR 5 TWIN SPOKE**	18" ARM 6 SPOKE†	18" MATRIX 7 TWIN SPOKE†	18" MATRIX 7 TWIN SPOKE†
ALLOY WHEEL/SIZE	Silver/Diamond Turned 7.5J x 18" 8.5J x 18"	Sparkle Silver 7.5J x 18"	Sparkle Silver 7.5J x 18"	Black 7.5J x 18"
TIRE SIZE	225/45 R18 245/40 R18	225/45 R18	225/45 R18	225/45 R18
CODE	C52L	C52P	C52Q	C52S
XE	—	—	—	—
PREMIUM	●	○	—	—
PRESTIGE	—	●	○	—
R-SPORT	—	—	●	○

● Standard ○ Option — Not Applicable

*Standard feature on 2.0 liter 4 cylinder gas/diesel derivatives as shown.

**Standard feature on 3.0 liter V6 gas derivatives as shown.

†Optional feature on 2.0 liter 4 cylinder gas/diesel derivatives as shown.

‡Optional feature on 3.0 liter V6 gas derivatives as shown.

Standard and optional features differ depending on engine selection. Please consult your local Jaguar Retailer for further details.



19" STAR
5 TWIN SPOKE***



19" RADIANCE
15 SPOKE‡



19" VENOM
5 TWIN SPOKE***‡



19" VENOM
5 TWIN SPOKE‡

ALLOY WHEEL FINISH	Sparkle Silver	Black/Diamond Turned	Silver/Diamond Turned	Black
ALLOY WHEEL/SIZE	7.5J x 19" 8.5J x 19"	7.5J x 19" 8.5J x 19"	7.5J x 19" 8.5J x 19"	7.5J x 19" 8.5J x 19"
TIRE SIZE	225/40 R19 255/35 R19	225/40 R19 255/35 R19	225/40 R19 255/35 R19	225/40 R19 255/35 R19
CODE	C52T	C52M	C52V	C52W
XE	—	—	—	—
PREMIUM	○	—	—	—
PRESTIGE	●	○	○	○
R-SPORT	—	○	●	○



20" PROPELLER‡
10 SPOKE

ALLOY WHEEL FINISH	Silver/Diamond Turned
ALLOY WHEEL/SIZE	8J x 20" 9J x 20"
TIRE SIZE	235/35 R20 265/30 R20
CODE	C52K
XE	—
PREMIUM	—
PRESTIGE	—
R-SPORT	○

5 CHOOSE YOUR INTERIOR

 Configure your vehicle at JAGUARUSA.COM

XE						
	SEAT WITH TONAL STITCH	FINISHER	UPPER FASCIA	HEADLINING MORZINE	CARPET	INTERIOR TRIM CODES
Luxtec seats	Jet with Jet	Gloss Black	Jet	Light Oyster	Jet	TR01
	Latte with Latte	Gloss Black	Jet	Light Oyster	Jet	TR02
	Light Oyster with Light Oyster	Gloss Black	Oyster	Light Oyster	Oyster	TR03

PREMIUM						
	SEAT WITH TONAL STITCH	FINISHER*	UPPER FASCIA	HEADLINING MORZINE	CARPET	INTERIOR TRIM CODES
Luxtec seats	Jet with Jet	Gloss Black	Jet	Light Oyster	Jet	TR01
	Latte with Latte	Gloss Black	Jet	Light Oyster	Jet	TR02
	Light Oyster with Light Oyster	Gloss Black	Oyster	Light Oyster	Oyster	TR03

*Optional finishers are available.

PRESTIGE						
	SEAT WITH CONTRAST STITCH	FINISHER*	FASCIA UPPER/LOWER	HEADLINING	CARPET	INTERIOR TRIM CODES
Taurus Leather seats	Jet with Sienna Tan	Brushed Aluminium	Jet with Jet	Light Oyster	Jet	TR05
	Latte with Jet	Brushed Aluminium	Jet with Latte	Light Oyster	Jet	TR06
	Light Oyster with Pistachio	Brushed Aluminium	Oyster with Light Oyster	Light Oyster	Oyster	TR07
R-SPORT						
	SEAT WITH CONTRAST STITCH	FINISHER*	FASCIA	HEADLINING	CARPET	INTERIOR TRIM CODES
Taurus Leather Sports seats	Jet/Jet with Light Oyster	Etched Aluminium	Jet with Light Oyster	Jet	Jet	TR63
	Jet/Red with Red	Etched Aluminium	Jet with Red	Jet	Jet	TR10
	Jet/Midnight Blue with Midnight Blue	Etched Aluminium	Jet with Midnight Blue	Jet	Jet	TR12
	Jet/Light Oyster with Light Oyster	Etched Aluminium	Jet with Light Oyster	Jet	Jet	TR13

5 CHOOSE YOUR INTERIOR

Configure your vehicle at [JAGUARUSA.COM](https://www.jaguarusa.com)

Interior shown: Jet Luxtec seats with Gloss Black finisher, Light Oyster headlining and Jet fascia.



XE & PREMIUM

INTERIOR COLOR COMBINATIONS

1

SEAT

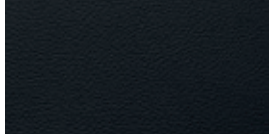

Jet

2

FINISHER



Gloss Black

3

HEADLINING



Light Oyster

4

FASCIA

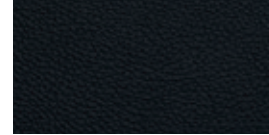

Jet

5

CARPET



Jet



Latte



Gloss Black



Light Oyster

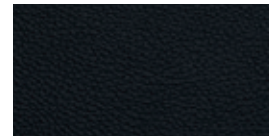

Jet



Jet

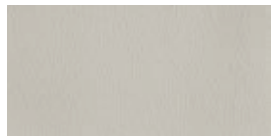

Light Oyster



Gloss Black

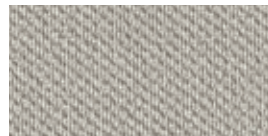

Light Oyster

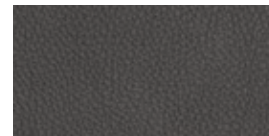

Oyster



Oyster

5 CHOOSE YOUR INTERIOR

Configure your vehicle at [JAGUARUSA.COM](https://www.jaguarusa.com)

Interior shown: Latte Leather seats with Jet contrast stitch, Brushed Aluminium finisher, Light Oyster headlining, Jet upper fascia and Latte lower fascia.



PRESTIGE

INTERIOR COLOR COMBINATIONS

1

SEAT WITH CONTRAST STITCH

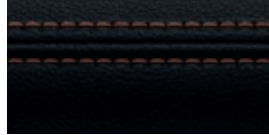

Jet with Sienna Tan

2

FINISHER*

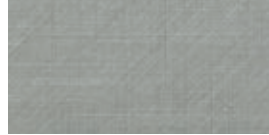

Brushed Aluminum

3

HEADLINING

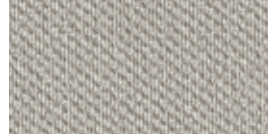

Light Oyster

4

FASCIA UPPER/LOWER



Jet with Jet

5

CARPET



Jet



Latte with Jet



Brushed Aluminum



Light Oyster

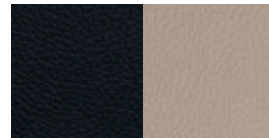

Jet with Latte



Jet

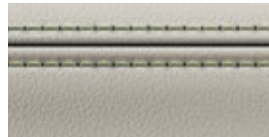

Light Oyster with Pistachio



Brushed Aluminum



Light Oyster

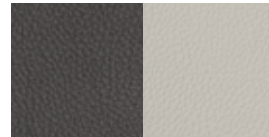

Oyster with Light Oyster



Oyster

FINISHER OPTIONS

Gloss Figured Ebony

*Console finisher is Gloss Black.

5 CHOOSE YOUR INTERIOR

⚙️ Configure your vehicle at [JAGUARUSA.COM](https://www.jaguarusa.com)

Interior shown: Jet Perforated Leather Sport seats with Light Oyster contrast stitch. Etched Aluminum finisher, Jet headlining and Jet fascia with Light Oyster contrast stitch.



R-SPORT

INTERIOR COLOR COMBINATIONS

1

SEAT WITH CONTRAST STITCH



Jet/Jet with Light Oyster

2

FINISHER*



Etched Aluminum

3

HEADLINING



Jet

4

FASCIA

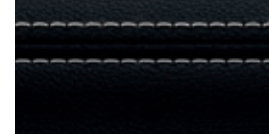

Jet with Light Oyster

5

CARPET



Jet

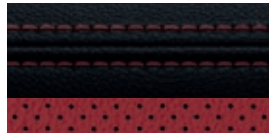

Jet/Red with Red



Etched Aluminum



Jet

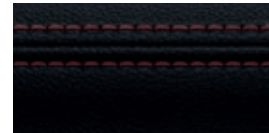

Jet with Red



Jet



Jet/Midnight Blue with Midnight Blue



Etched Aluminum

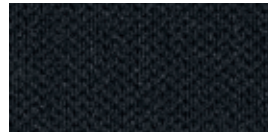

Jet



Jet with Midnight Blue



Jet

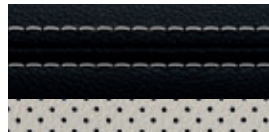

Jet/Light Oyster with Light Oyster



Etched Aluminum



Jet



Jet with Light Oyster



Jet

FINISHER OPTIONS

Satin Burl Ash or Carbon Fiber

*Console finisher is Gloss Black.

5 CHOOSE YOUR INTERIOR

 Configure your vehicle at [JAGUARUSA.COM](https://www.jaguarusa.com)

Gloss Black

Dark Satin Brushed Aluminium

Etched Aluminium

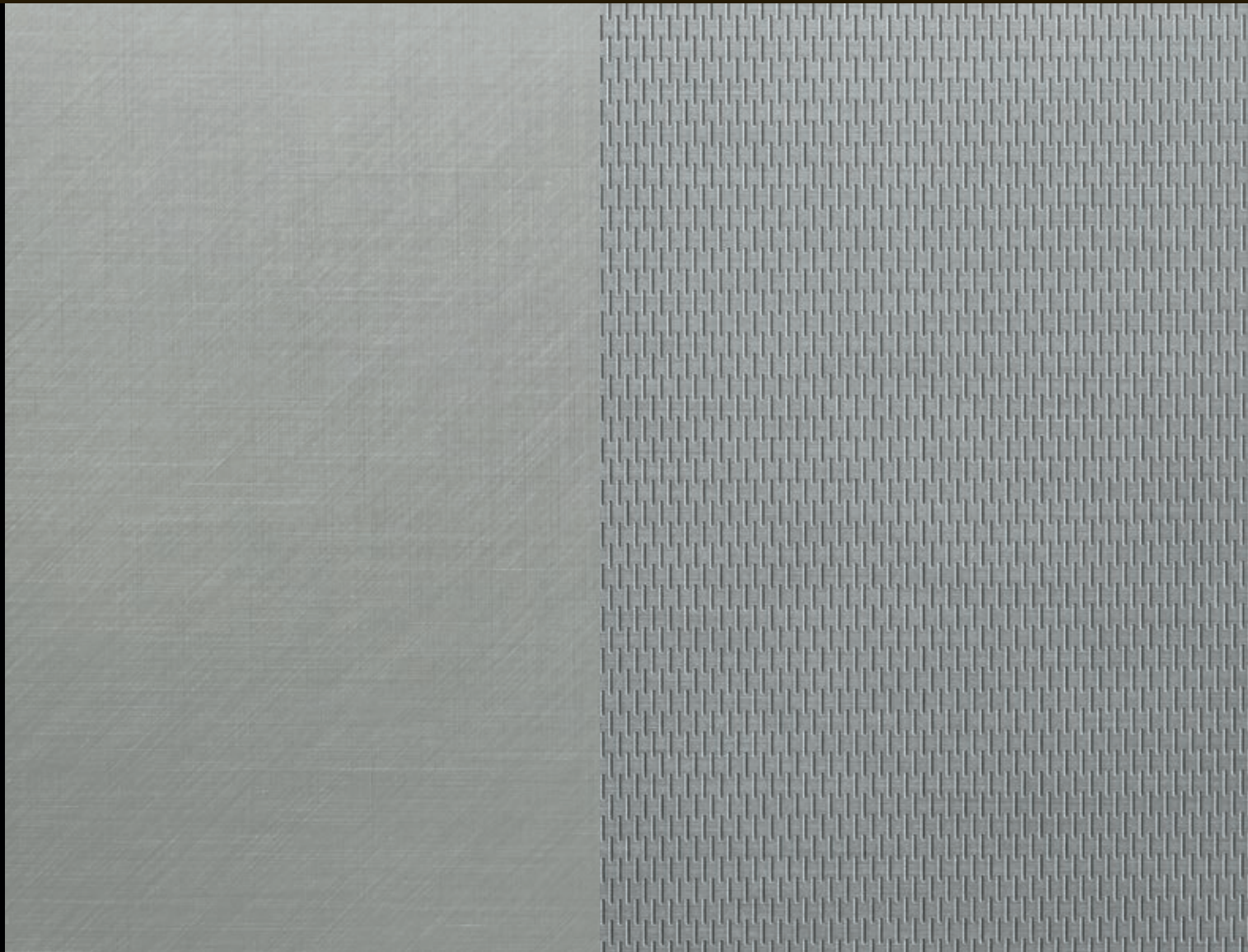

Carbon Fiber



Satin Burl Ash



Gloss Figured Ebony



6 CHOOSE YOUR JAGUAR ACCESSORIES

To find out more about the full range of Retailer fit Jaguar Accessories, please refer to your Retailer or go to JAGUARUSA.COM



Roof Mounted Cycle Carrier*
C2A1539

An easy to fit, roof mounted, lockable cycle carrier which carries one bike per holder. A maximum of three holders can be fitted.

*Requires Roof Cross Bars T4N4709.

VEHICLE SHOWN: XE R-SPORT IN ITALIAN RACING RED WITH OPTIONAL FEATURES FITTED



Personalised Illuminated Sill Treadplates
T4N7511

Elegantly styled stainless steel sill treadplate finishers for driver or passenger doors. Illuminates when either the driver or passenger doors are opened. Highlighted by soft Phosphor Blue lighting. Allows customer to specify a monochrome 'motif' in a choice of approved typefaces/scripts.



Aluminium Gearshift Paddles
T2R6547MMU

Replacement steering wheel gearshift paddles offered in a premium aluminum material providing a high quality finish to a key contact point in the vehicle. Manufactured from billet machined aluminium, the paddles are hand brushed for a premium finish and anodised to ensure they will not deteriorate with wear.



iPad® Holder
T2H7757

Jaguar branded iPad® holder mounts to front seat headrests providing a flexible solution for rear seat entertainment. Quick release design ensures iPad® can be fitted or removed quickly and easily.



Sport Pedal Covers
T2H3746 - Automatic Transmission Vehicles (not shown)

Made from stainless steel and rubber, the pedal kit fits securely over existing pedals for a contemporary, sporting appearance.



Premium Carpet Mats
T4N7146 PVJ - Jet
T4N7146 AMT - Oyster

Luxurious, tailored 2,050g/m² pile front carpet mats with embossed Jaguar logo and nubuck edge binding. The premium mats provide a well appointed finishing touch to the interior.



Premium Luggage Compartment Carpet Mat:
T4N7147PVJ

Luxurious soft luggage mat in Jet Black with the Jaguar logo. Deep premium 2,050g/m² pile with nubuck edging and Dove contrast stitch.

6 CHOOSE YOUR JAGUAR ACCESSORIES

 Configure your vehicle at JAGUARUSA.COM



Gloss Black Side Power Vent
T4N5176 - Left Side
T4N5178 - Right Side

Gloss Black side power vents provide a dynamic exterior styling enhancement.



Carbon Fiber Side Power Vent
T2H6208 - Left Side
T2H6209 - Right Side

High grade Carbon Fiber side power vents provide a performance-inspired styling upgrade.



Chrome Grille
T4N3033

Provides a Chrome finish to the grille surround and bumper beam accentuating the XE's luxury appearance.



Gloss Black Mirror Cover
C2D6066PEC - Left Side
C2D6067PEC - Right Side

Gloss Black mirror covers accentuate the dynamic design of the exterior mirrors.



Carbon Fiber Mirror Cover
C2P24176 - Left Side
C2P24177 - Right Side

High grade Carbon Fiber mirror covers provide a performance-inspired styling upgrade.



Chrome Mirror Cover
C2D5489 - Left Side
C2D5488 - Right Side

Chrome mirror covers accentuate the stylish design of the exterior mirrors.

*Requires roof cross bars T4N4709.



Roof Cross Bars
T4N4709

Jaguar branded cross bars required for fitting all roof carrying equipment. Engineered specifically for your vehicle.



Watersports Carrier*
C2Z21730

A versatile system for transporting a variety of water sports equipment including surfboard, kayak or sailboard. Tilts to facilitate loading/unloading.



Roof Sport Box*
C2C41627

Spacious 11 cubic feet capacity lockable roof box designed for sports equipment, measuring 81 x 33 x 13 inches.

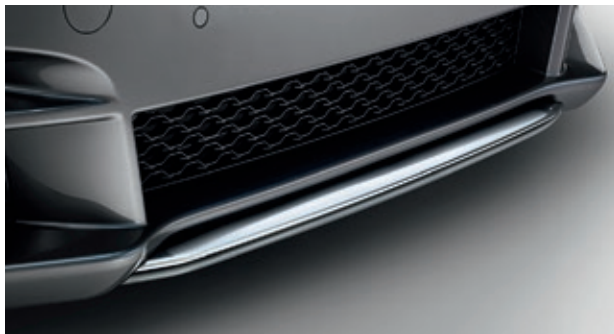

Chrome Front Splitter
T4N7599

Give the XE an even more stylish look with this bright finish front splitter blade. Body colored rear spoiler is also available. (T4N5462LML)



Rear Splash Guards
T4N7514

Jaguar branded, rear splash guards complement the lines of your vehicle and provide protection from dirt and stone chippings.



All-Weather Car Cover
T4N7502

All-weather tailored cover for the XE with the Jaguar logo. Protect your XE from the elements, including showers, frost and dust. Quick and easy to fit.

TECHNICAL SPECIFICATIONS

 Configure your vehicle at JAGUARUSA.COM

ENGINES		2.0 LITER 180 4-CYLINDER TURBOCHARGED DIESEL	2.0 LITER 240 4-CYLINDER TURBOCHARGED GAS	3.0 LITER V6 340 SUPERCHARGED GAS
Drive		RWD	RWD	RWD
Capacity	cc	1,999	1,999	2,995
Maximum power	hp	180	240	340
@rev/min	rpm	4,000	5,500	6,500
Maximum torque	lb.ft.	318	251	332
@rev/min	rpm	1,750-2,500	1,750-4,000	4,500
Transmission		8-speed automatic	8-speed automatic	8-speed automatic
PERFORMANCE*				
0-60 mph	seconds	7.5	6.5	5.1
Top speed	mph	120	120	120
FUEL CONSUMPTION**				
City	mpg	TBD	TBD	TBD
Highway	mpg	TBD	TBD	TBD
Combined	mpg	TBD	TBD	TBD
Tank capacity (usable)	US gallons	14.8	16.6	16.6
DIMENSIONS				
Overall length	in	183.9	183.9	183.9
Overall width (inc. mirrors)	in	81.7	81.7	81.7
Overall width (exc. mirrors)	in	77.4	77.4	77.4
Overall height	in	55.7	55.7	55.7
Wheelbase	in	111.6	111.6	111.6
Front track	in	62.8-63.2	62.8-63.2	62.8-63.2
Rear track	in	62.4-63.3	62.4-63.3	62.4-63.3
Ground clearance	in	4.3	4.3	4.3
Turning circle diameter (curb to curb)	ft	38.4	38.4	38.4
Trunk volume	cu-ft	15.9	15.9	15.9
WEIGHT†				
Weight from	lb	3,320	3,350	3,605
Gross vehicle weight	lb	4,707	4,674	4,916
ENGINE AVAILABILITY				
XE		●	●	—
PREMIUM		●	●	●
PRESTIGE		●	●	●
R-SPORT		●	—	●

● Available — Not Available

*Always follow local speed limits.

**EPA estimates not available at time of publication. See your local Jaguar Retailer for updated EPA estimates.

†Weights reflect vehicles to standard specifications. Optional extras increase weight.

ENGINES		2.0 LITER 180 4-CYLINDER TURBOCHARGED DIESEL	3.0 LITER V6 340 SUPERCHARGED GAS
Drive		AWD	AWD
Capacity	cc	1,999	2,995
Maximum power	hp	180	340
@rev/min	rpm	4,000	6,500
Maximum torque	lb.ft.	318	332
@rev/min	rpm	1,750-2,500	4,500
Transmission		8-speed automatic	8-speed automatic
PERFORMANCE*			
0-60 mph	seconds	7.5	5.1
Top speed	mph	120	120
FUEL CONSUMPTION**			
City	mpg	TBD	TBD
Highway	mpg	TBD	TBD
Combined	mpg	TBD	TBD
Tank capacity (usable)	US gallons	14.8	16.6
DIMENSIONS			
Overall length	in	183.9	183.9
Overall width (inc. mirrors)	in	81.7	81.7
Overall width (exc. mirrors)	in	77.4	77.4
Overall height	in	55.7	55.7
Wheelbase	in	111.6	111.6
Front track	in	62.8-63.2	62.8-63.2
Rear track	in	62.4-63.3	62.4-63.3
Ground clearance	in	4.3	4.3
Turning circle diameter (curb to curb)	ft	38.4	38.4
Trunk volume	cu-ft	15.9	15.9
WEIGHT†			
Weight from	lb	3,560	3,795
Gross vehicle weight	lb	4,916	5,026
ENGINE AVAILABILITY			
XE		●	—
PREMIUM		●	●
PRESTIGE		●	●
R-SPORT		●	●

DIMENSIONS

Overall Width (inc mirrors) 81.7 inches

Overall Width (exc mirrors) 77.4 inches

Trunk Volume 15.9 cu-ft



Turning Circle
Curb to Curb 38.4 ft

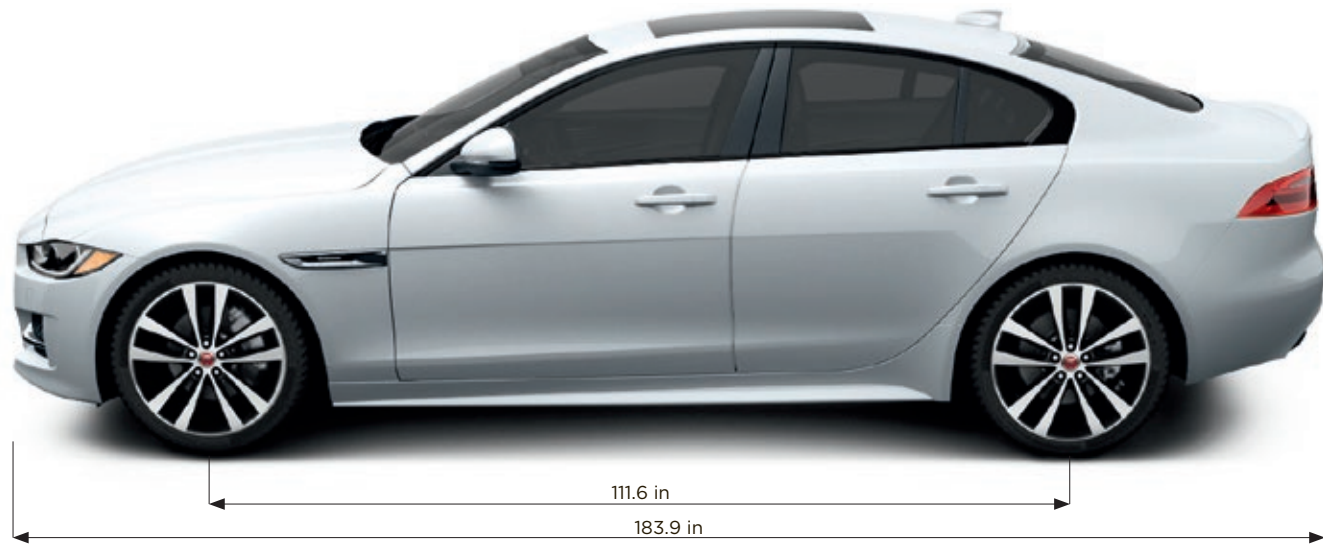
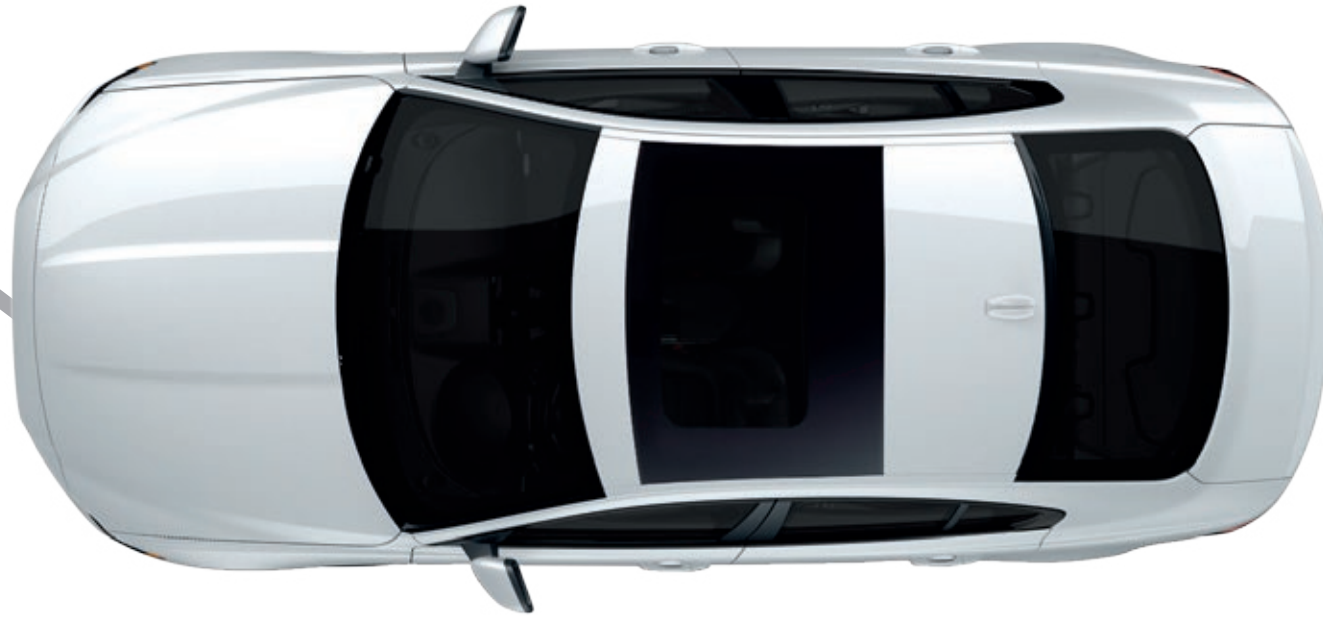

Dimensions were measured with vehicle at unladen weight
(measured by VDA standard test method using 200 x 100 x 50mm blocks).

JAGUAR EXPERIENCE

There's no better way to get to know Jaguar than by taking a drive. The Jaguar Experience offers a range of unique opportunities to really find out what it feels like to get the most out of a Jaguar. Our track experiences allow you to push yourself and cars from the incredible Jaguar range to the limit. Jaguar Experience also offers the opportunity to see a Jaguar brought to life during a tour of one of our UK manufacturing facilities.

Find out more by visiting JAGUARUSA.COM



BEHIND THE SCENES

Our factory tours give you the unique opportunity to experience the whole process of how our cars are brought to life - from the moulding of sheet metal to those intricate final touches. At our state-of-the-art production facilities, you'll get to see how skilled technicians and sophisticated machines work seamlessly together to perfect some of Jaguar's most breathtaking cars - from the powerful F-TYPE to the groundbreaking F-PACE performance SUV.

Find out more at JAGUARUSA.COM



DRIVING EXPERIENCES

The opportunity to drive the latest Jaguar cars at their limits, or relive iconic Jaguar history, is rare. Jaguar Driving Experiences offer unique driving adventures you will never forget. Imagine yourself behind the wheel of our highest performing Jaguar models, on a private track, with a Jaguar Experience Instructor at your side. This is the Jaguar Performance Driving Academy.

Find out more at JAGUARUSA.COM



ICONIC EXPERIENCES

Take your driving to the next level with our international adventures facing extreme on-road, and off-road, conditions. Our Iconic Experiences offer journeys and challenges that will test and develop your performance driving skills. Every year, Jaguar customers and enthusiasts join us for our luxury Ice Driving Experience. The exclusive ski resort in Gstaad, Switzerland, is the perfect location to enjoy the thrill of performance driving on ice. Our Ice Driving Experience is a two-day getaway held each winter. You can get a flavor of the event below. Then, if you'd like to be part of it in the next experience, we can keep you posted.

Find out more at JAGUARUSA.COM

THE WORLD OF JAGUAR

Choose an XE and you're joining the exciting World of Jaguar. It makes owning and driving carefree and easy, as well as providing a range of exclusive services and lifestyle products.

JAGUAR ELITECARE

5 YEARS 60,000 MILES

- ④ New Vehicle Limited Warranty
- ⑤ Complimentary Scheduled Maintenance
- ⑥ 24-Hour Roadside Assistance
- ⑦ Jaguar InControl® Remote & Protect™

BEST IN CLASS COVERAGE*

JAGUAR ELITECARE

Enjoy your Jaguar with complete peace of mind.

The XE is now backed by the Best-In-Class Jaguar EliteCare*, our exceptional 5 year / 60,000 mile coverage program including New Vehicle Limited Warranty, Complimentary Scheduled Maintenance, Roadside Assistance and InControl Remote & Protect™.



NEW VEHICLE LIMITED WARRANTY

The New Vehicle Limited Warranty (the "Warranty") lets you enjoy your driving with peace of mind and runs for a best in class 5 years or 60,000 miles, whichever occurs first. The Warranty is fully transferable to subsequent owners and remains in effect throughout the Warranty coverage period.

*Class is cars sold by luxury automobile brands and claim is based on total package of warranty, maintenance and other coverage programs. For complete details regarding Jaguar EliteCare coverage, visit JAGUARUSA.COM, call 1.800.4.JAGUAR or visit your local Jaguar Retailer.

**Servicing your vehicle at the specified interval is critical to maintaining its long-term durability. Failure to perform scheduled maintenance within 1000 miles of the recommended interval may void the Warranty under certain circumstances.



COMPLIMENTARY SCHEDULED MAINTENANCE**

Relax in the knowledge that long-term performance is assured with the Complimentary Scheduled Maintenance Coverage. It covers factory recommended scheduled servicing as detailed in the "Passport to Service" for 5 years or 60,000 miles, whichever occurs first**. A Service Interval Indicator will appear every 16,000 miles or every 12 months, to remind you to take advantage of your complimentary maintenance.

GENUINE PARTS

Jaguar Genuine Parts are designed, tested and manufactured to our uncompromising standards for quality, fit and durability. Each part is engineered specifically for the XE to contribute to optimum performance and to help maximize its lifespan.



ROADSIDE ASSISTANCE

Jaguar Roadside Assistance provides assistance in motoring emergencies, from immobilization due to breakdown or accident to minor problems such as punctures. You can rely on our roadside assistance, whatever the situation, anywhere in North America during the vehicles warranty period.



JAGUAR MAGAZINE

Jaguar Magazine is the official magazine of Jaguar Cars. It features the Jaguar F-PACE, XE, XJ, XF and F-TYPE, and the worlds of luxury, style, design and travel.

JAGUAR COLLECTION

The latest range from the Jaguar Collection has been crafted with the same design execution and attention to detail that goes into all of our cars. This is evident in our clothing range, premium leather items and luxury travel goods. To celebrate Jaguar's heritage we also have a collection that honours past achievements and features race-inspired gift items and apparel. To find out more, visit your local Jaguar Retailer.

GLOSSARY

A

AUDIO EQUALIZATION

Audio Equalisation lets you fine tune the sound of your car's audio system by giving you tone adjustment not covered by standard treble, mid-range, and bass controls.

C

Cd

The Cd value is the drag coefficient of the car. It gives an indication of the vehicle's aerodynamic qualities. The lower the value, the more aerodynamically efficient the vehicle's design.

D

DAMPERS/DAMPING

Dampers absorb forces acting on the suspension for greater ride comfort and control. Dampers are also known as shock absorbers.

DRAG COEFFICIENT

The drag coefficient measures how aerodynamic a car is. See definition of Cd.

DSP AMPLIFIER

Meridian's Digital Signal Processing (DSP) technology analyses a range of variables that may impact audio quality, then processes them using sophisticated algorithms and adapts the system's output accordingly. This enables a level of powerful, authentic performance impossible with a conventional sound system.

E

ECO MODE

Eco Mode encourages fuel efficient driving by reducing throttle sensitivity, selecting more economical engine mapping and, on manual vehicles, advising of gear shifts. It also reduces fuel consumption by reducing the energy demands placed on the engine by climate control and audio systems.

J

JAGUARDRIVE CONTROL

Interacts with the Dynamic Stability Control system, engine and transmission management systems to alter the characteristics of the engine mapping, gear shifts and brakes. It offers different modes designed to optimise the vehicle's response to particular driving conditions and styles.

"J" BLADE DAYTIME RUNNING LAMPS

"J" blade Daytime Running Lamps are separate LED running Lamps, in a distinctive 'J' shape, built into the headlamps. They emphasize the striking on-road style of Jaguar vehicles.

JAGUARDRIVE SELECTOR

The JaguarDrive Selector rises from the centre console on start up. It is a rotary shifter used with automatic transmissions that allows you to quickly shift between drive modes.

M

MHL CONNECTION

A Mobile High-Definition Link (MHL) enables connection between a personal device and the InControl infotainment system. It is designed for seamless transfer of audio-visual data.

T

10.2 INCH MULTI-TOUCHSCREEN WITH MULTI-TOUCH GESTURES

The Multi-touch functionality of InControl Touch Pro's 10.2 inch Display allows the screen to recognize multiple points of contact. This provides direct control of the system's features in a more natural, intuitive way, enabling gestures such as pinch and zoom.

TURBOCHARGED DIESEL

Diesel engine with a turbocharger. A turbocharger is a forced induction device powered by exhaust gases. Turbocharging produces higher power outputs, lower emissions levels, and improved efficiency and refinement compared to similar capacity naturally aspirated engines.

X

XENON HEADLAMPS

Bi-function Xenon headlamps offer improved illumination and feature LED 'J' blade Daytime Running Lamps for a striking on road style.

DISCLAIMERS

¹Do not use Jaguar InControl® features under conditions that will affect your safety or the safety of others. Driving while distracted can result in loss of vehicle control.

²Driving while distracted can result in loss of vehicle control. Do not operate, adjust or view the navigation or multimedia systems under conditions that will affect your safety or the safety of others. Only use mobile phones, and other devices, even with voice commands, when it is safe to do so.

³The Wi-Fi hotspot is intended for passenger use only. InControl® features may require an additional subscription with separate terms and conditions.

⁴A 3-month trial subscription to the SiriusXM® All Access package is included with the vehicle, which gives you access to 175+ channels of premium programming. Plus you can stream SiriusXM® on your computer, smartphone or tablet - it's included in your trial. If you decide to continue service after your trial, the subscription plan you choose will automatically renew thereafter and you will be charged according to your chosen payment method at then-current rates. Fees and taxes apply. To cancel you must call SiriusXM® at 1-866-635-2349. See the SiriusXM® Customer Agreement for complete terms at siriusxm.com. All fees and programming are subject to change. SiriusXM® Satellite Radio is not available in Alaska, Hawaii, or Puerto Rico.

⁵These features are not a substitute for driving safely with due care and attention and will not function under all circumstances, speeds, weather and road conditions, etc. Driver should not assume that these features will correct errors of judgment in driving. Please consult the owner's manual or your local Jaguar Retailer for more details.

⁶Please remember that the safety belts in a vehicle constitute the primary protection system for driver and passengers in collisions. Airbags are not designed to deploy in all collisions. The airbag Supplemental Restraint System (SRS) is a supplement to the safety belts and is designed to work as a system with the safety belts. Although airbags provide additional protection, airbags without safety belts do not provide optimal protection in a crash. Always wear your safety belts. Children younger than 13 years old should always be properly restrained in a back seat, away from airbags. Never place an infant seat in the front seat.

⁷All figures are Manufacturer's fuel economy estimates. Actual mileage may vary. EPA estimates not available at time of publication. See your local authorized Jaguar Retailer for updated EPA estimates.

⁸Always follow local speed limits.



IMPORTANT NOTICE

Jaguar Land Rover Limited is constantly seeking ways to improve the specification, design and production of its vehicles and alterations take place continually. While every effort is made to produce up-to-date literature, this brochure should not be regarded as an infallible guide to current specifications, nor does it constitute an offer for the sale of any particular vehicle. Distributors and Retailers are not agents of Jaguar Land Rover Limited by any express or implied undertaking or representation. Comparisons are based on manufacturer's own data and testing prior to publication.

COLORS

Print and online colours are representative only.

ENVIRONMENTAL INNOVATION AT JAGUAR

F-PACE, XF, XE, XJ and F-TYPE innovative use of lightweight aluminium, which incorporates up to 50% closed-loop recycled material from the manufacturing process of the body structures, provides considerable performance benefits. This includes improved fuel consumption and less CO₂ emissions during the use phase of the Life Cycle due to lighter structures. Our on-going target is to ensure scrap aluminium reclaimed from our stamping process is to be segregated and recycled through a closed loop system and incorporated back into the same grade quality aluminium sheet, therefore reducing CO₂ emissions, versus the use of virgin aluminium sheets, during the production phase of the Life Cycle.

Jaguar is committed to reducing dependency on fossil fuels, using fewer natural resources and creating less waste as part of our approach to responsible and sustainable business development, called Environmental Innovation.

The company plan includes ongoing reduction in CO₂ emissions & the use of natural resources and at the end of 2014 we have achieved a 28% reduction in operating CO₂ emissions, 25% in the Company's European fleet average tailpipe emissions, 75% in waste to landfill, logistics efficiencies (18%) and water consumption (10%), all based on per vehicle built since 2007. In addition the manufacturing assembly CO₂ emissions of each Jaguar built in the UK since 2009, is 100% offset as part of our 2020 strategy for carbon neutral manufacturing assembly and since 2013 carbon-for-development projects form a key part of the company's Global Corporate Social Responsibility (CSR) programme.

For each tonne of CO₂ emitted in the assembly process, the company invests in emissions reductions projects that reduce an equivalent tonne of CO₂ elsewhere and provide social and humanitarian benefits at the same time. Since 2013 the programme has offset 800,000 tonnes of CO₂ and improved the lives of over 2 million people from our award winning Lifestraw carbon-for-water emissions reduction programme.

Taking into account the company's global sales growth and increased investment in more efficient operating facilities, we are proud to have delivered and in some cases exceeded our Environmental Innovation targets as planned between 2012-2015 But it doesn't stop there. Our manufacturing facilities have been certified to ISO14001 since 1998 and in 2013 the Company was recognised as the UK's Responsible Business of the Year by leading CR index, Business in the Community. In 2014 we built on this success through the Queens award for Enterprise in Sustainable Development for 2014.

Looking forward, we have developed our 2020 vision for sustainable business growth that focuses on continued improvements in operating & tailpipe CO₂ emissions, carbon neutral manufacturing and zero waste. The company will also improve the lives of 12 million people by 2020 as part of the global Corporate Social Responsibility programme

Meridian is the registered trademark of Meridian Audio Ltd.

AdBlue. is the registered trademark of the Verband der Automobilindustrie e. V. (VDA).

The Bluetooth. word mark and logos are owned by the Bluetooth SIG, Inc. and any use of such marks by Jaguar Land Rover Limited is under license.

iPod, iPod touch and iPad are trademarks of Apple Inc, registered in the US and other countries.

SOME OF THE VEHICLES FEATURED IN THE PHOTOGRAPHS THROUGHOUT THIS BROCHURE ARE EUROPEAN MODELS AND MAY NOT BE AVAILABLE IN NORTH AMERICA. PLEASE CONSULT YOUR LOCAL JAGUAR RETAILER FOR SPECIFIC MODEL AVAILABILITY.

**VEHICLE SHOWN FRONT COVER: XE R-SPORT IN ITALIAN RACING RED WITH OPTIONAL FEATURES FITTED
VEHICLE SHOWN BACK COVER: XE R-SPORT IN GLACIER WHITE WITH OPTIONAL FEATURES FITTED**

