

THE  
NEW FORD BEAUTIFUL  
FOR 1942

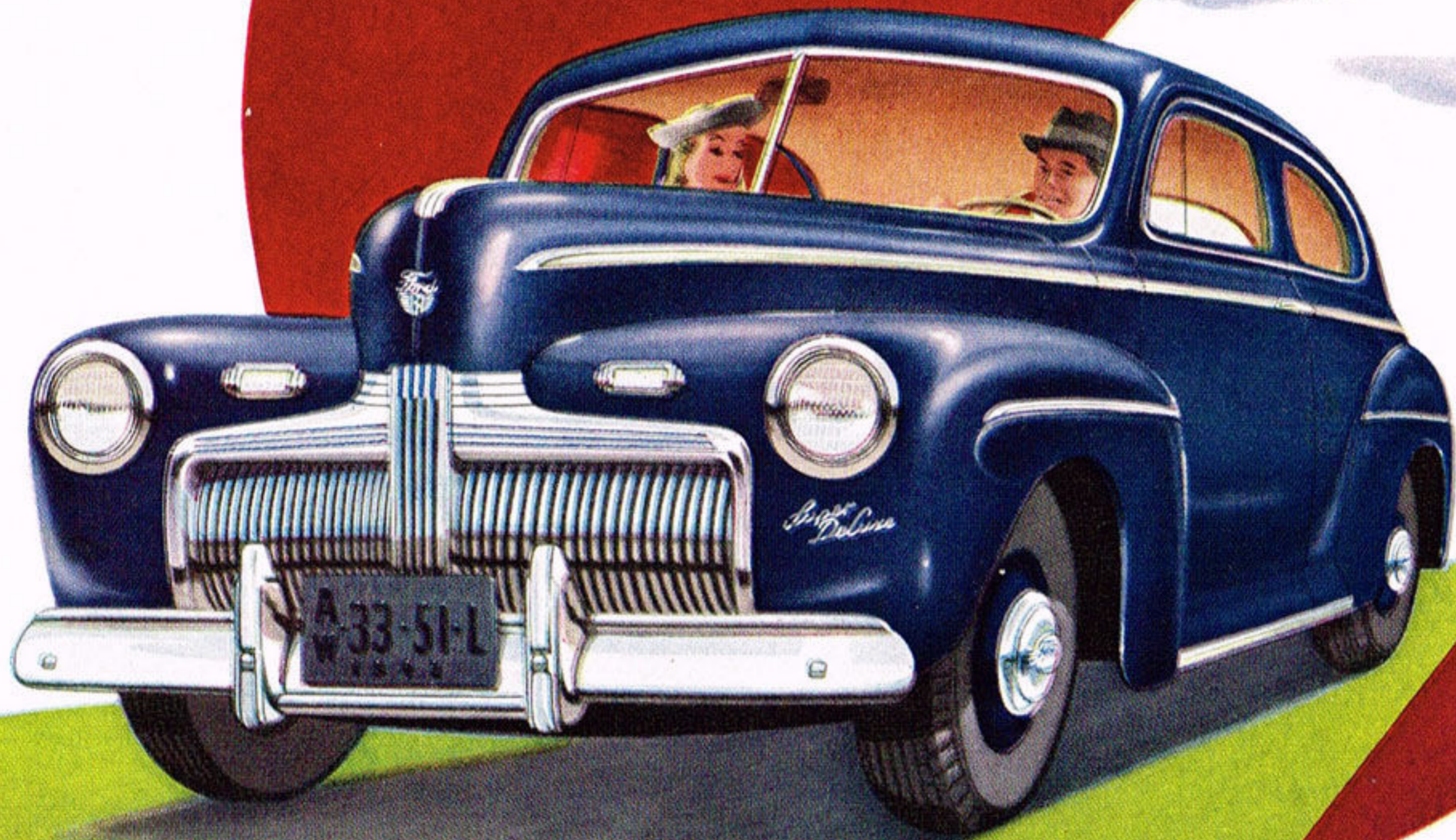

## The Ford Idea and Your New Car

IT IS WITH especial pride that we show you these new Ford cars for 1942. They are the best—and *much* the best—we have ever made. In them the fundamental Ford idea of *extra* basic value at their price stands out as never before.

Moreover, defense requirements

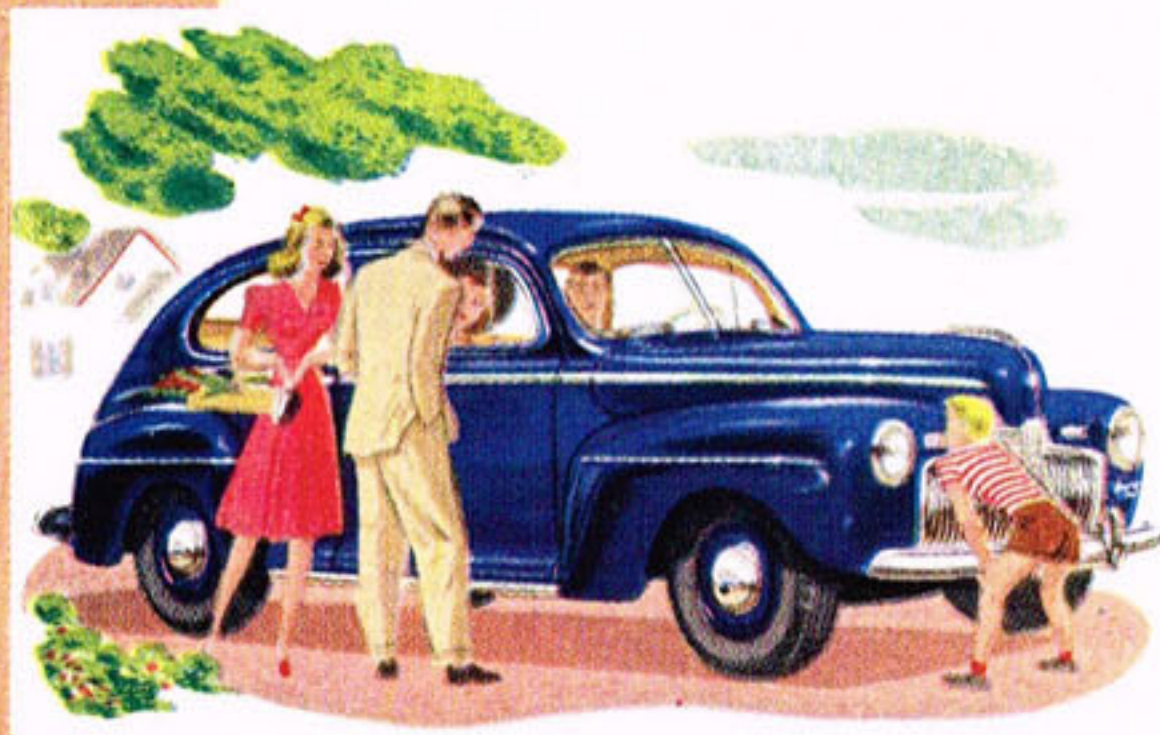

have been met without a single reduction in the quality of the car or the slightest sacrifice in its mechanical design. Some new materials have replaced old ones, in most cases at greater cost to us, but in every case the new is equal to or better than the old.

*You may buy a Ford today with our word for it that its quality, useful-*

*ness, and in-built long life were never higher, nor as high, as they are now.*

Under the hood this year you have your choice of a "6" or an "8," both 90 horsepower, both rugged, reliable, gas-and-oil-saving engines, outstanding for performance and for thrift.

In its massive front end, its pleasing appointments and its beauty of design throughout, this car exceeds by far anything we have done before. Outside and in, this is a modern car, a beautiful car by any standard you may set.

In comfort, two features are notable in the Ford of today. One is its size . . . its sweeping width of seats and doors and windows. The other is the soft, level, "new Ford ride," so great a success last year, and now further improved in softness, quietness, steadiness and ease.

In these pages is the story of an unusual car, well suited to these unusual times. A car rich in transportation and sure in staying power. A good car to own today and through the years to come.

NOW  
YOU  
CAN →  
CHOOSE



### AMERICA'S LOWEST-PRICED "V-8"

PROVED by millions of owners . . . improved this year to give still faster response . . . so thrifty on oil that countless owners report none added between regular changes . . . a several times leader in its class for gasoline mileage in AAA-supervised economy runs.

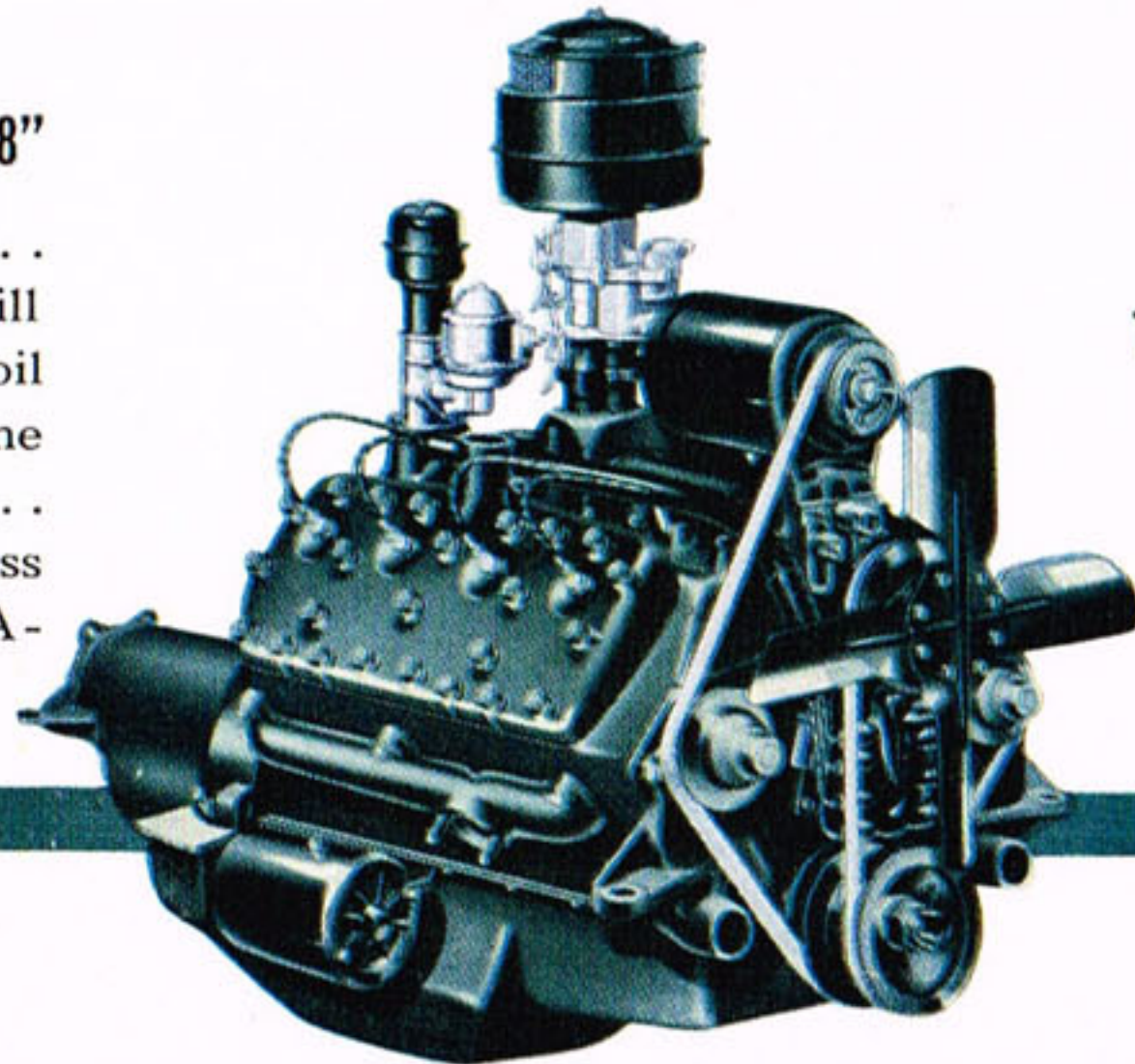

The Great  
Ford V-8

a "Six" or an "Eight"

### AMERICA'S MOST MODERN "6"

NOT JUST another Six. We believe it is basically finer in design, construction and performance than any six cylinder engine in its field. It's a big rugged engine of L-head design—smooth, quiet, and tremendously responsive.

*Running Mate to the Ford V-8*

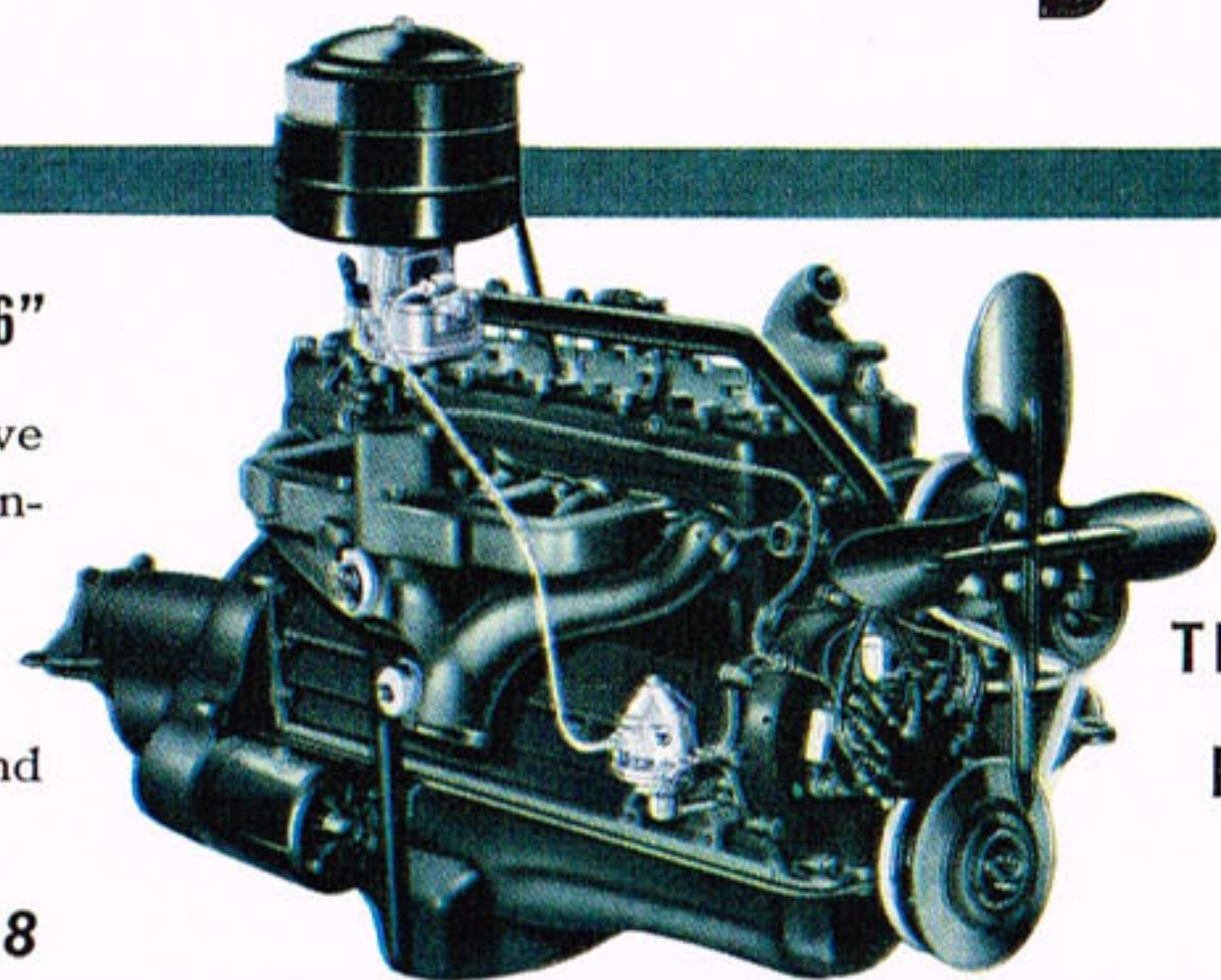

The New  
Ford 6

*Super DeLuxe* FORDOR SEDAN

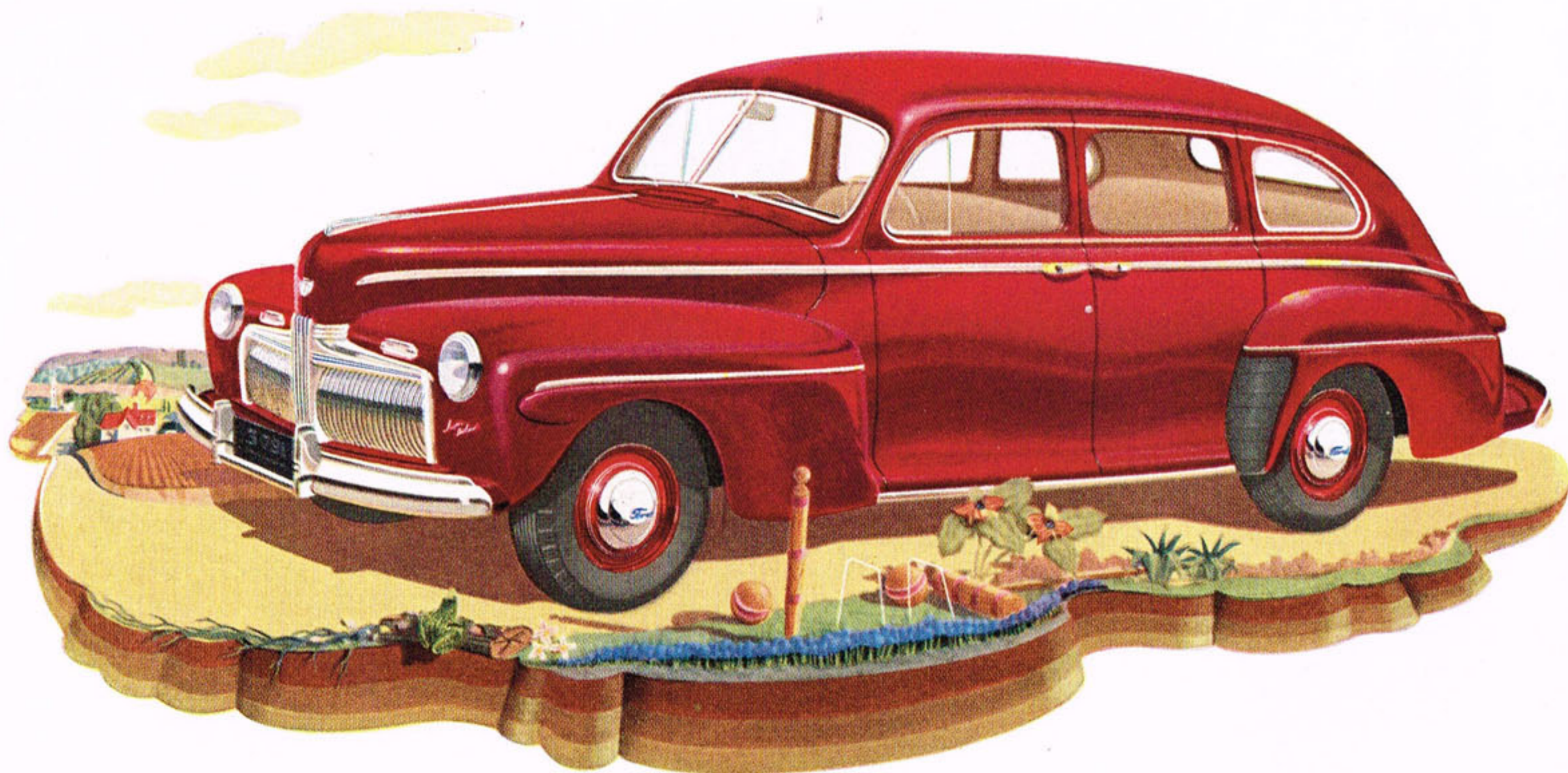

A GOOD PLACE to sit and ask yourself, "Why pay more for any car?" is at the wheel of this big, beautiful, easy-riding Fordor Sedan. Six people can ride with plenty of room, even when they're *big* people! A long, wide, low car, with lines shrewdly calculated to make the most of its bigness by gracefulness in motion. 6 or 8 cylinders, you have your choice.

*This catalog, on the press prior to August 23, 1941, shows cars illustrated with white sidewall tires for which there is an extra charge. The manufacture of these tires being discontinued after that date to conserve materials for National Defense makes them unavailable after stocks are exhausted.*

*Super DeLuxe* TUDOR SEDAN

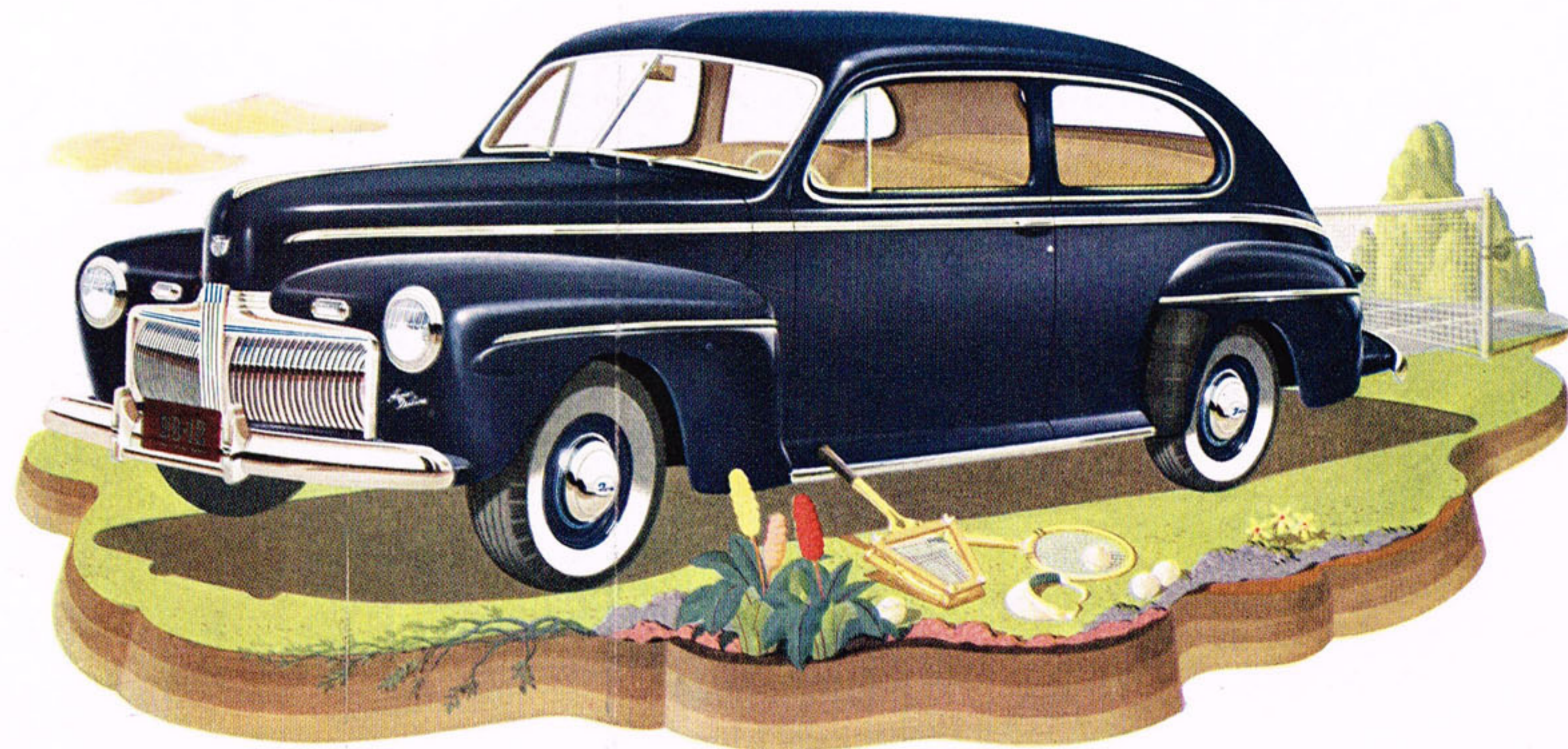

WIDE DOORS... divided seat backs that pivot inward as they fold down, giving more clearance for passengers stepping into the rear seat... seats that accommodate six comfortably... door handles controlled from the front compartment... all help explain why the Tudor is such a popular body type, especially where there are children. White sidewall tires extra.

*Super De Luxe* COUPE

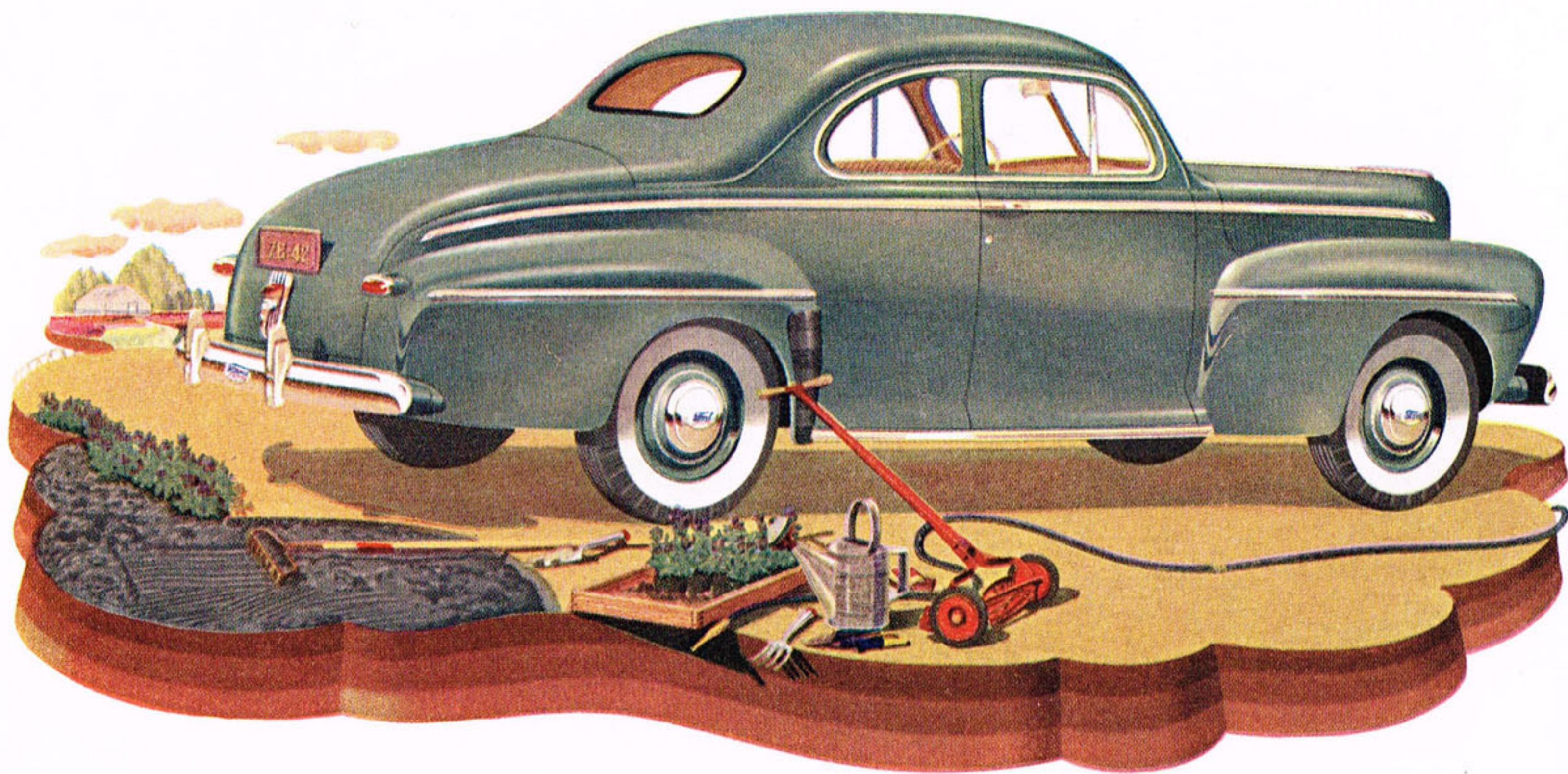

TO MANY motorists, the Coupe represents motor car design in its most pleasing development. It is as suitable for business or professional use as it is for shopping. There is a large luggage compartment which is reached through the rear deck. Inside the car, the one piece seat back lifts up to reveal additional space for luggage. The white sidewall tires are extra.

*Super De Luxe* CONVERTIBLE CLUB COUPE

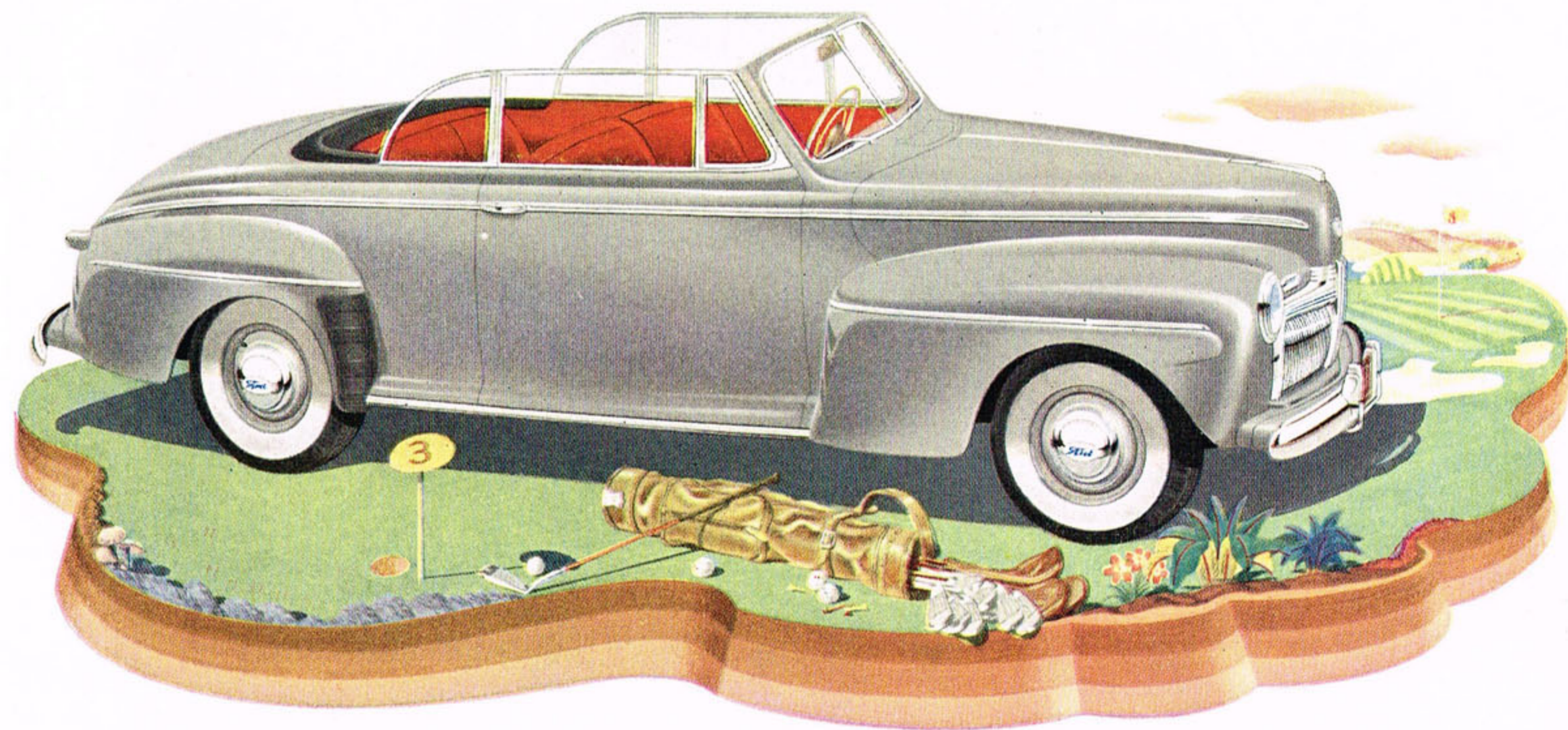

YOU WOULD have to look far and pay high for a sportier car than this new Ford Convertible . . . or for a more sensible sport car. Wide seats carry five comfortably. Side windows for rear seat, new this year, give passengers and driver alike better vision. The snug-fitting top is raised or lowered automatically at the touch of a button. White sidewall tires extra.

*Super De Luxe* SEDAN-COUPE

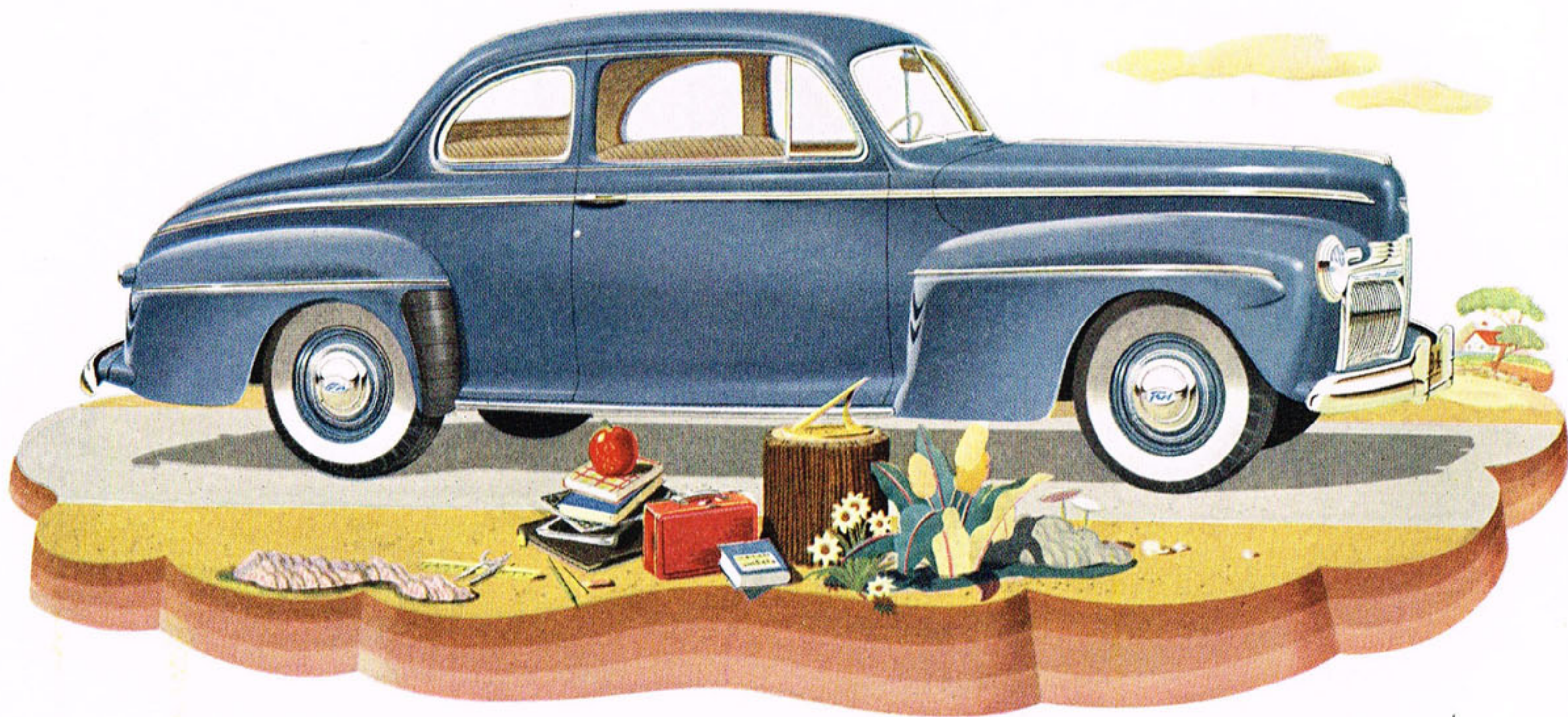

IF YOU LIKE the compactness of a Coupe, with the six-passenger seating room of a Sedan, this is the car for you. Its long, low lines suggest the art of the custom builder. The rear seat is easily reached from either door. Luggage space is generous beneath the sweeping rear deck. The ideal car for small families with big ideas. White sidewall tires are extra.

*Super De Luxe* STATION WAGON

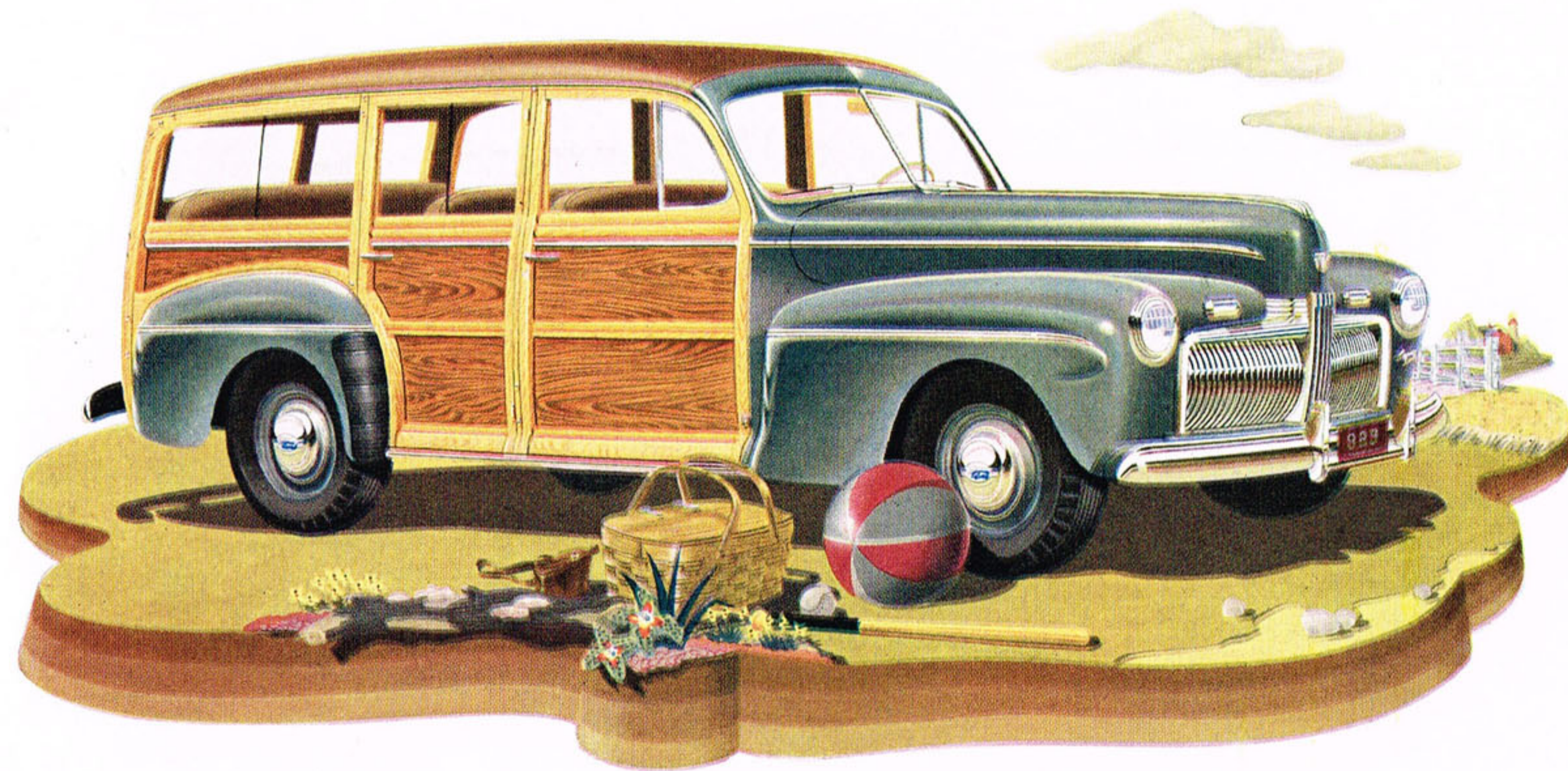

THE FORD Station Wagon holds a special place of its own in the American motoring scene. Wide seats carry eight, including the driver. The quick removal of rear and center seats gives a light utility hauling unit of great capacity. Safety Glass is used all around. Tail gate, when lowered, forms a sturdy luggage platform. Doors and tail gate can be locked.

## DeLuxe COUPE



THE De Luxe Coupe, like each De Luxe car, duplicates its companion Super De Luxe car in seating arrangement and room—differs mainly in appointments. Also available are Tudor Sedan, Fordor Sedan, and a new Sedan-Coupe. Even lower in price is the Ford "Special" line, available with six-cylinder engine only in Fordor, Tudor and Coupe. White sidewall tires extra.

## IMPORTANT IMPROVEMENTS That Make Driving Easier



THE MORE responsive your engine, the more fun you get out of driving. So it's important news that the Ford V-8 is faster and more powerful than ever this year . . . that the new Ford 6 is outstanding for responsiveness.



**BETTER STEERING!** Both the "feel" and the mechanical action of Ford steering have been improved. A heavier steering jacket tube, plus a new ball bearing at the column top, makes for smoother steering, reduces vibration and road shock.

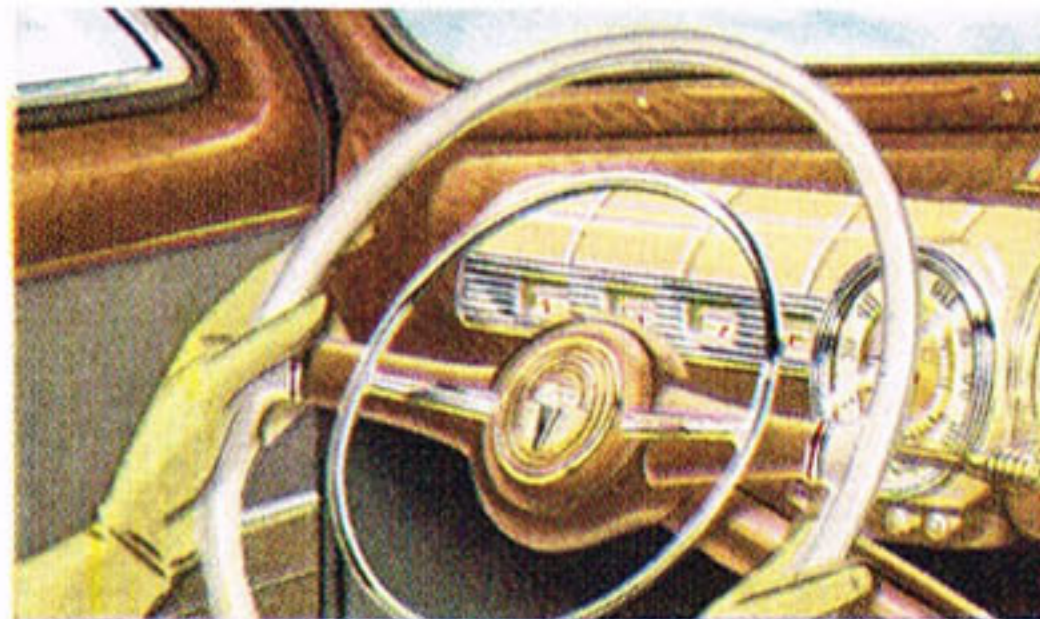

**EASIER SHIFTING!** The Ford steering post shift has been a success from the start, with its simple mechanical construction of the fine-car type and silent blocker type transmission. This year the shifting leverage has been increased; you slip from one speed to another with less effort than ever!

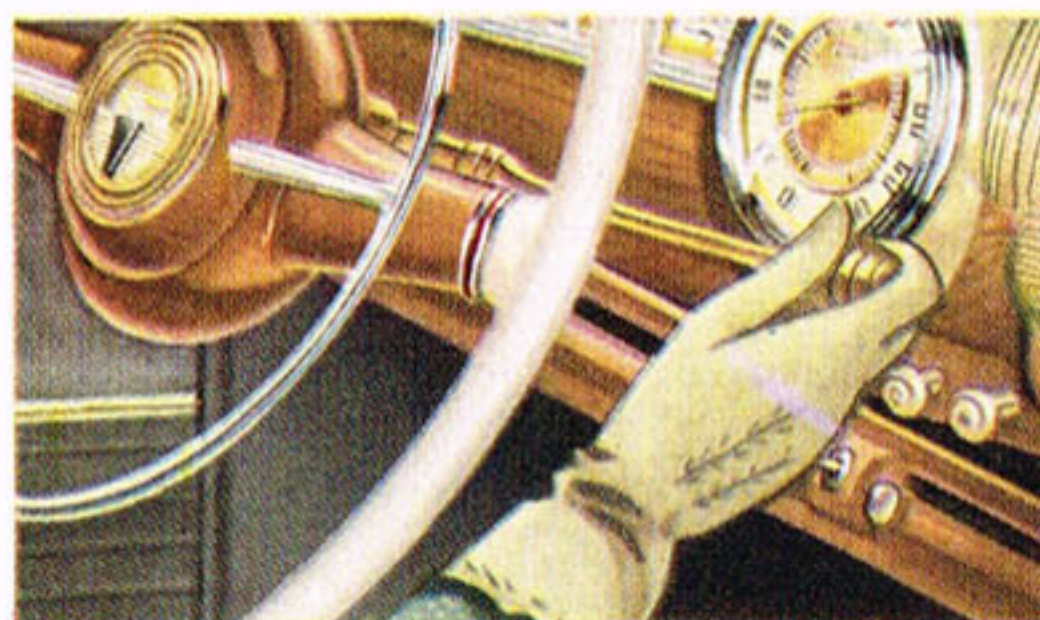

**EASIER BRAKING!** The oversize Ford hydraulic brakes were designed to produce fast, straight stops with low foot pressure on the pedal. This year they work still easier! A better distribution of braking pressure between front and rear wheels gives assurance of straight line stops.



**SURER CONTROL!** The Ford this year is even steadier and easier to handle. This is due in part to new lower center of gravity and wider tread, and to new dual stabilizers and the torque-tube drive which make for better control on turns even at relatively high speeds.



**A** POWERFUL car with a powerful look . . . a quality car with a quality look . . . you'll find this new Ford both. With widened tread and a lower car, Ford designers have made the most of a chance to create massive new modern lines. And with them go strikingly rich new interiors. You ride in style in your new Ford . . . and its style is designed to *stay* up to date!



**N**EW FINISH, new dials, new beauty mark the new Super DeLuxe instrument panel. Rich wood-grain finish blends with plastic trim to give a stunning over-all effect.

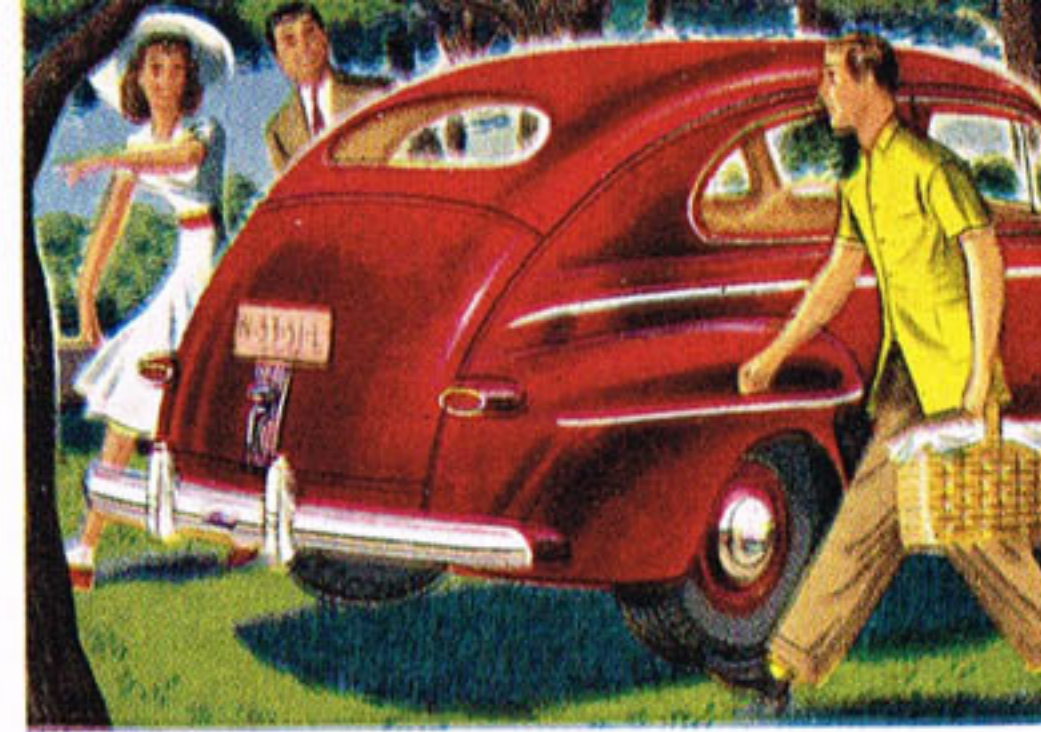

**A** BIG AND graceful looking car. Stone deflectors between bumpers and body protect the finish when driving on gravel roads. Bumpers are new and massive. The big one-piece rear window does its bit to help make driving easy, night or day.

## Style Steps Out in This Big Ford

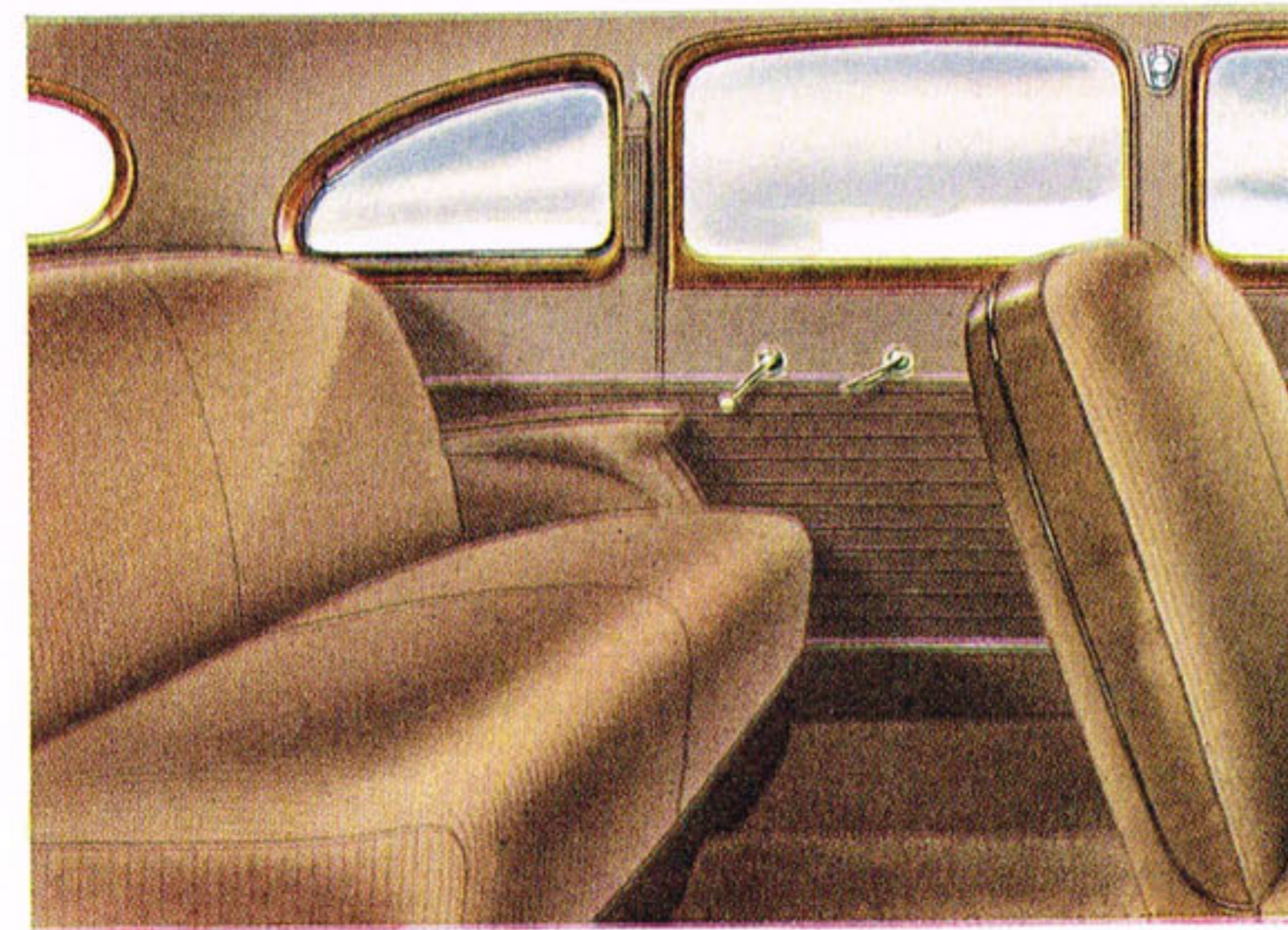
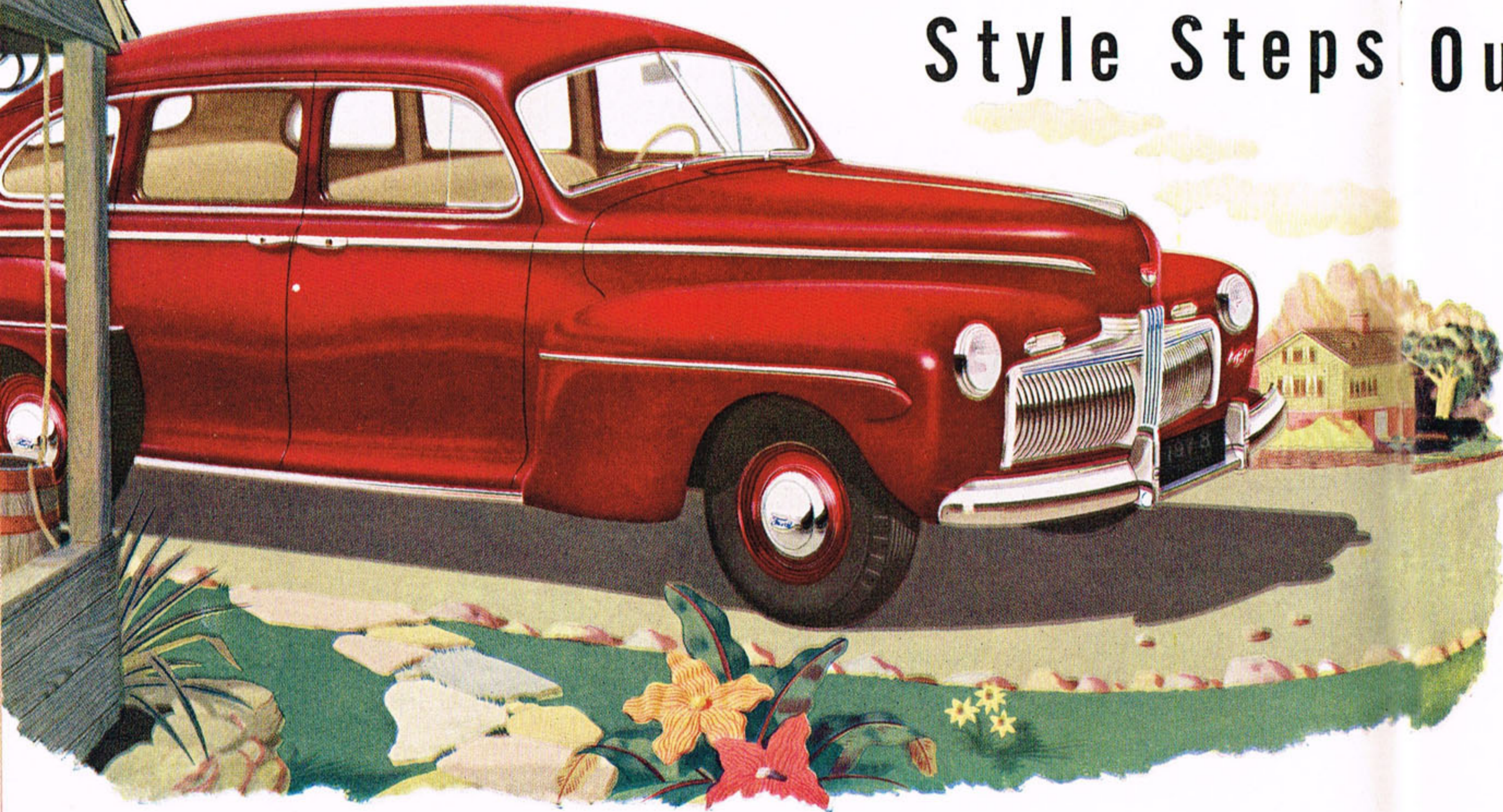

**T**HIS IS the 1942 Super DeLuxe Fordor Sedan. Material is broadcloth or mohair in a warm, practical-but-cheerful tone. Genuine leather combines with cloth for a new effect in arm rests, and artificial leather harmonizes with cloth on doors.

**N**EW IN THIS year's Ford cars are the cleverly concealed running boards. Bodies themselves swing wide to give roominess inside. Doors flange outward at the base to give a clean, trim gleaming side.

**A**LL MATERIALS are handled with good taste. Handles and window cranks combine bright metal with plastic. Genuine leather on arm rests serves a decorative as well as a useful purpose.

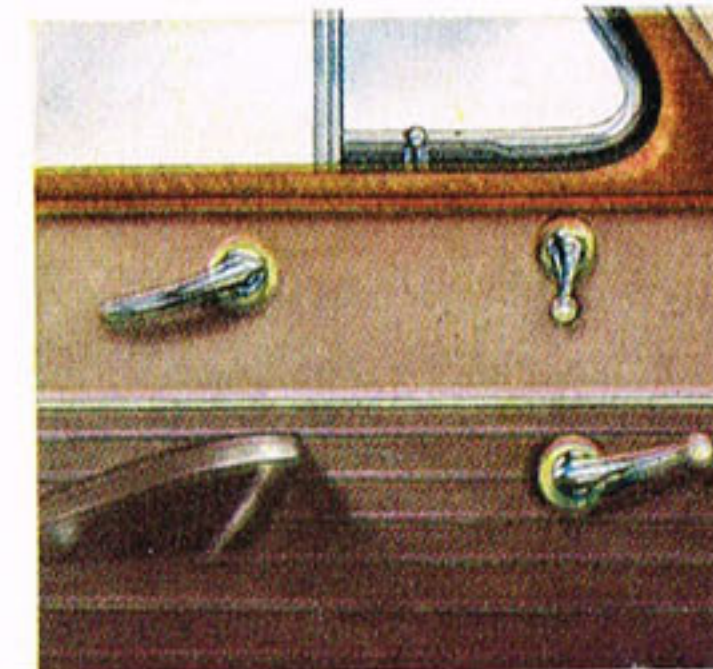

# New Ideas in Comfort for Cars So Low in Price

Try that "Great New Ford Ride"  
It's even Finer Still for 1942!

Get in—stretch out—plenty of Leg Room—Head Room. This Ford is Big where Bigness Counts!

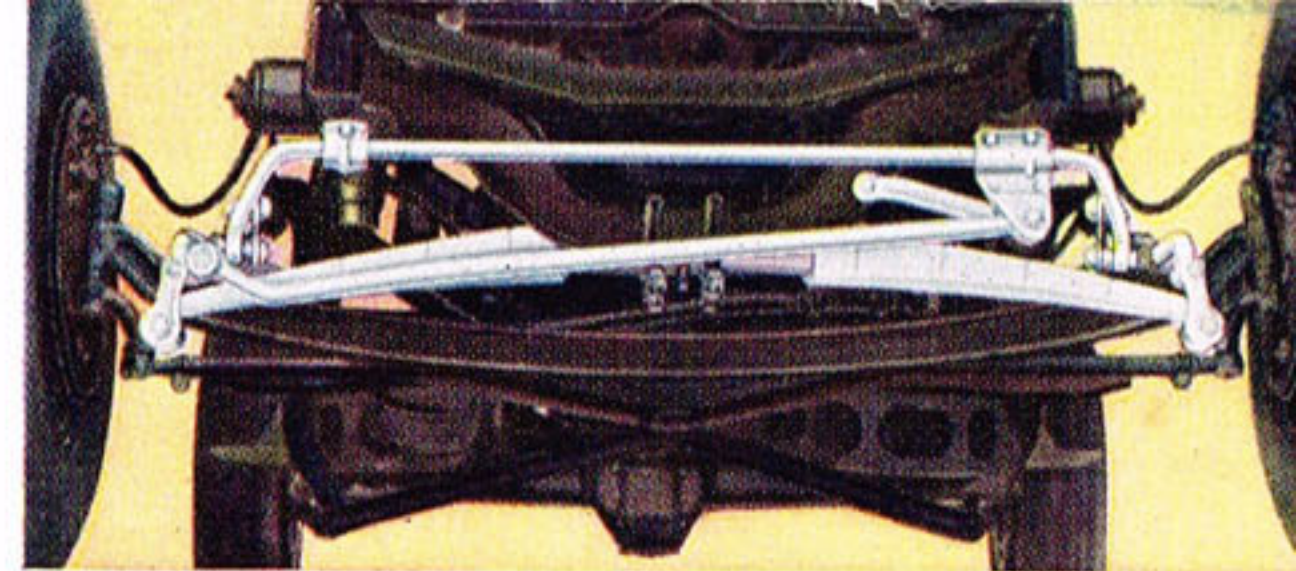

DUAL STABILIZERS mark an important improvement in the famous "Ford velvet ride." A track bar has been added to keep steering stable. The torsion bar controls sidesway.

THERE ARE 700 square inches of crystal-clear safety glass in the windshield alone, giving driver and passengers a broad, sweeping view.

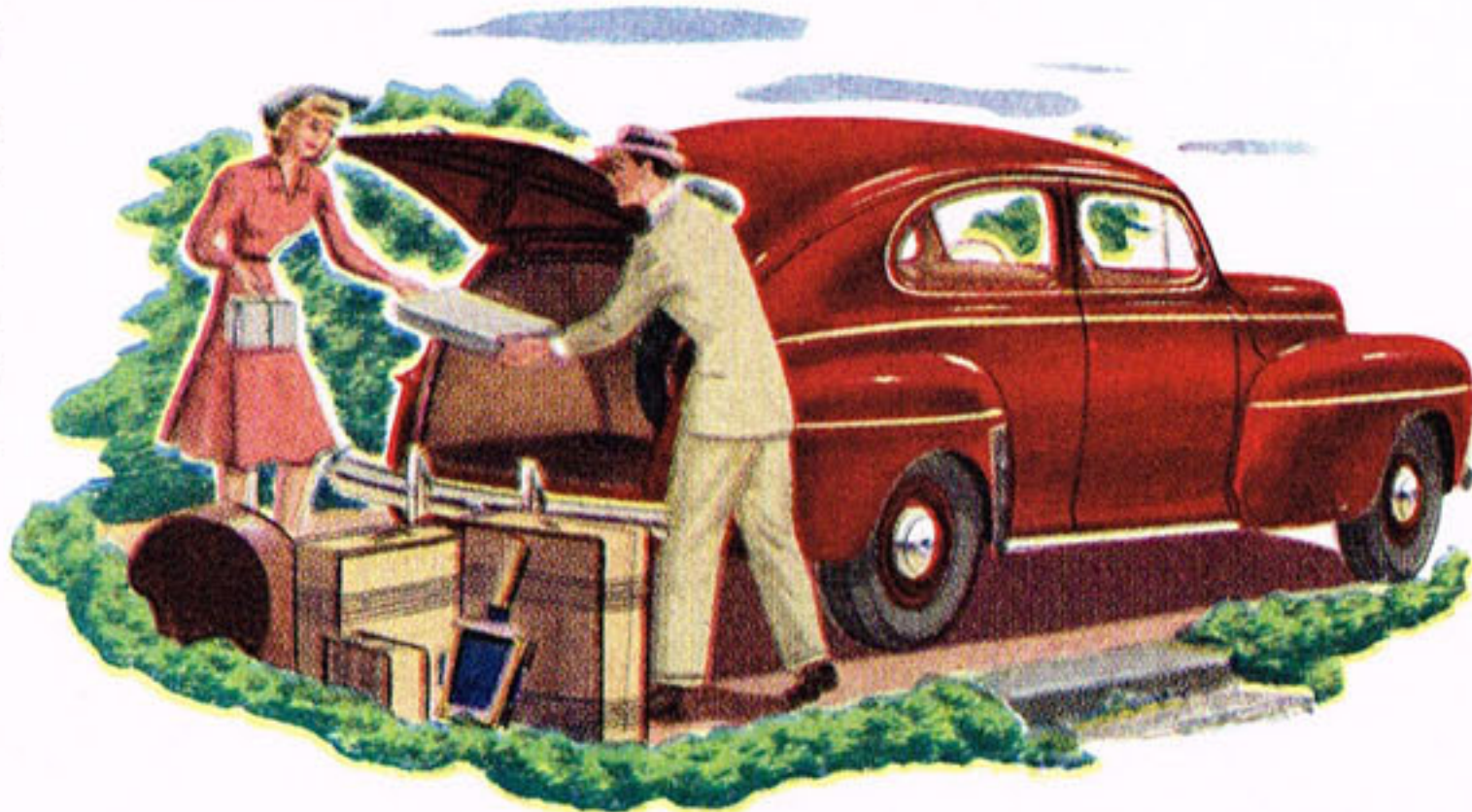

ROOM FOR passengers inside . . . room for their luggage at the rear! You'll be surprised at the size of your Ford luggage compartment. Spare tire is upright at the back—out of your way.

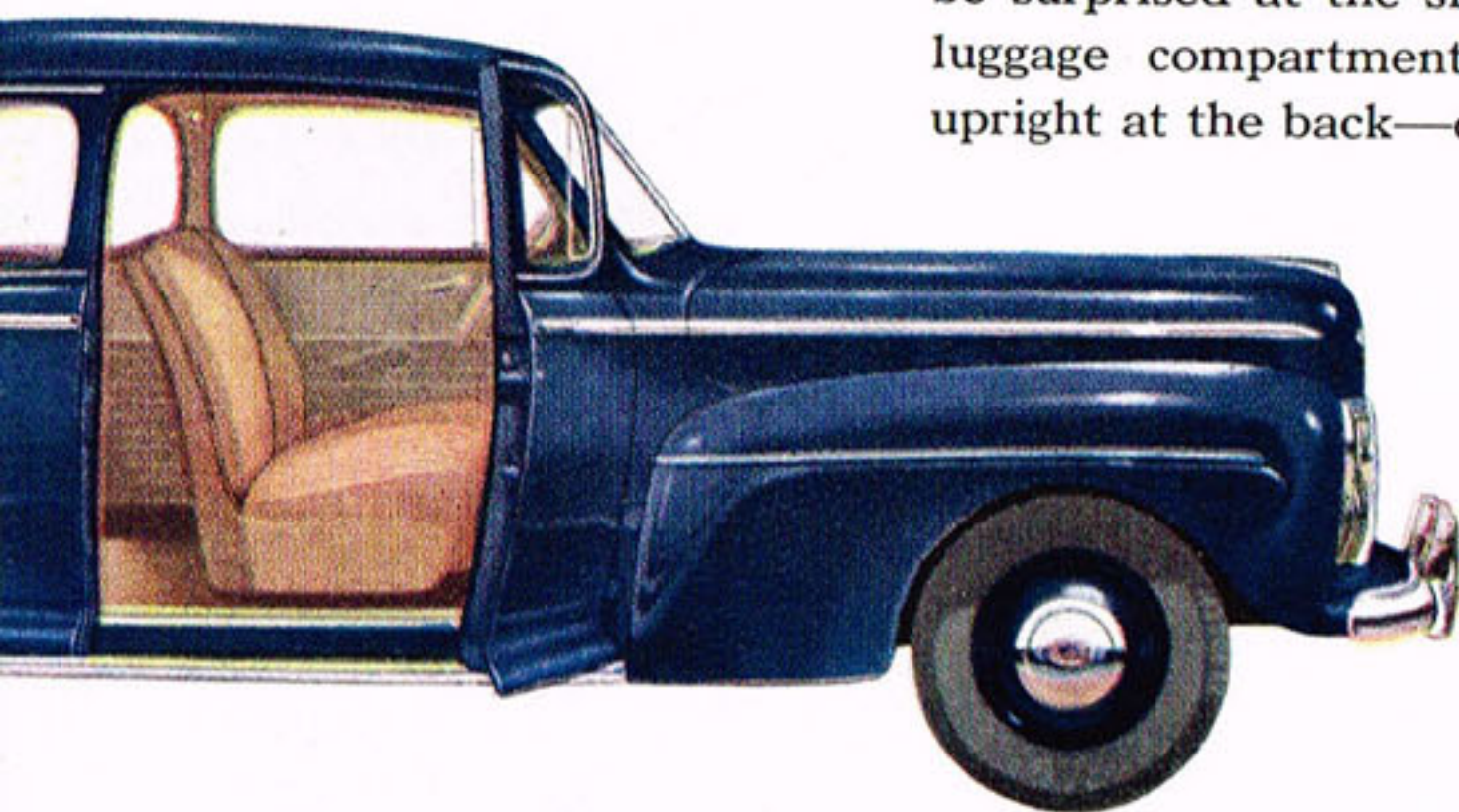

WIDE DOORS feature this big Ford car. Ample space to get in and out characterizes every Ford body type. The Tudor has door width of 3½ feet, with divided front seat backs.



UNTIL YOU get into a Ford and stretch out, you're going to find it hard to sense how big it is! There is plenty of comfort for three passengers on both the front and the rear seats.

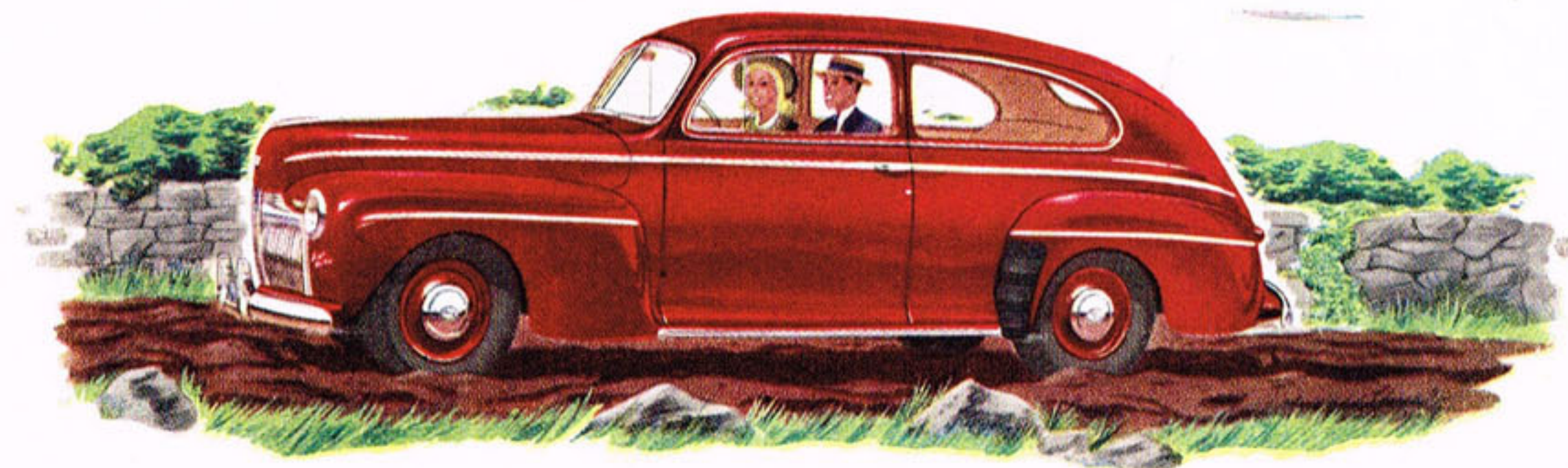

THE FORD springing system permits a springbase almost a foot longer than its wheelbase. Rear seat passengers ride forward of the rear axle, where the ride is best. For 1942, softer, longer, slow-motion springs give an even smoother Ford ride.

MAKING THE car lower and the tread wider for 1942 does something more than add to smart appearance. With center of gravity lower, the car "balances" better. With the wider tread, longer springs can be used for a still softer ride.

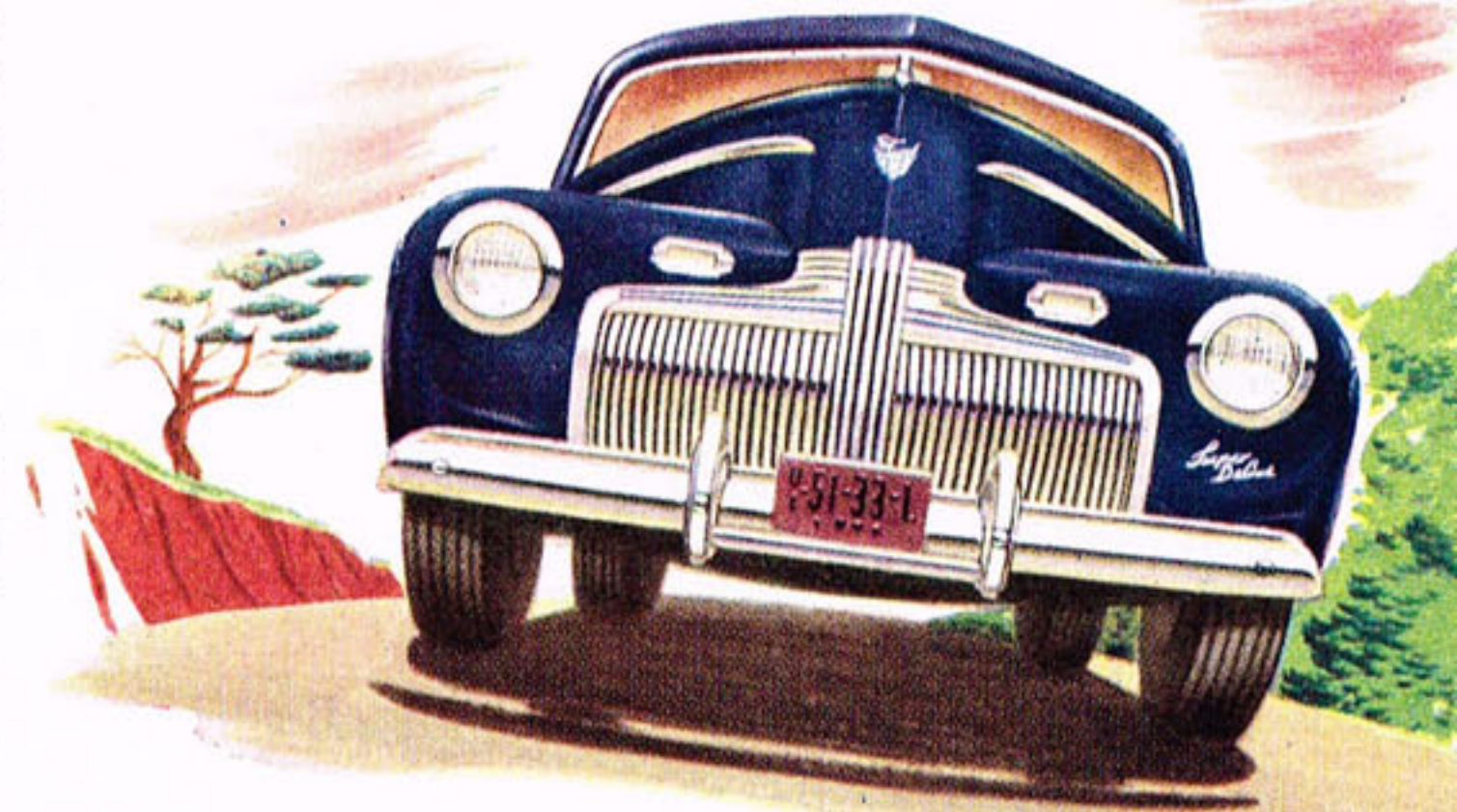



# NOW MORE THAN EVER—THE QUALITY CAR IN ITS FIELD

**NEW STYLING:** Bigger, more massive looking than ever before, providing maximum passenger room with large luggage space. New flared type bodies concealing running boards. Wide spaced Sealed-Beam Headlamps and new parking lights mounted between them in the new streamlined fenders. Door handles in line with belt molding. Body streamlining, tested in Ford Weather Tunnel.

**NEW RIDE:** Smooth "velvet" ride is the result of new longer, softer, slower action front and rear springs, which in the Super De Luxe are enclosed in fabric lined metal covers. These, combined with 125-inch springbase, super-sensitive double-acting hydraulic shock absorbers and lower center of gravity, set a new standard for comfort.

**NEW STABILIZERS:** A new improved torsion bar type of stabilizer reduces the sidesway on rough roads and turns. A new "track bar" stabilizes the steering and preserves the perfect alignment of the axle and frame. This greatly increases steering stability.

**NEW LOWER FRAME:** The new frame retains the welded one-piece X-member that forms deep box section side rails and gave 100% more stiffness last year. It is 1 inch lower, however, giving greater stability, more comfort and a long low appearance.

**BODY MOUNTING:** Super-size cushion rubber insulators for all closed body types eliminate any

metallic contact between the body and frame, thus blocking off road noise and chassis sounds. New rubber mounts for engine and exhaust system add still further to quiet operation.

**NEW BIG HYDRAULIC BRAKES:** 12-inch diameter brake drums and 162 square inches of lining area give quick easy stops and long brake life. Still less pedal pressure and quieter operation through detail improvements in mounting brake shoes. Parking brakes, on rear wheels, are cable controlled.

**90 HP V-8 ENGINE:** Only low price car to offer V-type 8-cylinder engine. Unusual economy obtained on both gasoline and oil. Fan raised for more efficient cooling. V-8 engine available in De Luxe and Super De Luxe models.

**90 HP "6" ENGINE:** The most modern Six in the low price field with a record for both economy and performance. Available in all Ford cars.

**NEW DRIVING EASE:** Finger-Tip Gearshift beneath two-spoke steering wheel retained. Linkage has been improved to give still easier shifting. Blocker-type silent shift transmission is continued. 18.2 to 1 steering gear ratio provides quick and effortless steering, especially when parking.

**TORQUE-TUBE DRIVE** with front radius rods. An important element in the Ford stabilized chassis. All driving and braking forces are transmitted directly to frame. Springs left free to support the load and cushion road shocks.

**3/4-FLOATING REAR AXLE:** Another reason for Ford reliability. Straddle-mounted driving pinion.

**BIG BATTERY:** 120 ampere hours. Big reserve of power for electrical accessories. Improved voltage regulator automatically controls generator output.

**BODY TYPES:** *Super De Luxe body types:* Tudor Sedan, Fordor Sedan, Coupe, Sedan-Coupe, Convertible Club Coupe, Station Wagon. *De Luxe body types:* Tudor Sedan, Fordor Sedan, Coupe, new Sedan-Coupe. *"Special" body types:* Tudor Sedan, Fordor Sedan, Coupe.

**NEW BRIGHT COLORS:** *Super De Luxe:* Choice of Moselle Maroon, Nile Blue Green, Fathom Blue, Florentine Blue, Newcastle Gray, Black. Wheels

body color, with striping. *De Luxe:* Newcastle Gray, Fathom Blue, Florentine Blue, Black. Wheels body color, without striping. *"Special":* Black only. All colors are enduring baked enamel. Fenders and other sheet metal parts are rust resistant. Fenders to match body color.

**UPHOLSTERY:** *Super De Luxe:* Choice of chevron gray striped mohair or broadcloth in closed cars. Golden tan, red, or blue genuine leather seats in Convertible Club Coupe. Golden tan genuine leather seats in Station Wagon. *De Luxe:* Choice of Taupe and Brown mohair or broadcloth.

**WHEELS:** Five. Pressed steel, curved disc type, with 4-inch width rims.

**TIRES:** 6:00-16 4-ply on passenger cars—6-ply on station wagons.

**DELUXE EQUIPMENT:** (Items marked asterisk \* are in Super De Luxe Types only.) Front and rear bumpers and four bumper guards. Spare wheel, tire and tube. Twin air-electric horns. Two combination tail lamps and stop lights. Dual windshield wipers with speed control on instrument panel. \*Electric lighter. Two sun visors. Foot control for headlight beams with indicator on instrument panel. Dimming control for instrument panel lights. Ignition keyhole light. Glove compartment with lock. \*Two ash trays in instrument panel. Leather-covered arm rests in rear seat of sedan types. Arm rest on driver's side of front seat. Remote control hood lock. Separate parking lamps. Plastic grille to cover speaker when radio is installed. Foot rests in Fordor Sedans. Friction type door checks. Automatic light in luggage compartment. Rubber mat on luggage compartment floor. \*30-hour clock. \*Horn ring on steering wheel. \*Crank control for front door ventilators. \*Ash tray in rear of Sedans. \*Trip mileage indicator with setting on instrument panel. \*Assist loops. \*Robe cord in Fordor Sedan. \*Leather-covered arm rests on both front doors. Bright chrome interior hardware. Black tires standard. White sidewall tires will be furnished at extra cost as long as they are available.

**ACCESSORIES:** Wide range. Designed especially for Ford cars. Available at moderate cost. Ford Adjust-O-Matic Radio with Foot Control and Touch-Bar Tuning. Improved Hot-Water and Hot-Air Heater-Defrosters. Ask for accessories folder showing complete line.

*The Ford Motor Company, cooperating to the fullest extent in the conservation of vital materials for National Defense, has made the cost of necessary material replacements secondary to the maintenance of high quality standards.*

*The right is reserved to change specifications, design or prices without incurring obligation.*

7451—8-41—PRINTED IN U. S. A.

