

2004 CHRYSLER TOWN & COUNTRY



From the creator of the world's first minivan comes the world's ultimate minivan. The Town & Country Limited from Chrysler. Sleek and stylish, with ergonomically refined seating, supple leathers and the safety of multistage air bags. Flexible and spacious, thanks to second-row seats that fully recline and a split-row bench that can be folded down or removed completely. You want the best for your family. We want the best for your family. The most awarded minivan on earth. Town & Country.



LIMITED IN BRIGHT SILVER METALLIC





Luxury car features in a minivan? Of course, this is the Chrysler Town & Country. Convenient features like available power adjustable pedals are built right in. Available with heated and leather-trimmed seating, it will have you thinking of it as the luxury car alternative.



STANDARD ON LIMITED, THREE-ZONE AUTOMATIC TEMPERATURE CONTROL KEEPS EVERYONE COMFORTABLE. CONVENIENCE ON YOUR KEY. LOCK AND UNLOCK THE DOORS, OPEN AND CLOSE THE AVAILABLE POWER SLIDING DOORS AND POWER REAR LIFTGATE. IF EQUIPPED, THE BUTTON FOR THE ADJUSTABLE PEDALS IS EASILY ACCESSIBLE ON THE STEERING COLUMN. BE SURE TO ASK ABOUT AVAILABLE SIRIUS SATELLITE RADIO*, WITH MORE THAN 100 PROGRAMMING CHOICES BEAMED DIRECTLY TO YOUR MINIVAN. THE AVAILABLE MOONROOF OPENS TO BATHE THE CABIN IN SUNLIGHT AND ALLOWS FRESH AIR TO CIRCULATE.

RIGHT: AVAILABLE ELECTROLUMINESCENT INSTRUMENT CLUSTER.

*Mopar option; hardware and subscription extra. Channel information is correct at time of printing. Visit sirius.com for a current channel listing. Not available in Alaska or Hawaii.

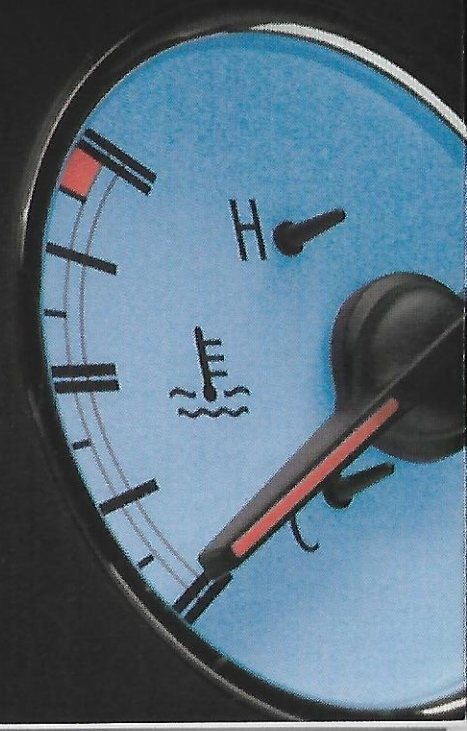
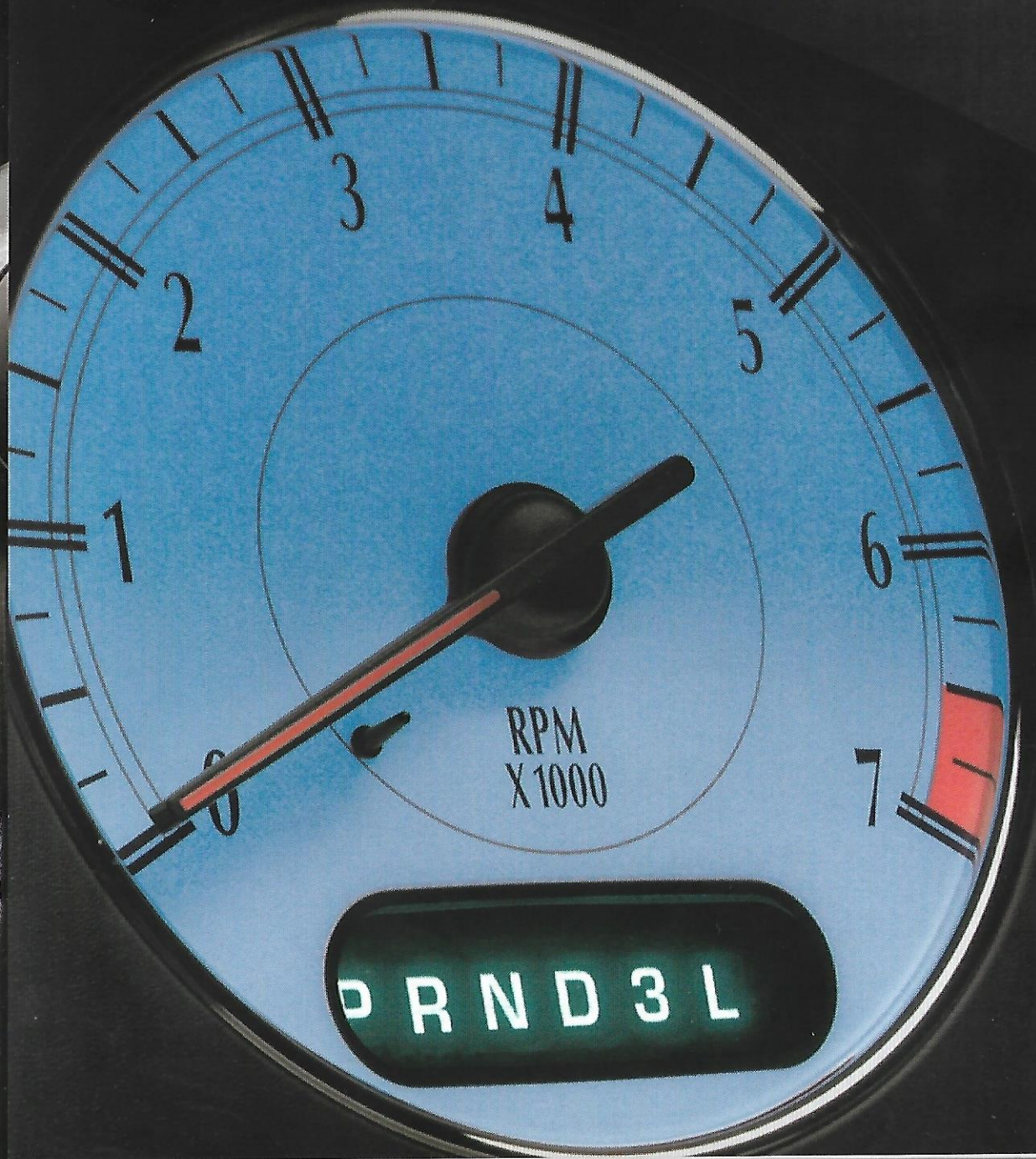



LIMITED INSTRUMENT PANEL WITH STANDARD NAVIGATION SYSTEM IN MEDIUM SLATE GRAY

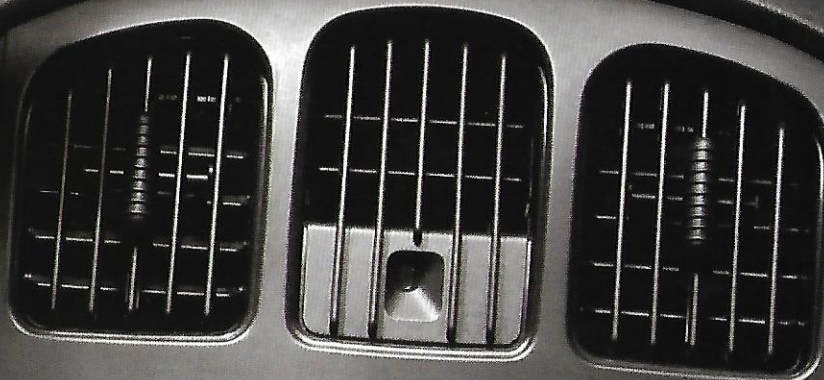

DVD
PUSH ON/VOL H M
AM FM
CD AUX
TONE
SCAN
NAV
EJECT
1 DISC TUNE
2
3
RND SEEK
DISC
3.5
PDS

1.6 miles
PRAIRIE AVE 12:00
W 190TH ST FM 89.0MHz
MAP

HI
PWR AUTO 72 AUTO 78 76
LO
FRONT
DRIVER REAR PASS

Town & Country helps you make the most of all that time you spend on the road. Whether you take your family on an extended vacation or you're just making your way to work, Town & Country will get you there in comfort. And, most importantly, with a sense of inner calm.



AVAILABLE REAR-SEAT ENTERTAINMENT SYSTEM FEATURES A FOLD-DOWN SCREEN, WIRELESS HEADPHONES AND AVAILABLE SIX-DISC CD/DVD CHANGER, SO YOUR FAMILY CAN ENJOY THEIR FAVORITE MUSIC OR MOVIES.

AVAILABLE MOVABLE CENTER CONSOLE HAS A POWER OUTLET AND LOCKABLE STORAGE FOR YOUR CDS OR CELL PHONE.

AVAILABLE OVERHEAD CONSOLE FEATURES TEMPERATURE DISPLAY, COMPASS, TRIP COMPUTER AND SWITCHES FOR AVAILABLE HOMELINK®, POWER DOORS, LIFTGATE AND MOONROOF.





LIMITED LEATHER-TRIMMED INTERIOR WITH PREFERRED SUEDE* ACCENTS IN MEDIUM SLATE GRAY

Properly secure all cargo.



Load it up. Move it out. Keep your appointment. Make your date. Town & Country has the interior cargo- and passenger-carrying flexibility to keep your life on track. Town & Country's available Quad Command seats are easily removable and roll away when you need extra room.



WITH THE AVAILABLE QUAD COMMAND SEATS, INTEGRATED CHILD SEAT*, MOVABLE CENTER CONSOLE AND 50/50 SPLIT FOLD-AND-TUMBLE REAR BENCH SEATING COMBINATION, 972 INTERIOR CONFIGURATIONS ARE POSSIBLE. THE OPTIONAL 50/50 BENCH SEAT FOLDS AND TUMBLES TO HELP YOU CARRY PEOPLE AND/OR CARGO. TOWN & COUNTRY OFFERS THE SPACE AND CARGO-CARRYING VERSATILITY TO HELP YOU LIVE YOUR LIFE. THE AVAILABLE POWER REAR LIFTGATE OPENS AND CLOSES WITH THE KEY FOB OR BUTTON ON THE OVERHEAD CONSOLE.

*For children at least one year old, weighing between 22 and 50 pounds and no more than 47 inches tall.



LX CLOTH INTERIOR IN KHAKI

Properly secure all cargo.

Safety and security are important whenever you venture out with your family. Standard Next Generation multistage front air bags* and available side-impact air bags* for front-seat occupants have helped Town & Country receive the government's highest side crash rating — ★★★★★†. You'll feel better knowing you and your family benefit from these comfort and safety features.

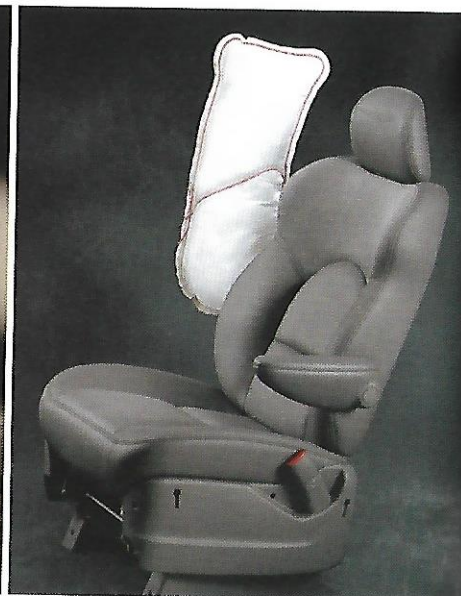
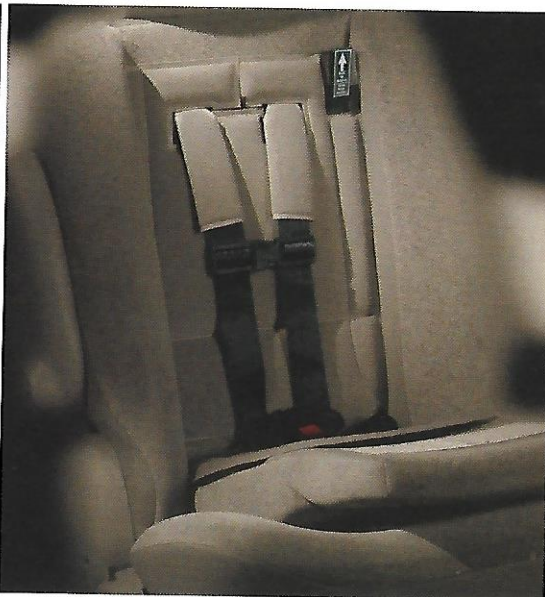
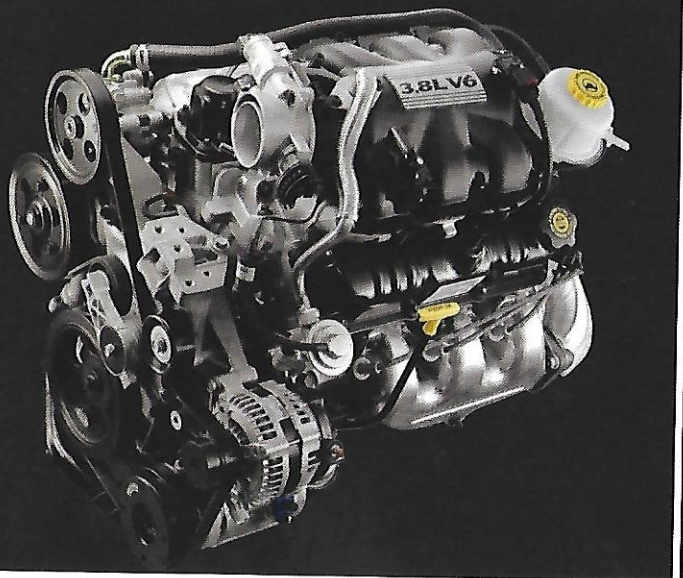

STANDARD ON TOURING, eX AND LIMITED, THE 3.8-LITER SMPI V6 ENGINE OFFERS AN IMPRESSIVE 215 HORSEPOWER. AVAILABLE INTEGRATED CHILD SEAT* IS LOCATED IN THE PASSENGER-SIDE SECOND-ROW BUCKET SEAT. AVAILABLE FRONT-SEAT SIDE-IMPACT AIR BAGS* HELP PROTECT FRONT-SEAT PASSENGERS IN A SIDE-IMPACT COLLISION.

*Certified to the Federal Regulations that allow less-forceful air bags. Always use seat belts. Children 12 and under should always be in a backseat correctly using an infant or child restraint system, or the seat belt positioned correctly for the child's age and size. †Five-Star rating based on the 2003 model year crash test. Long-wheelbase models only. ‡For children at least one year old, weighing between 22 and 50 pounds and no more than 47 inches tall.



LX IN BRIGHT SILVER METALLIC



TOWN & COUNTRY STANDARD WHEELBASE IN MIDNIGHT BLUE.

Every Town & Country we produce offers a level of uncompromising quality and performance. Whether you decide on the fully loaded, top-of-the-line Limited, the well-equipped, value-leading standard wheelbase Town & Country, or something in between, you'll find one to fit your family's lifestyle and your budget.

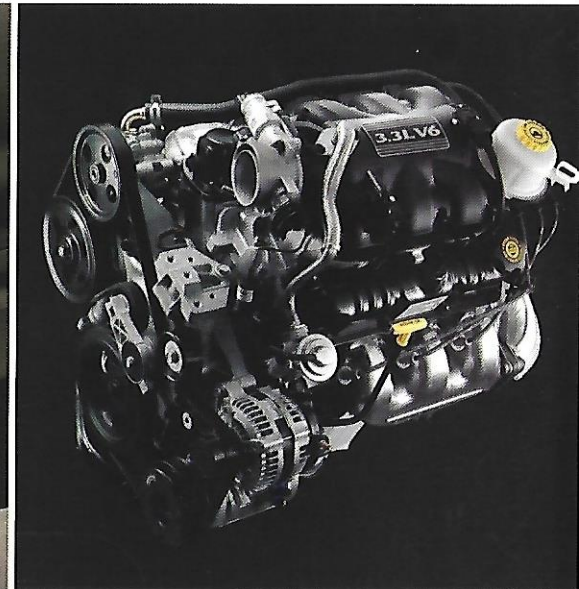

TOWN & COUNTRY INSTRUMENT PANEL PUTS ALL THE NECESSARY CONTROLS EASILY WITHIN YOUR REACH*
TOWN & COUNTRY'S 3.3-LITER V6 PROVIDES 180 HORSEPOWER AND EXCELLENT TORQUE OVER A WIDE RANGE.

*Some optional features shown.

EXTERIOR COLORS

BRIGHT SILVER
METALLIC²

BRILLIANT
BLACK CRYSTAL
PEARL COAT^{2,3}

BUTANE BLUE
PEARL COAT¹

INFERNO RED
TINTED PEARL COAT³

LIGHT ALMOND
PEARL METALLIC⁴

ONYX GREEN
PEARL COAT³

SATIN JADE
PEARL COAT¹

DEEP MOLTEN RED
PEARL COAT¹

STONE WHITE³

MIDNIGHT BLUE
PEARL COAT³

GRAPHITE
METALLIC²

ALL EXTERIOR COLORS FEATURE A CLEAR COAT FINISH.

¹AVAILABLE WITH MEDIUM SLATE GRAY INTERIOR. ²AVAILABLE WITH PLATINUM SERIES.

³AVAILABLE WITH KHAKI AND MEDIUM SLATE GRAY INTERIOR. ⁴AVAILABLE WITH KHAKI INTERIOR. NOT AVAILABLE ON LIMITED.

INTERIOR COLORS, FABRICS, AND WHEELS

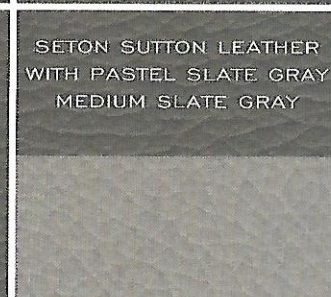
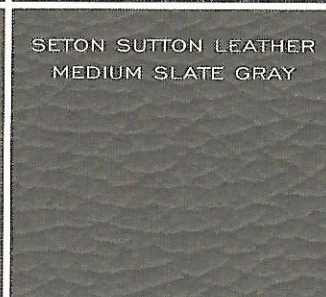
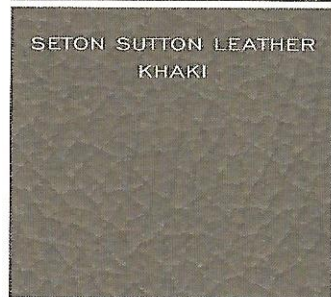
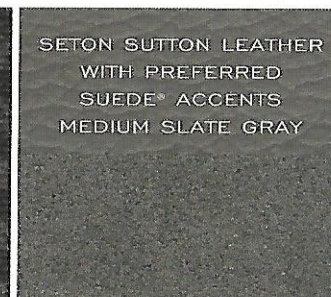
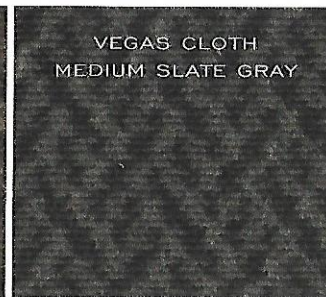
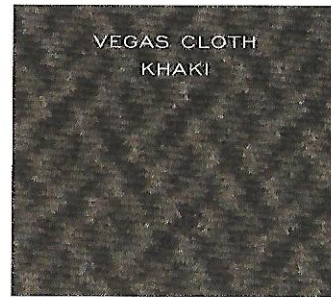

VEGAS CLOTH AVAILABLE IN KHAKI OR MEDIUM SLATE GRAY; STANDARD ON TOWN & COUNTRY, LX, TOURING AND EX. SETON SUTTON LEATHER-TRIM AVAILABLE IN KHAKI OR MEDIUM SLATE GRAY; OPTIONAL ON TOWN & COUNTRY TOURING AND EX. SETON SUTTON LEATHER TRIM WITH PREFERRED SUEDE® ACCENTS AVAILABLE IN MEDIUM SLATE GRAY; STANDARD ON LIMITED. SETON SUTTON LEATHER-TRIM AVAILABLE IN MEDIUM SLATE GRAY WITH PASTEL SLATE GRAY INSERTS INCLUDED WITH PLATINUM SERIES. WHEELS (TOP TO BOTTOM): 15-INCH SOLARA WHEEL COVER STANDARD ON TOWN & COUNTRY, LX; 16-INCH CONSTELLATION ALUMINUM STANDARD ON TOURING, EX; 16-INCH CONSUL PLATINUM-CLAD ALUMINUM INCLUDED WITH PLATINUM SERIES; 16-INCH CONSUL CHROME-CLAD ALUMINUM STANDARD ON LIMITED;

TOWN & COUNTRY (STANDARD WHEEL BASE)

Air Bags – Next Generation driver and front-passenger multistage*

Air Conditioning

Brake-Park Interlock – (Cannot shift out of Park unless brake pedal is applied)

Brakes – Front disc/rear drum

Cargo Net – Between front seats

Child Seat Anchor System (LATCH) – Lower child seat anchors and upper tether anchors help ease the installation of compatible aftermarket child seats

Defroster – Electric, rear

Door Locks – Power

Engine – 3.3-liter V6

Floor Mats – Front and intermediate

Glass – Sunscreen

Grocery Bag Hooks – Rear seatback

Remote Keyless Entry

Seating – Deluxe two-passenger intermediate and three-passenger rear bench seat; Easy Out Roller Seats®

Sound System – AM/FM stereo radio with CD player and four speakers

Speed Control

Steering Column – Tilt

Storage – Lockable drawer under front-passenger seat

Tires – 215/70 R15 BSW all-season

Transmission – Four-speed automatic

Windows – Power, with driver's one-touch-down

Wipers – Variable intermittent front and intermittent rear

Wheel Covers – 15-inch Solara

TOWN & COUNTRY LX

Includes all Standard Wheel Base features

PLUS :

Brakes – Front disc/rear drum with antilock

Mirrors

– Power heated exterior

– Illuminated visor/vanity mirrors

Seats – Intermediate Quad Command bucket seats and rear three-passenger bench seat

STANDARD WHEEL BASE OPTIONS

Adjustable Pedals – Power

Air Bags – Supplemental side, mounted in front seats*

Brakes – Four-wheel antilock

Door – Power passenger-side sliding

Engine Block Heater

Entertainment Group #1 – Includes single-disc DVD player and fold-down seven-inch screen (late availability)

Popular Equipment Group – Includes overhead console, roof rack, illuminated visor/vanity mirrors, power heated exterior mirrors, Dual Zone air conditioning, AM/FM cassette/CD player with six speakers

Seating

– Eight-way power driver's seat

– Two-passenger intermediate bench with Integrated Child Seats†

– Intermediate Quad Command bucket seats and rear 50/50 split-bench seat

Sound System

– AM/FM stereo radio with in-radio six-disc CD changer and six speakers

LX OPTIONS

Includes all Standard Wheel Base options

PLUS :

Dual Power Sliding Door Group – Includes driver and passenger-side power sliding doors and overhead console with trip computer and HomeLink®

Popular Equipment Group – Includes four-wheel disc brakes, rear split-bench seat, roof rack, tachometer, overhead console, Three-Zone manual temperature control air conditioning, AM/FM cassette/CD player with six speakers

Rear Seat Video System™ and Six Disc CD/DVD

Changer – Includes fold-down seven-inch screen, wireless remote control, wireless headphones and rear audio system

Roof Rack

Seating

– Intermediate Quad Command bucket seats with one Integrated Child Seat† and rear 50/50 split-bench seat

Trailer Tow Prep Group – Includes heavy-duty engine cooling, trailer-tow wiring harness, load-leveling and height control suspension and full-size spare tire

TOWN & COUNTRY TOURING/EX/TOURING ALL-WHEEL DRIVE

Includes all LX standard features

PLUS :

Air Conditioning – Three-Zone manual control
Assist Handles – Overhead, intermediate and rear row
Brakes – Four-wheel disc with antilock
Console – Overhead with trip computer, HomeLink® and compass/temperature display
Doors – Power driver- and passenger-side sliding
Engine – 3.8-liter V6
Instrument Cluster – Tachometer
Liftgate – Power
Molding – Body-color bodyside
Power Outlet – Auxiliary, in instrument panel
Roof Rack

Seating

- Eight-way power driver's seat
- Intermediate bucket seats and rear 50/50 split-bench seat

Sound System

- AM/FM stereo radio with cassette, CD player and six speakers
- Steering wheel-mounted audio controls

Steering Wheel

 – Leather-wrapped

Suspension – Load leveling and height control (All-Wheel Drive only)

Tire Pressure Monitoring System (late availability)

Tires – 215/65 R16 LBL all-season

Traction Control – Low-speed (front-wheel drive only)

Wheels – 16-inch Constellation aluminum wheel

TOURING/EX/TOURING ALL-WHEEL DRIVE OPTIONS

Includes all LX options

PLUS :

Leather Interior Group – Includes leather-trimmed seats, Three-Zone Automatic Temperature Control with particulate air/odor filter, driver's lumbar support, four-way power front-passenger seat, Electronic Vehicle Information Center, heated front seats

Luxury Group – Includes center movable/removable console, security alarm, electrochromic rearview mirror, automatic headlamps, electroluminescent instrument cluster, fog lamps, Infinity Acoustic 10™ speaker system, power adjustable pedals, bodyside cladding

Moonroof – Power

Platinum Series (Touring only) – Includes rear cargo organizer, center movable/removable console, special two-tone leather-trimmed seating, body-color roof rack, special floor mats and badging, silver instrument panel accents,

chrome inside front door handles, bodyside cladding with bright insert, Rear Seat Video System™, in-dash six-disc CD/DVD changer, 16-inch platinum-clad aluminum wheels

Premium Group (Requires Platinum Series) – Includes electroluminescent instrument cluster, fog lamps, security alarm, power adjustable pedals

Sound System

- AM/FM stereo radio with Navigation system and in-dash six-disc CD/DVD changer (requires Luxury Group or Premium Group)

Storage

- Center movable/removable console (Touring only)
- Rear cargo organizer (front-wheel drive only)

Tires – Full-size spare

TOWN & COUNTRY LIMITED/LIMITED ALL-WHEEL DRIVE

Includes all Touring/eX Standard Features

P L U S :

Adjustable Pedals – Power

Air Bags – Supplemental side, mounted in front seats*

Air Conditioning – Three-Zone Automatic Temperature Control with particulate air/odor filter

Chrysler Memory System – Includes settings for radio, driver's seat and driver-side mirror

Cladding – Bodyside cladding with bright insert

Console – Overhead with Electronic Vehicle Information Center

Door Trim – Preferred Suede® accents and bright door handle

Fog Lamps

Headlamps – Automatic

Instrument Cluster – Electroluminescent

Mirrors – Electrochromic rearview and driver-side exterior

Roof Rack – Body-color

Seating

- Four-way power front-passenger
- Heated front seats
- Driver's lumbar support
- Leather seat trim with Preferred Suede accents

Security Alarm

Sound System – AM/FM stereo radio with Navigation system and in-dash six-disc CD/DVD changer with Infinity Acoustic 10™ speaker system

Storage – Center movable/removable console

Suspension – Load leveling and height control (All-Wheel Drive only)

Wheels – 16-inch Consul chrome-clad aluminum

LIMITED/LIMITED ALL-WHEEL-DRIVE OPTIONS

Moonroof – Power

Tires – Full-size spare

Trailer Tow Prep Group – Includes heavy-duty engine cooling, trailer-tow wiring harness, load-leveling and height control suspension and full-size spare tire

*Certified to the Federal Regulations that allow less forceful front air bags. Always use seat belts. Children 12 and under should always be in a backseat correctly using an infant or child restraint system, or the seat belt positioned correctly for the child's age and size.
†For children at least one year old, weighing between 22 and 50 pounds and no more than 47 inches tall.

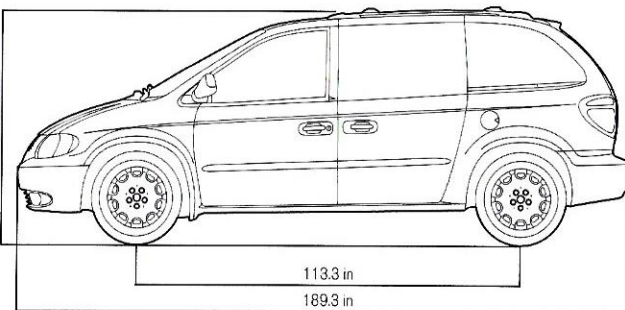
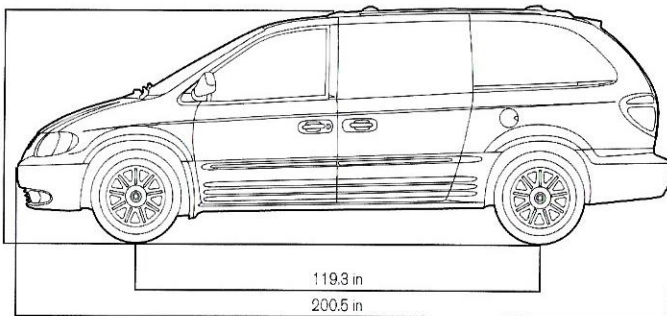
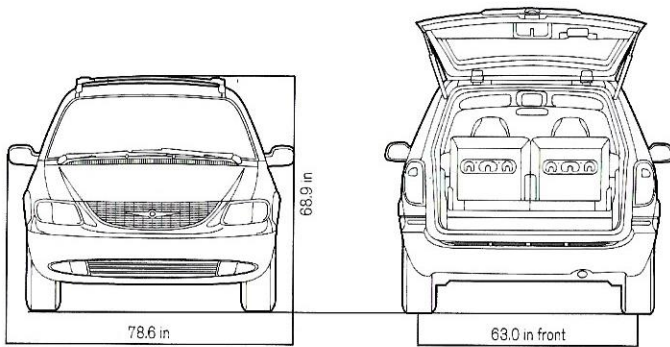

The specifications on these pages will help you choose a model and identify any preferred options. Detailed prices, current incentives and specifications are available through the resources listed below. Whether you prefer to ask your dealer, visit our Web site, or give us a call, we're here to help you.

VISIT YOUR DEALER. Your Chrysler dealer's knowledgeable and professionally trained staff will guide you through the shopping process with expert advice.

VISIT CHRYSLER.COM. Our Web site offers detailed information on all Chrysler products. You can virtually assemble any car or minivan you like...choose the model with your favorite color combinations, equipment and features – and then price it all out.

CALL 1-800-CHRYSLER. Our friendly and knowledgeable product information specialists are available seven days a week, 8 a.m. – midnight (EST) to answer your questions.

WARRANTY. All new Chrysler vehicles are covered by a 3/36 Basic Limited Warranty and a 7/70 Powertrain Limited Warranty. Ask your dealer for additional details and a copy of these Limited Warranties. A deductible applies to the 7/70 Powertrain Limited Warranty.



FINANCING OPTIONS. Chrysler Financial, a member of the DaimlerChrysler Services Group, offers flexible payment plans and financing products to qualified buyers. Ask your Chrysler dealer to help you arrange a Chrysler Financial financing or leasing plan that meets your driving needs and your lifestyle. To learn more, visit chryslerfinancial.com. Once you're there, you can use our payment estimator, determine which vehicles fit your budget, and apply for pre-approval.

All product illustrations, specifications and competitive comparisons are based upon current information at the time of publication approval. Although descriptions are believed correct, complete accuracy cannot be guaranteed. DaimlerChrysler reserves the right to make changes at any time, without notice or obligation, in prices, specifications, equipment, colors and materials, and to change or discontinue models. Some of the equipment shown or described throughout this catalog is available at extra cost. See your dealer for the latest information.

Easy Out Roller Seats and Rear Seat Video System are trademarks of DaimlerChrysler Corporation.
 HomeLink is a registered trademark owned by Johnson Controls, Inc.
 Preferred Suede is a registered trademark of Milliken & Co.
 © 2003 SIRIUS Satellite Radio, Inc.
 Infinity and Infinity Acoustic 10 are trademarks of Harman International Industries, Inc.

CHRYSLER



CHRYSLER.COM

800.CHRYSLER