

1939

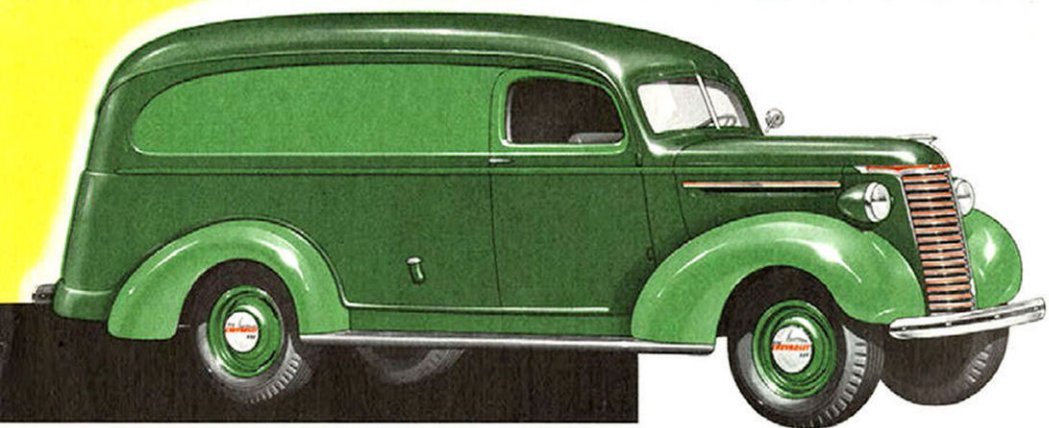

CHEVROLET
TRUCKS

CHEVROLET PANEL TRUCKS



LIGHT DELIVERY PANEL—All-steel construction, with one-piece steel roof . . . Fully streamlined . . . Continuous sign panel . . . Equipped with shock absorbers and ride stabilizer . . . Combines large loading space with speedy efficiency . . . Wheelbase, 113½ inches.

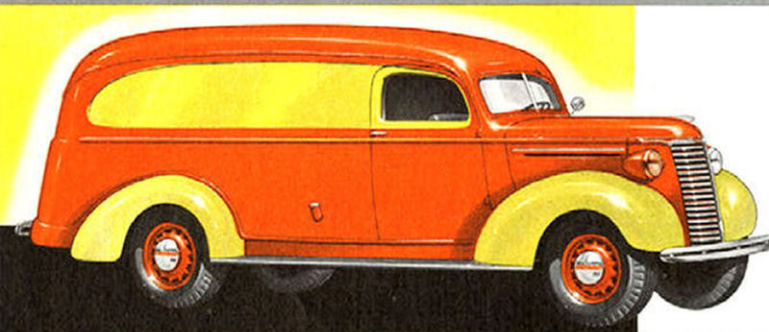

THREE-QUARTER-TON PANEL

—Modernly styled, with all-steel body and top . . . Wood floor with steel skid strips . . . Stylish and distinctive in appearance . . . Wheelbase, 123¾ inches.

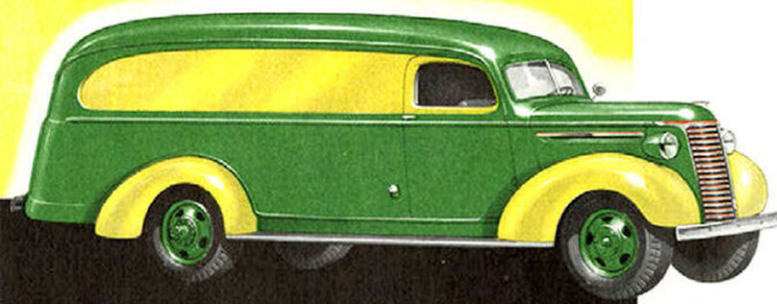

HEAVY DUTY PANEL—Capacity, 1½ tons . . . Large cargo space, with wide rear opening . . . All-steel body, one-piece steel roof . . . Full-length advertising panel . . . Wheelbase, 133 inches.

CHEVROLET PANEL BODY FEATURES

1 All-Steel Construction—All structural parts are steel, reinforced with ribs and braces. The floor is of wood, for long life. Rear pillars, relocated, give a wider opening.

2 Larger Door Opening—Improved design gives more space and facilitates loading.

3 Rear Door Pillars—A new design, with the pillars canted, gives a wider door opening and closer fit.

4 Insulation—Panels and steel roof are insulated against heat and noise.

5 Improved Seat—Cushions are padded with interlaced hair impregnated with latex. The seat is adjustable over a three-inch range.

6 Rear Door Hinges—The hinge pins are larger and are oil grooved for improved operation.

7 Dome Light—Fully illuminates load compartment and driver's compartment.

8 Body Braces—Attached underneath, they leave the floor unobstructed.

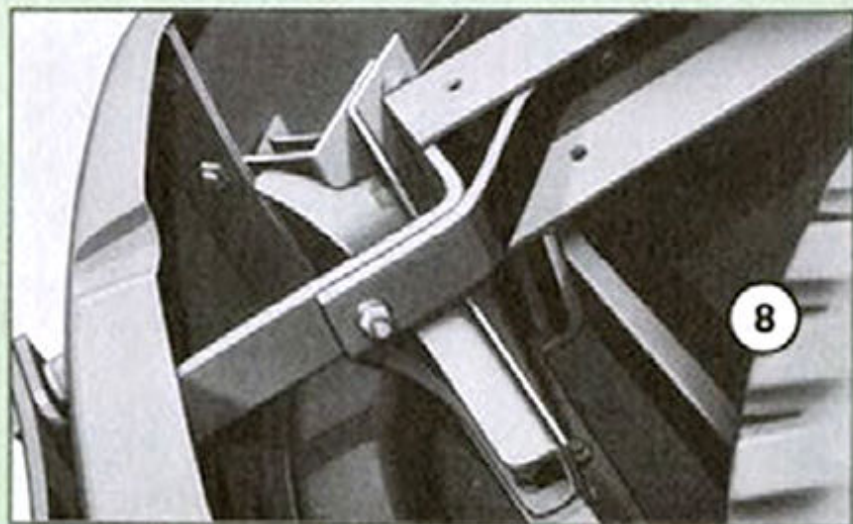
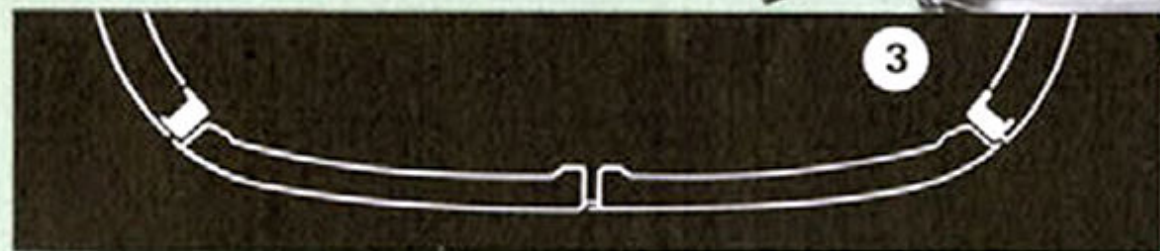
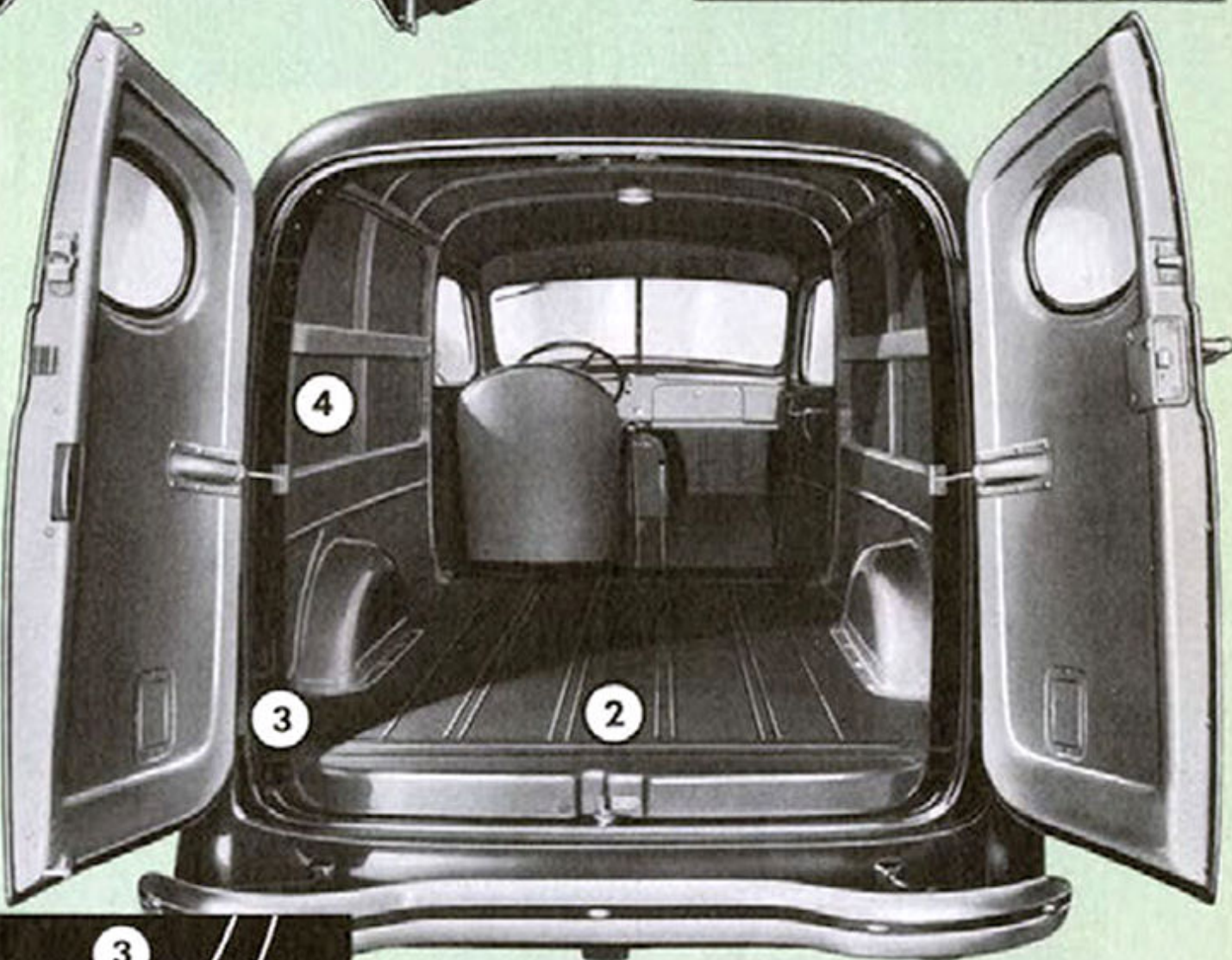
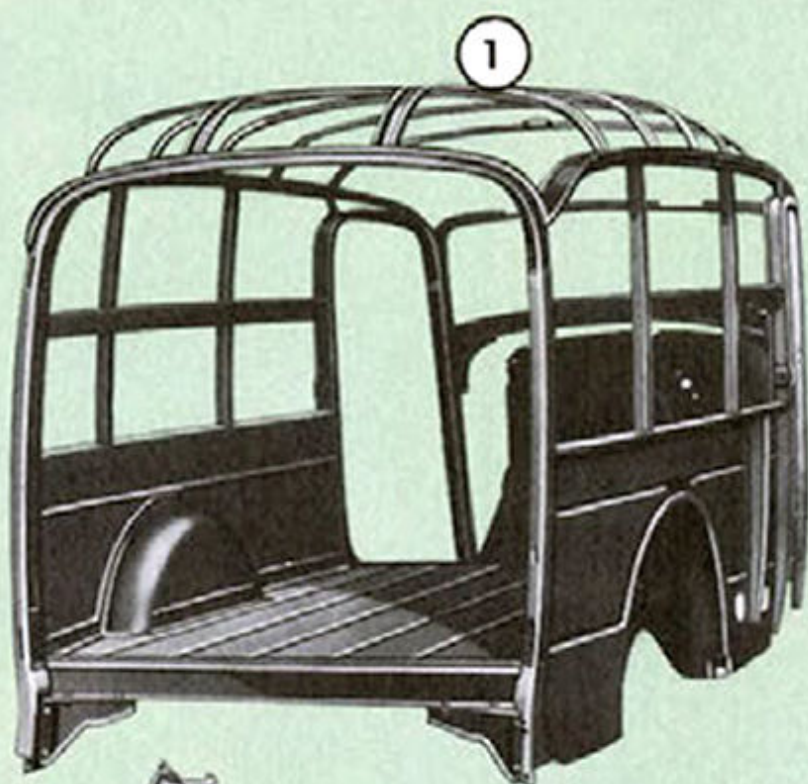

CHEVROLET CANOPY EXPRESS

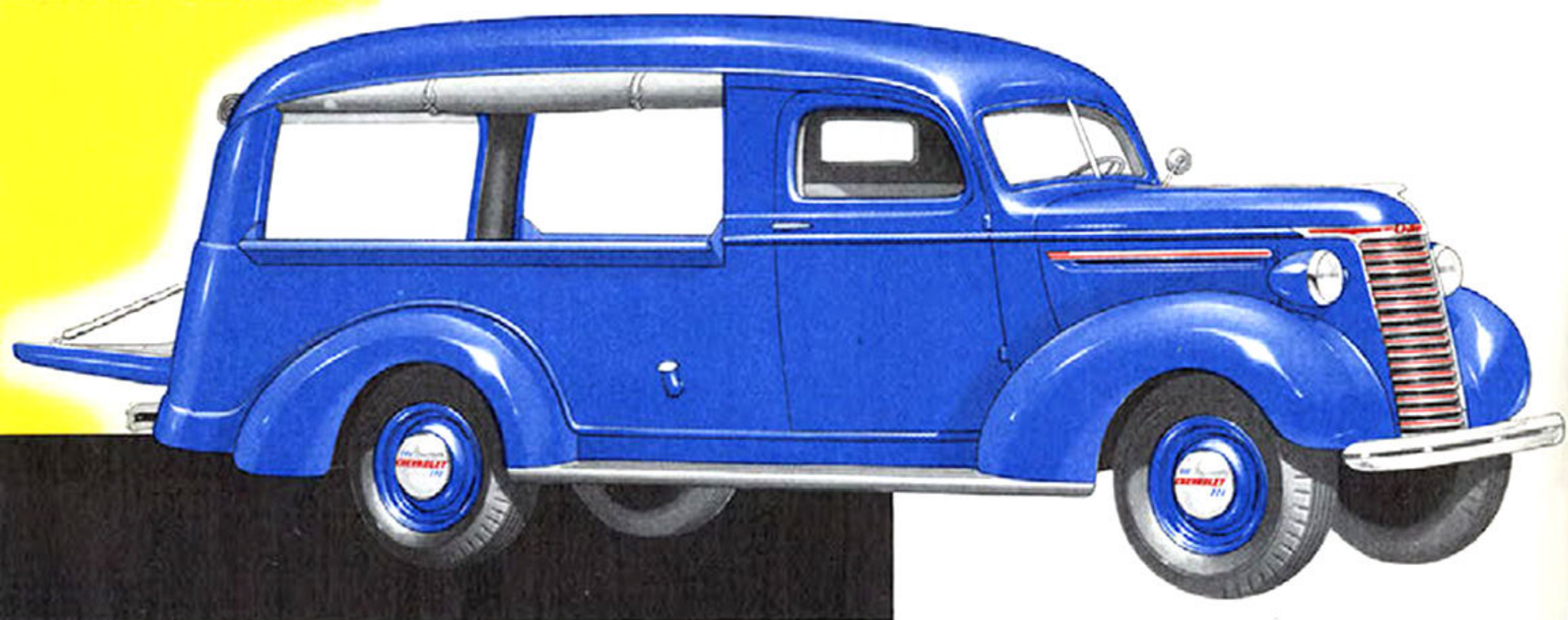

LIGHT DELIVERY CANOPY EXPRESS—All-steel body with one-piece roof . . . Roll curtains for weather protection; heavy wire mesh screens optional at slight extra cost . . . Substantial flare boards, with tubular edge . . . Easy action slam-type tail gate . . . Wheelbase, 113½ inches.

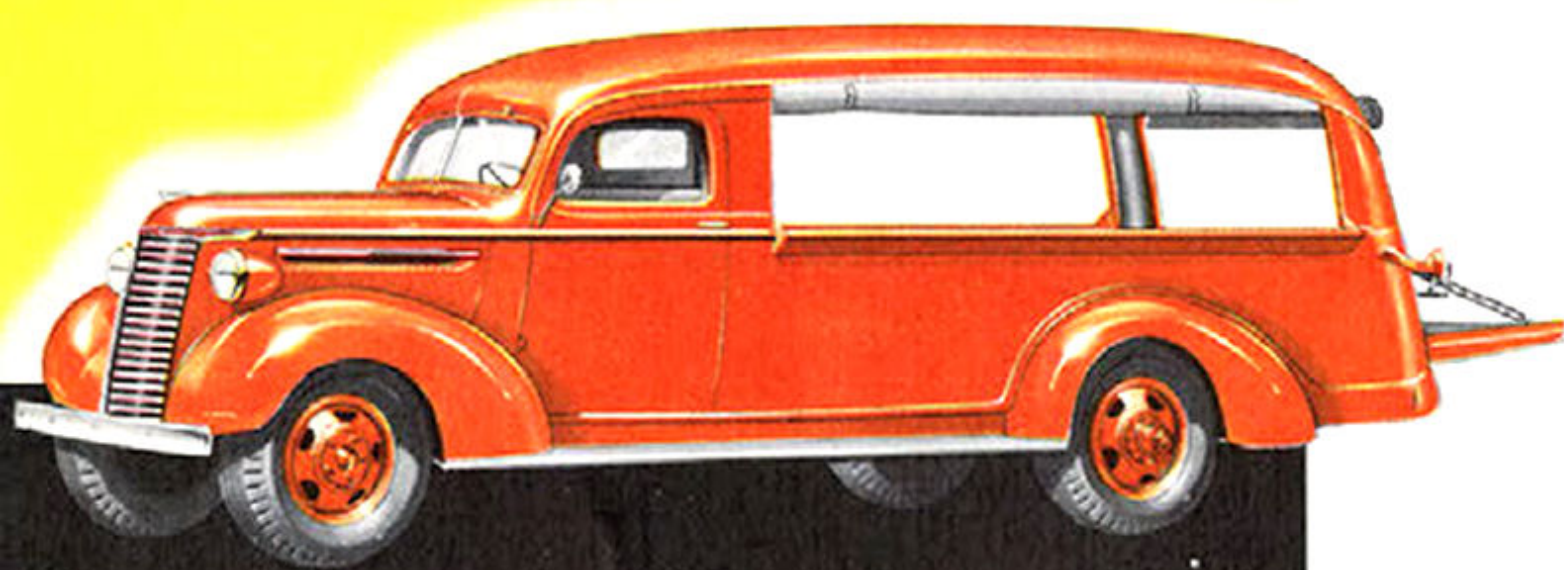

HEAVY DUTY CANOPY EXPRESS—Fine appearance combined with rugged construction for money-making load capacity . . . Roll curtains to protect load in bad weather . . . Screen sides furnished at small additional cost . . . Wheelbase, 133 inches.



LIGHT DELIVERY CARRY-ALL SUBURBAN—Ideal for use as passenger vehicle or for transporting varied loads . . . Easily converted by removing quick-fastening seats . . . Shock absorbers and deeply upholstered seats for full comfort . . . Vertical opening rear doors or tail gate and lift . . . Wheelbase, 113½ inches.

LL

AND CARRY ALL SUBURBAN

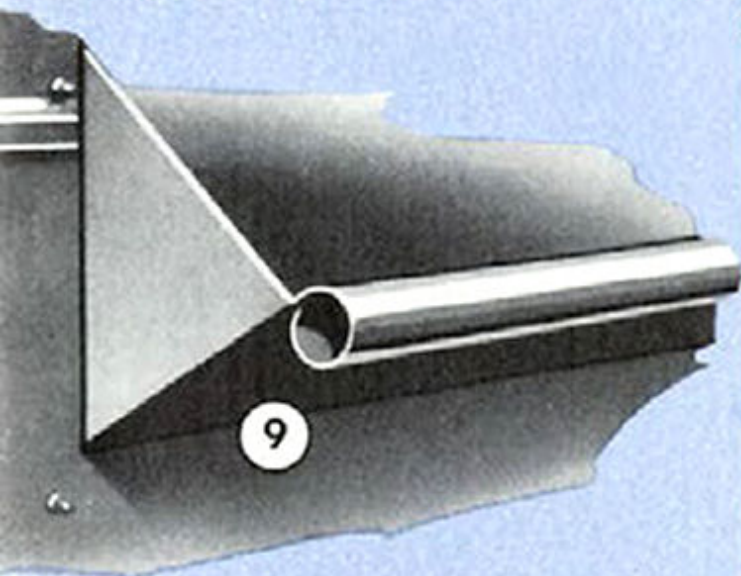

1 All-Steel Body Construction
—Steel sides and tops, strongly braced. Wood used in floor, for silence and long life.

2 Roof—The steel top is seamless. A drip moulding runs full length of the body.

3 Side Panels—Securely joined by riveting and welding. The compact wheel housing provides for maximum loading space.

4 Floor—Skid strips protect the load compartment floor.

5 Rear Pillars—Built of heavy structural parts, and flared to provide close fit for tail-gate.

6 Slam-Type End-Gate—All steel, heavily reinforced; latches automatically.

7 Waterproof Curtains—Side and rear curtains of oiled duck.

8 Screen Sides—Heavy wire protective closures are obtainable at a slight added cost.

9 Flare-Boards—Edges are rolled to add stiffness and durability.

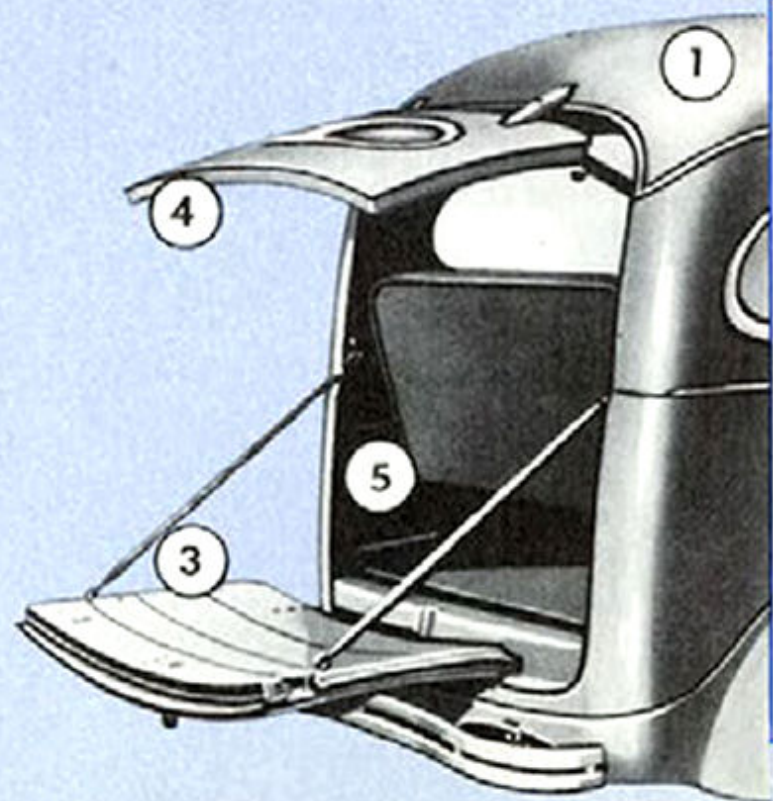
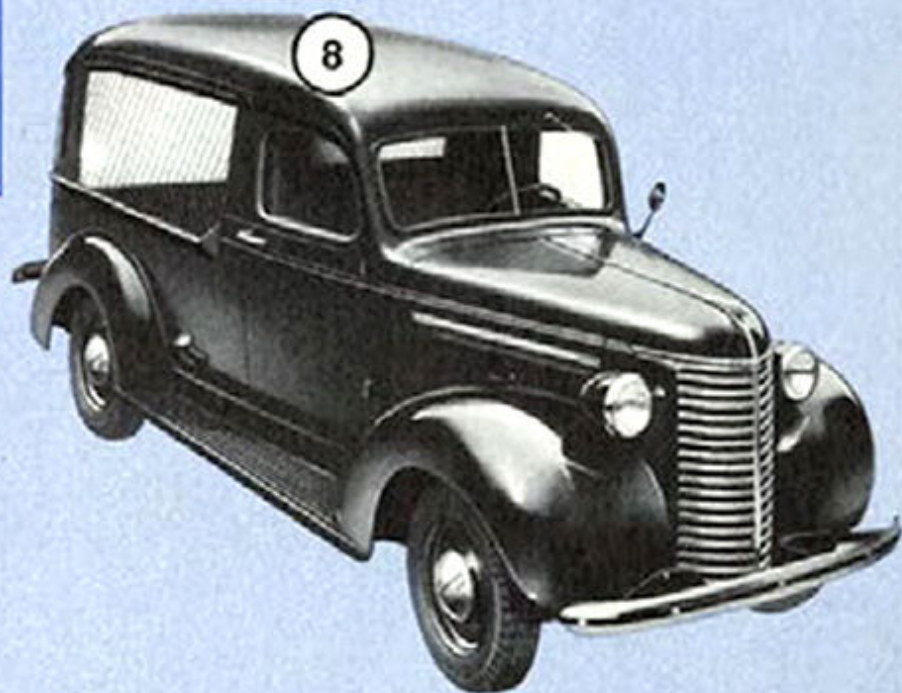
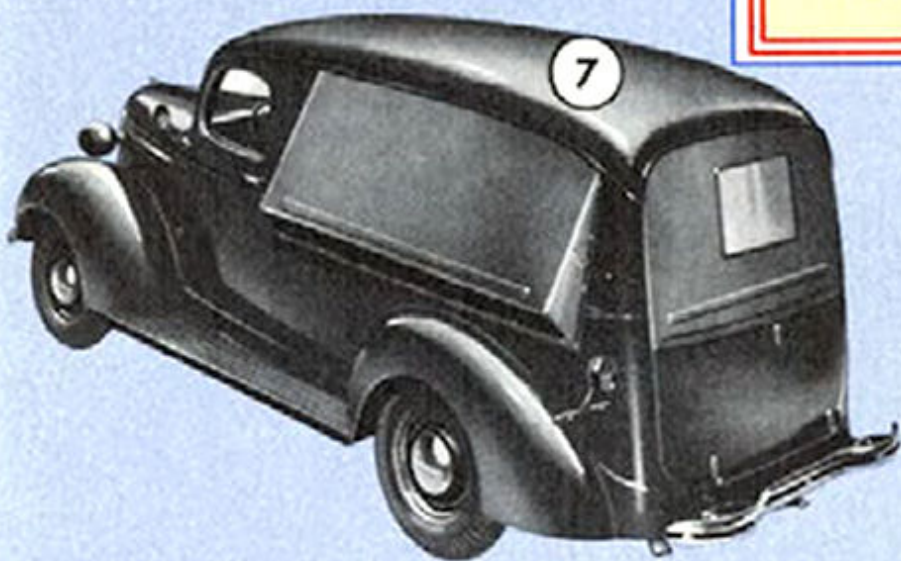
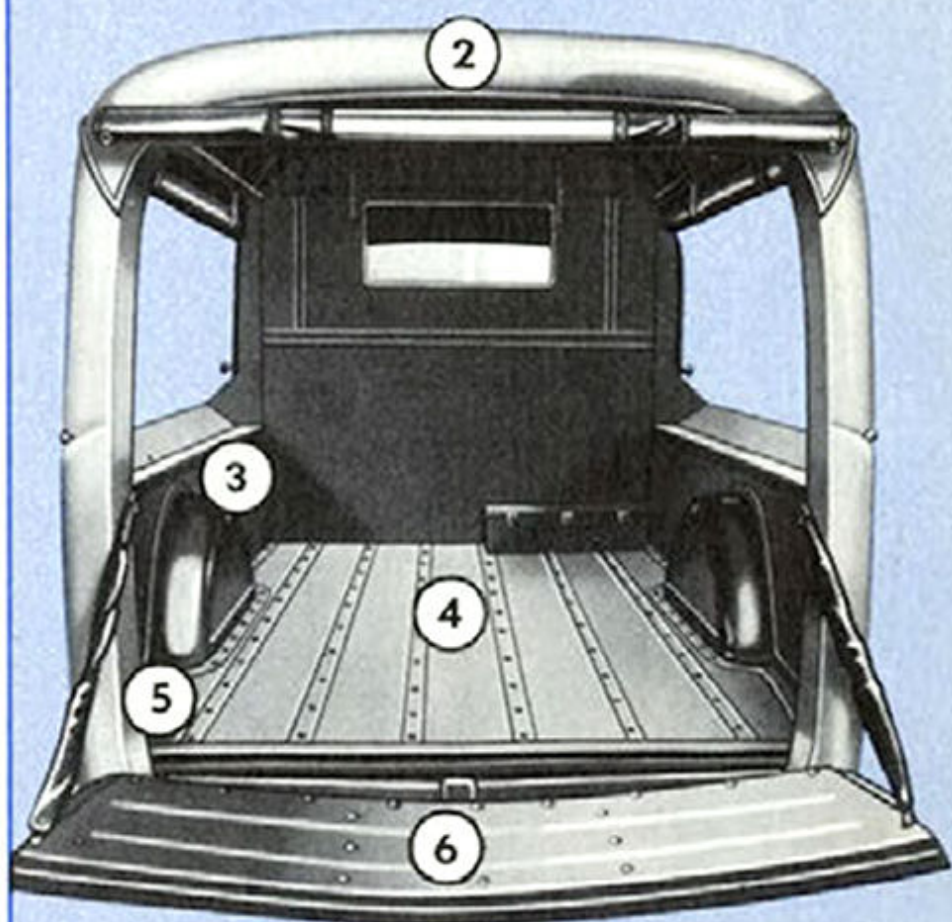

1 Body—Steel panels and forms, joined by welding.

2 Interior—Top and side walls are painted in an attractive finish.

3 Tail-Gate—Tail-gate and lift standard equipment; doors optional (no extra cost).

5 Convertibility—Quick-release hold-downs permit seats to be removed.

6 Windows—Safety-glass; may be lowered by crank controls.

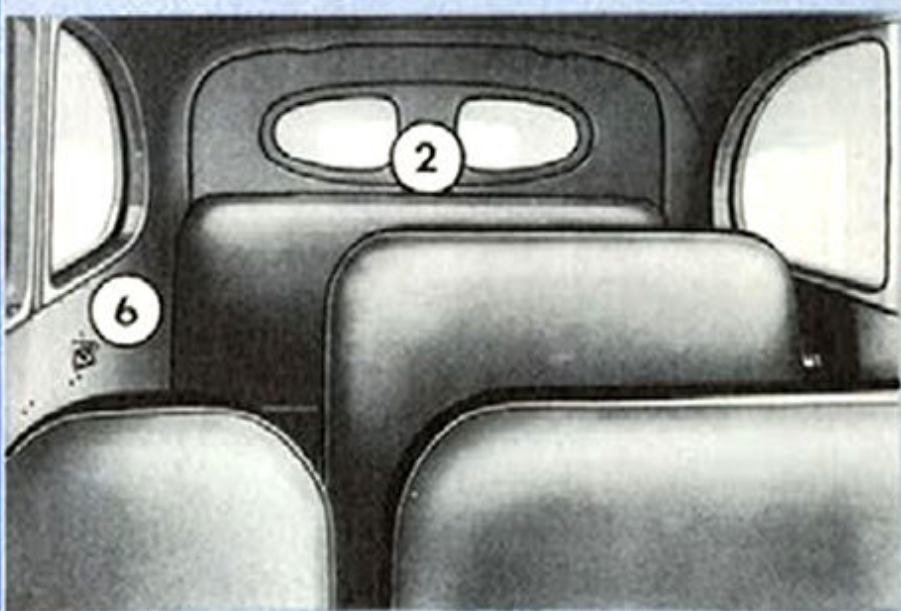

CHEVROLET PICKUP TRUCKS

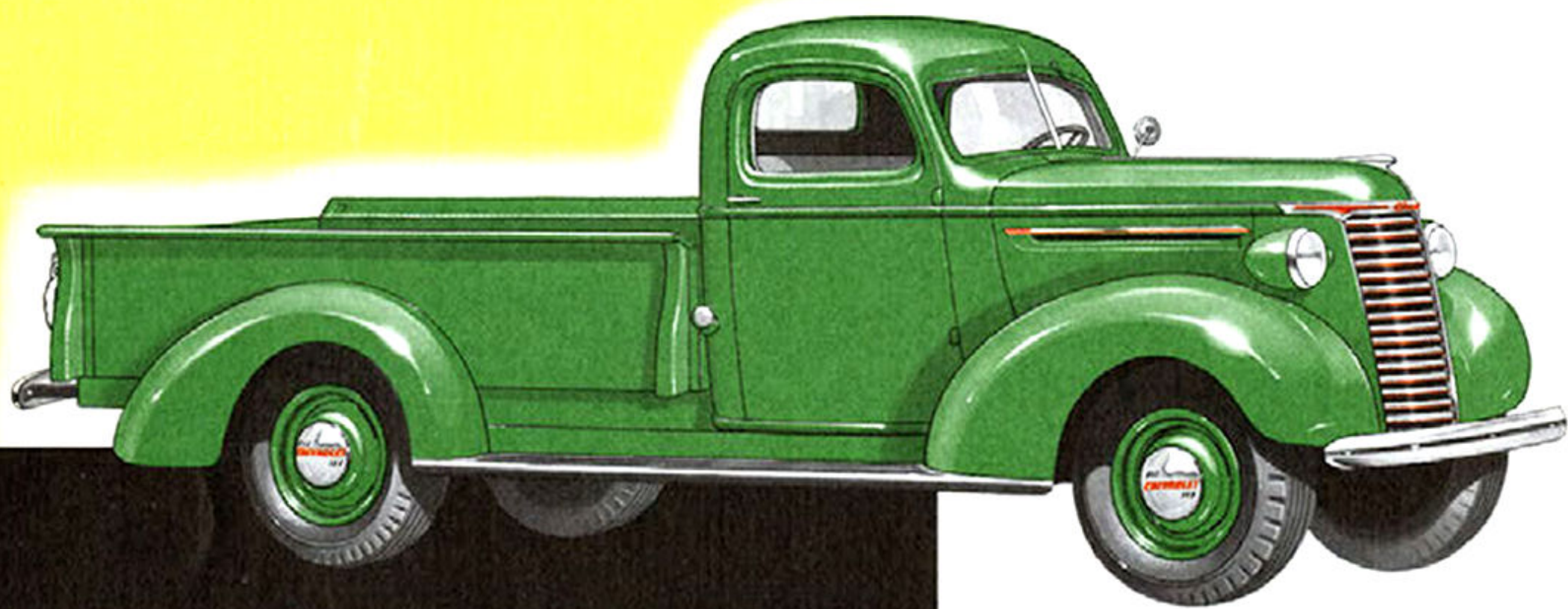

LIGHT DELIVERY PICK-UP—All-steel cab, fully streamlined . . . Easy loading body, all-steel construction . . . Wood floors . . . Metal treated to prevent rusting . . . Shock absorbers regular equipment . . . Speedy, economical and efficient vehicle for a wide variety of uses . . . Wheelbase, 113½ inches.

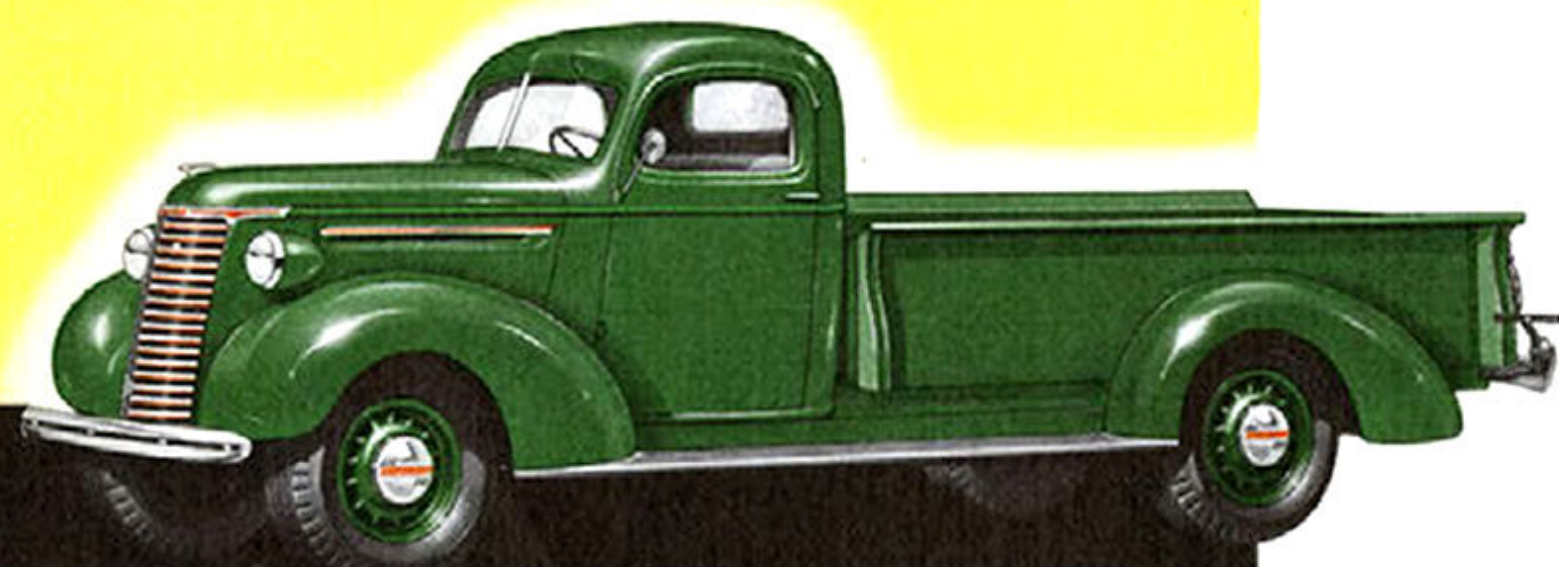

THREE-QUARTER-TON PICK-UP—Truck capacity with delivery car speed and economy . . . Unusually large load space . . . Streamlined all-steel cab . . . Wide flare boards, reinforced with rolled edges . . . Wheelbase, 123¾ inches.

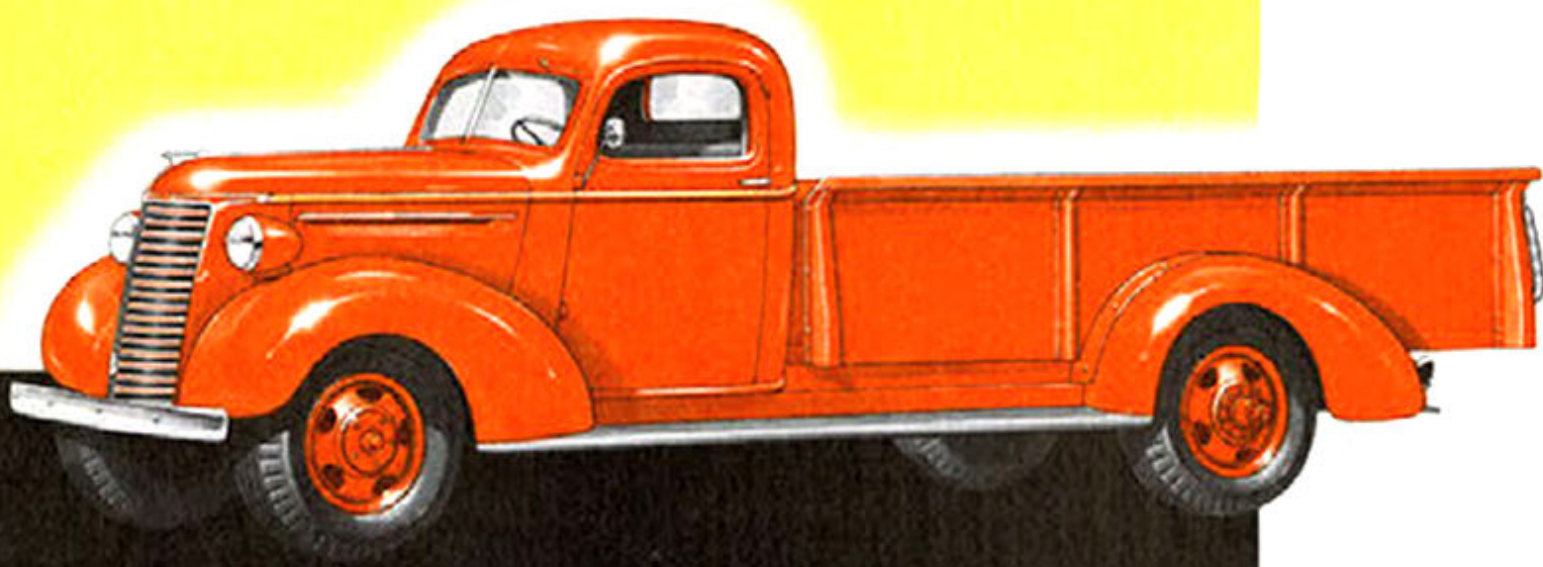

HEAVY DUTY PICK-UP—The large body makes it a vehicle of innumerable uses and wide application . . . Its all-steel cab brings handsome appearance to this strictly commercial vehicle . . . Capacity, 1½ tons . . . Wheelbase, 133 inches.

CHEVROLET PICKUP BODY FEATURES

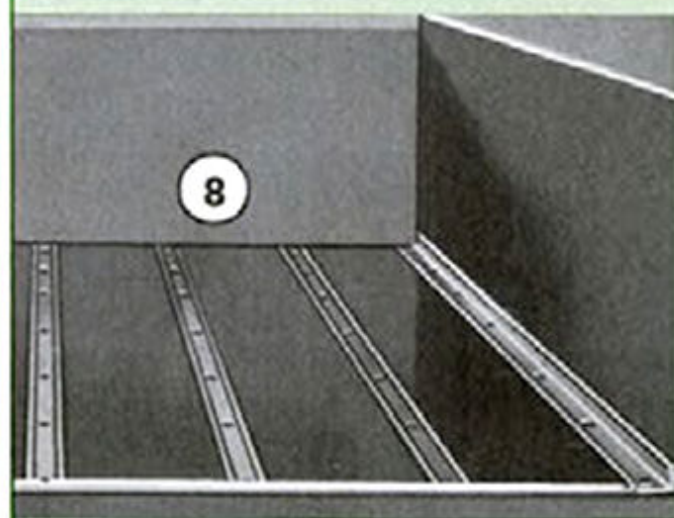
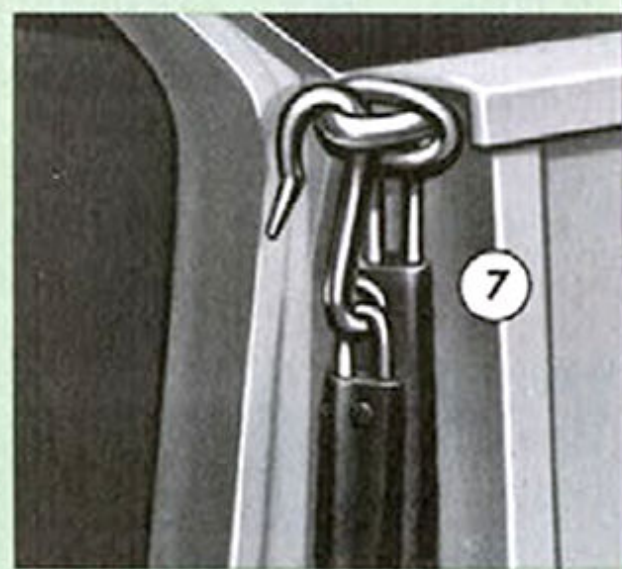
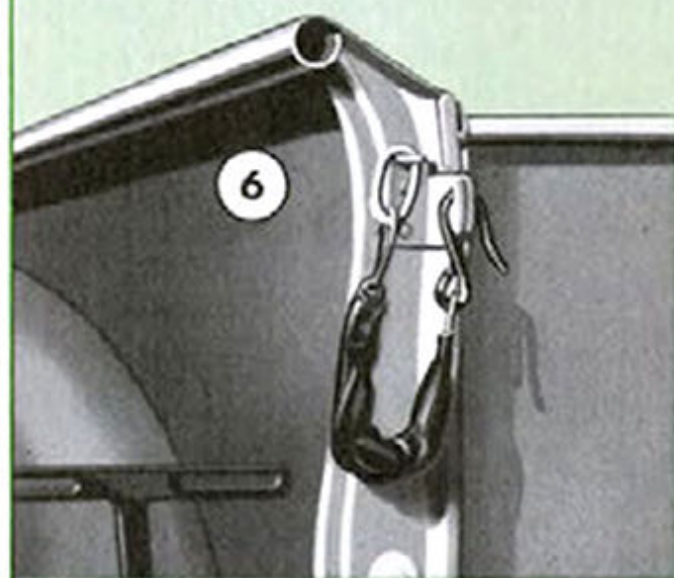
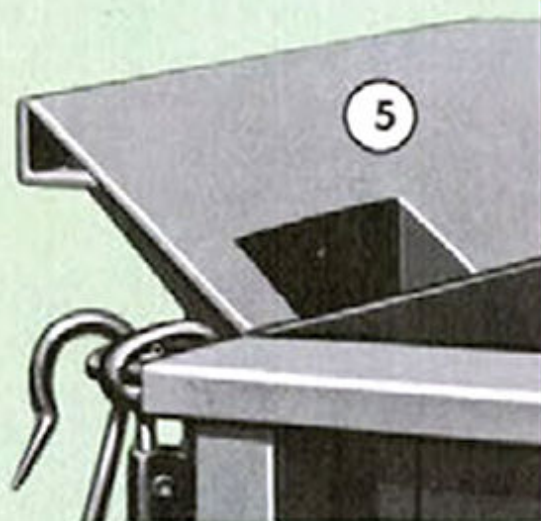
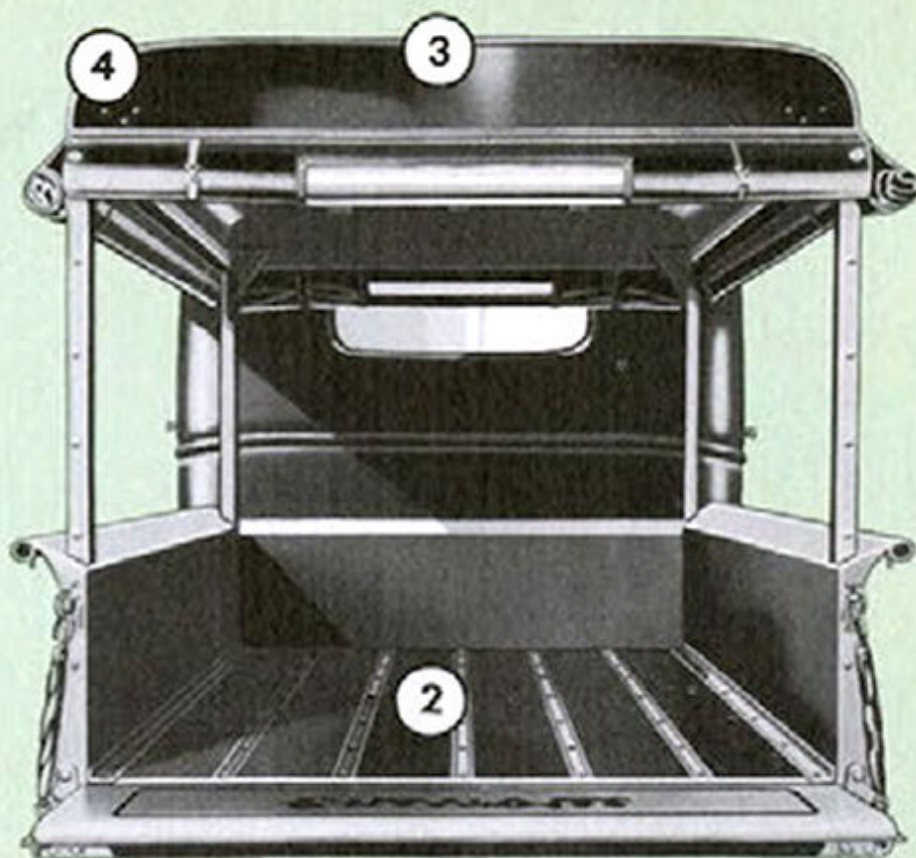
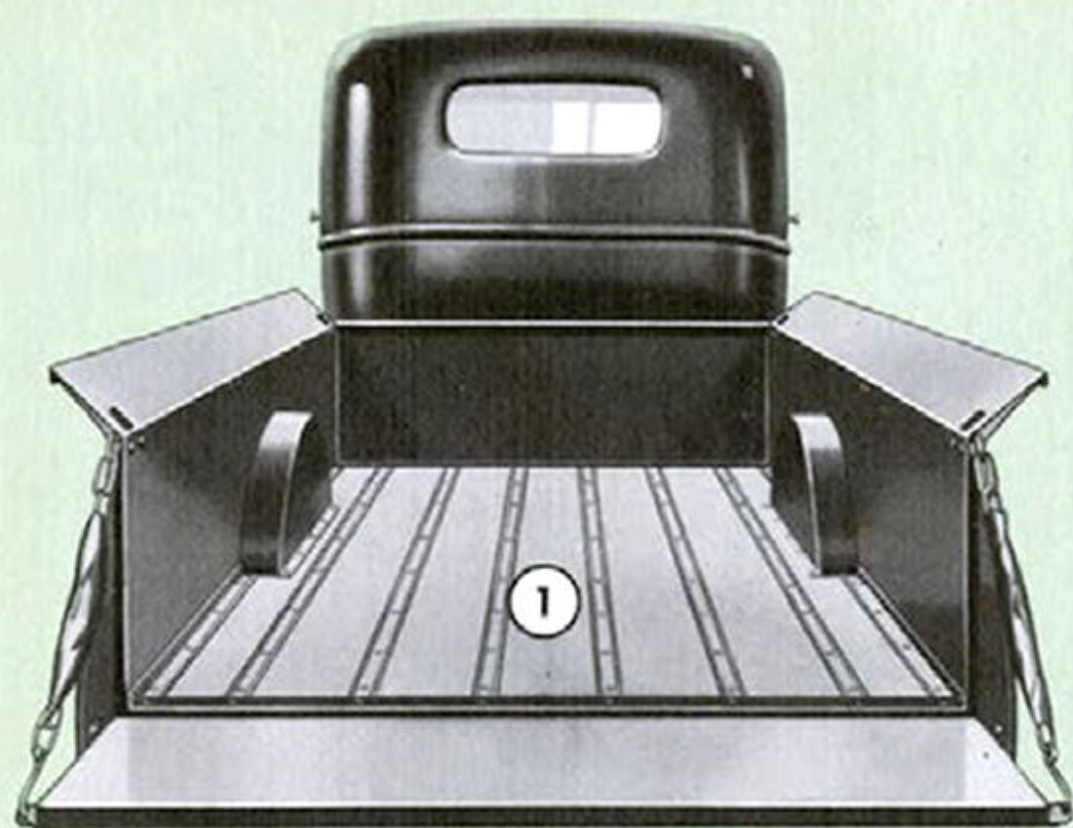

1 Large Load Capacity—Deep sides and shallow fender-wells provide ample space. (*Heavy Duty* illustrated.)

2 Loading Convenience—Unobstructed floors and right-angle sides make loading easy. (*Light Delivery* illustrated.)

3 Canopy Top—Durable, easily installed or removed. (Furnished only for *Light Delivery* at slight additional charge.)

4 Side and Rear Curtains—Weatherproof material; quickly raised or lowered. (Furnished with the canopy top on *Light Delivery* only.)

5 Flare-Boards (Heavy Duty)—Triangular section reinforcement means extra strength.

6 Flare-Boards (Light Delivery and ¼-Ton)—The edges are rolled for extra strength and to facilitate loading.

7 End-Gate Fastenings—All models have means of securing the tail-gate quickly and positively.

8 Floor—Skid-strips facilitate loading and add to durability.

9 Trim End-Gate (Light Delivery)—Tubular reinforced top, anti-rattle fastening.

10 End-Gate (Heavy Duty)—Sturdily reinforced with vertical and horizontal bracing.

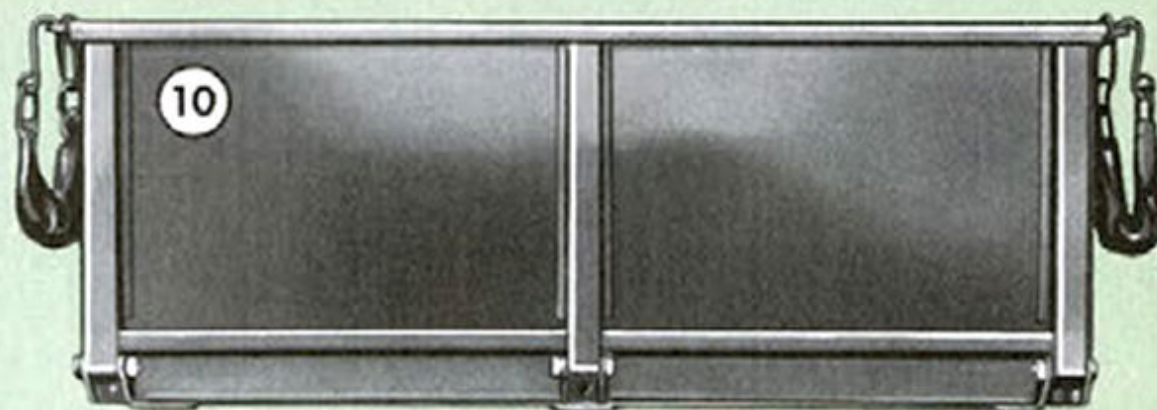

CHEVROLET STAKE TRUCKS

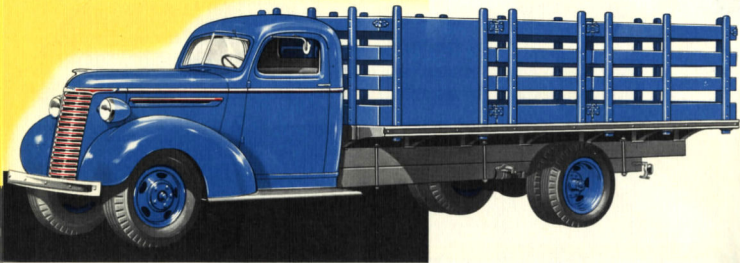

HEAVY-DUTY STAKE (158½" WHEELBASE)—Body specially adapted for heavy-duty work . . . Construction facilitates loading from sides as well as back . . . Stake sides supported in reinforced steel pockets guarded by a heavy rub-rail . . . Capacity, 1½ tons . . . Wheelbase, 158½ inches . . . Load space: 141½" long, 81½" wide, 38½" high.

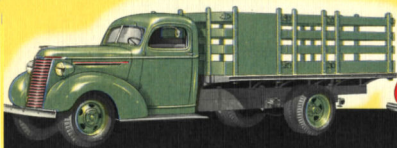

HEAVY-DUTY STAKE (133" WHEELBASE)—Possesses all the structural features and loading advantages of the 158½-inch model (see above) . . . Capacity, 1½ tons . . . Wheelbase, 133 inches . . . Load space: 105½" long, 81½" wide, 38½" high. One-Ton Stake (133" wheelbase) also available.



THREE-QUARTER-TON STAKE—A large loading platform . . . Stake sides supported in reinforced steel pockets, protected by a sturdy rub-rail . . . Wheelbase, 123½ inches . . . Load space: 87½" long, 71½" wide, 28½" high.

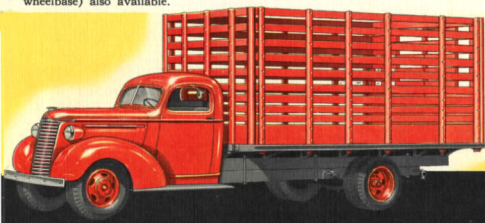

HEAVY-DUTY STOCK RACK—Floor and rack specially designed to prevent injury to stock . . . End-gate slides open (instead of swinging) for safety and to facilitate loading of stock . . . Capacity, 1½ tons . . . Wheelbase, 158½ inches. Load space: 141½" long, 81½" wide, 66½" high.



HEAVY-DUTY STAKE EXPRESS—Same body features as Stake . . . Tail-gate furnished at a slight added charge . . . Capacity, 1½ tons . . . Wheelbase, 158½ inches . . . Load space: 142½" long, 81½" wide, 38½" high.

CHEVROLET STAKE BODY FEATURES

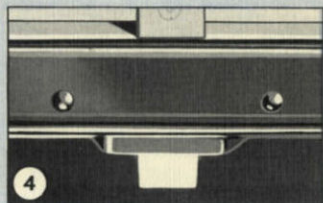
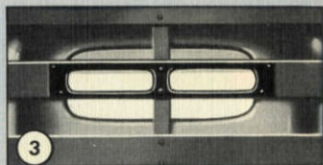
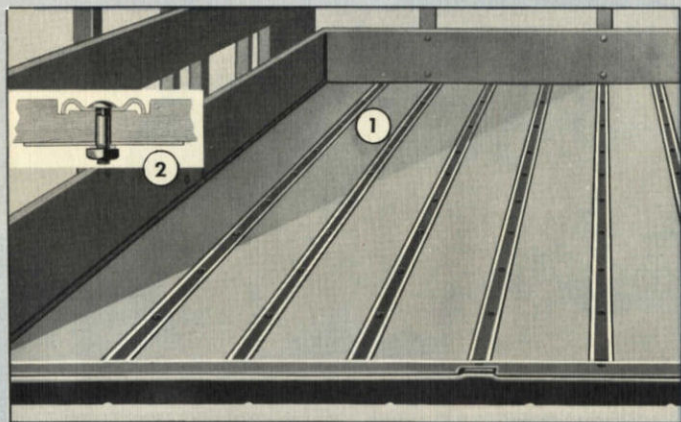

1 Platform Construction—Heavy floorboards are securely anchored by skid-strips.

2 Recessed Floor Bolts—Only the skid-strips project above the floor level.

3 Rear-Vision Plate (Stake Body)—Steel stamping through which the driver can see to the rear.

4 Stake Pockets—Stake pockets have strong braces. Steel rub-rail protects stakes and pockets.

5 Stock Rack Construction—Stake pockets are welded inside the rub-rail. Stakes fastened to slats with flush bolts.

6 Stock Rack End-Gate—The two sections slide to right and left.

7 Steel Cross-Sills—The platform is supported on rigid cross-members.

8 Swinging Side-Gates—Center sections of stake bodies may be swung open or easily removed.

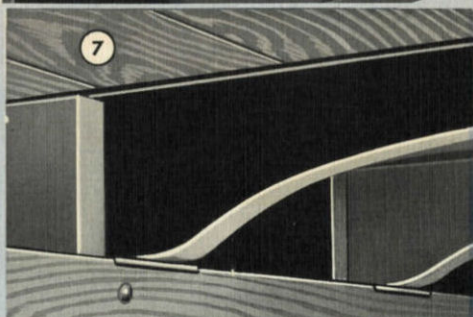
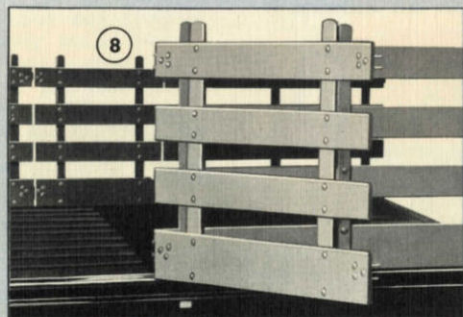
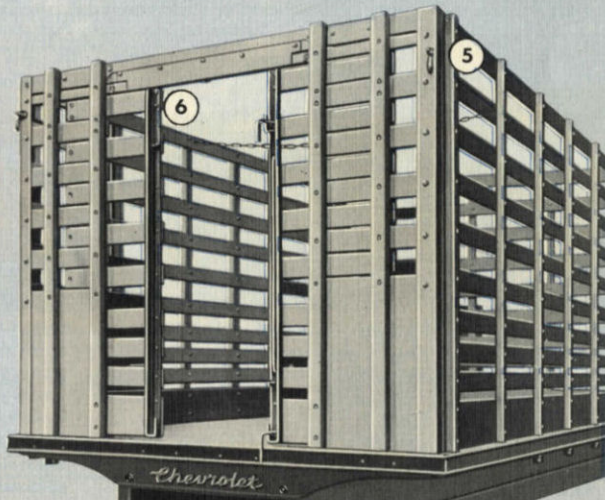

CHEVROLET TRUCK CHASSIS

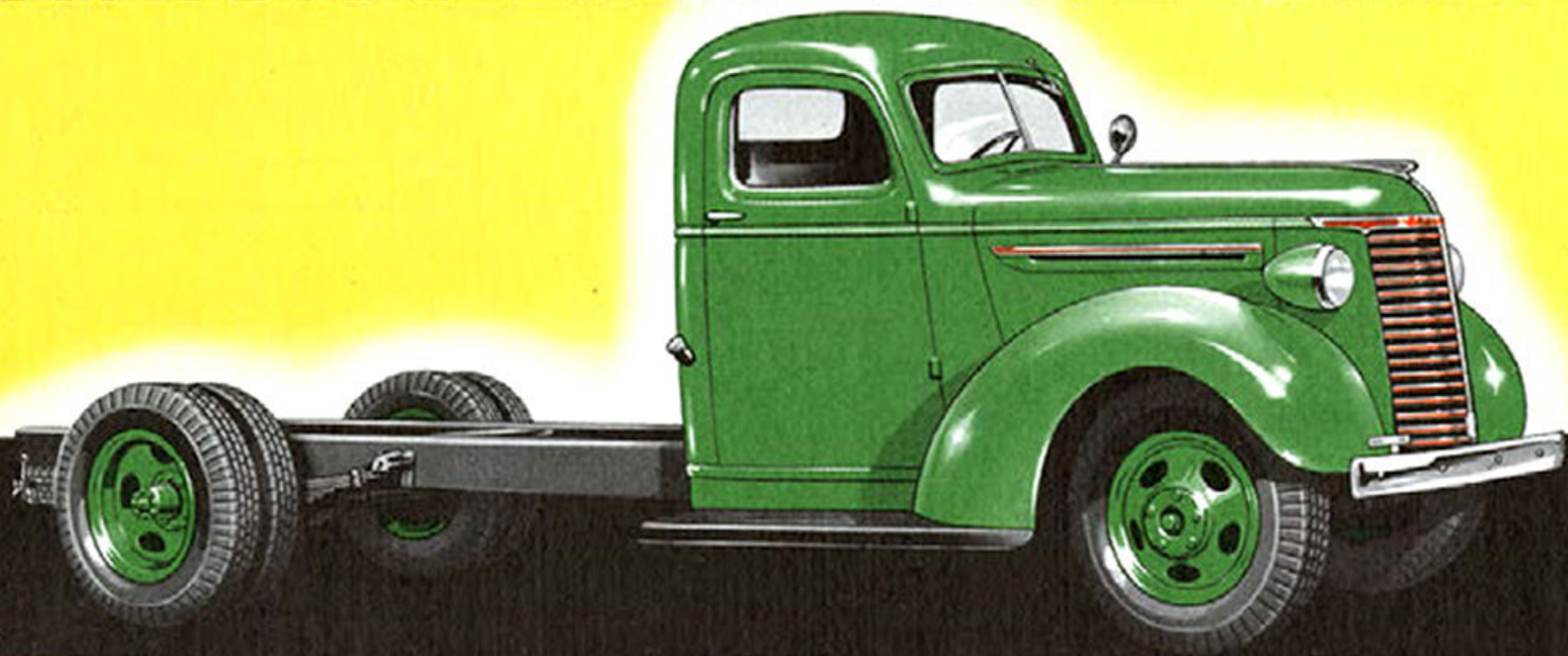

HEAVY DUTY 133" WHEELBASE CHASSIS AND CAB—Built to live up to its name, and to the world-wide reputation it has already established, the *Heavy-Duty* incorporates feature after feature that contributes to economy, durability, and performance.

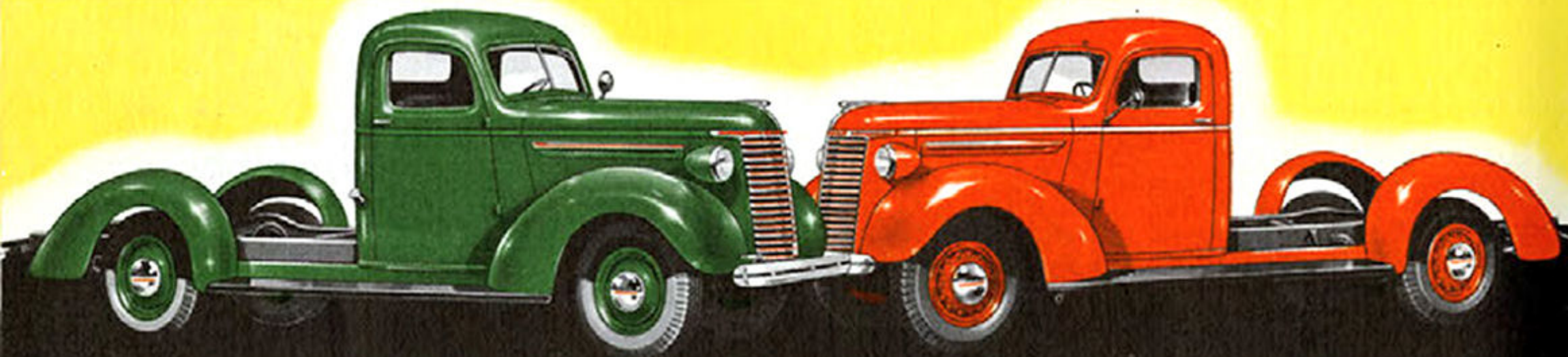

LIGHT DELIVERY CHASSIS AND CAB—113½" wheelbase. Combines the speed and easy-riding required for delivery work with the strength and sturdiness required for continuous operation.

THREE-QUARTER-TON CHASSIS AND CAB—123¾" wheelbase. Fills the needs of truck-users requiring a weight-capacity anywhere between those of the *Light Delivery* and the *Heavy Duty*. Long running boards and rear fenders are available at no extra cost.

HEAVY DUTY 158½" WHEELBASE CHASSIS AND CAB—Like the 133-inch model illustrated above, this chassis is typically Chevrolet in its design and performance.

FLAT FACE COWL—For special body installation, any Chevrolet truck chassis may be purchased with flat-face cowl or (at a small added charge) pillars and windshield.

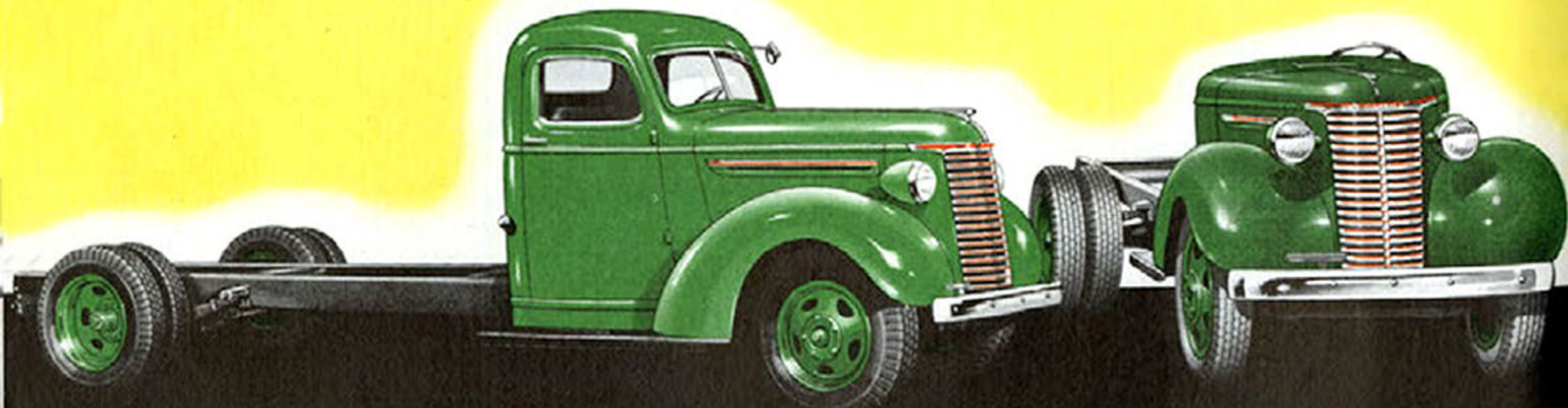

CHEVROLET CAB-OVER-ENGINE



Designed and built by Chevrolet. Special front-end (axle, bearings, springs, steering) and brakes. Wheelbase, 107 $\frac{3}{8}$ " or 131 $\frac{1}{8}$ ".



1 Large Roomy Cab—Chevrolet has succeeded in solving the problem of providing real roominess in a cab mounted over the engine.

2 Full-Width Seat—A single cushion, 18 $\frac{7}{8}$ inches wide, from door to door. Three men can ride without crowding.

4 Normal Gearshift—The gearshift lever is in the regular location rather than (as in some C-O-E trucks) at the rear of the cab.

5 Side Ventilators—Two ventilators in the sides of the cab provide for comfort.

6 Special Front Axle—Extra strength is built into the larger front axle. The steering drag-link runs forward to the front-mounted steering gear.

7 Special Front Springs—To support the added load, the front springs are of extra capacity.

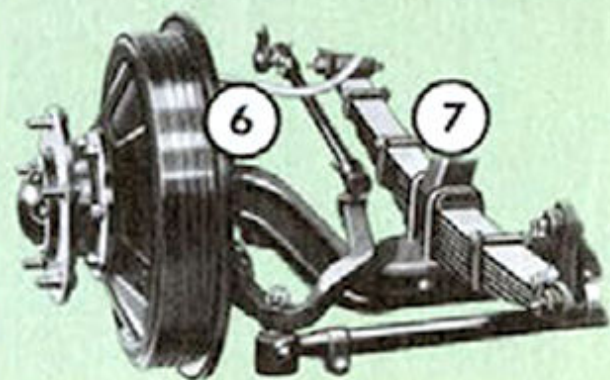

SCHOOL BUS CHASSIS

(193 $\frac{3}{8}$ " W.B.)—Designed specially for school bus purposes, with many special features to add to safety, flexibility and riding qualities (see specifications on page 20) . . . Powered by *Heavy Duty* truck engine . . . Hydraulic brakes with over-size brake drums.



SEDAN DELIVERY • COUPE

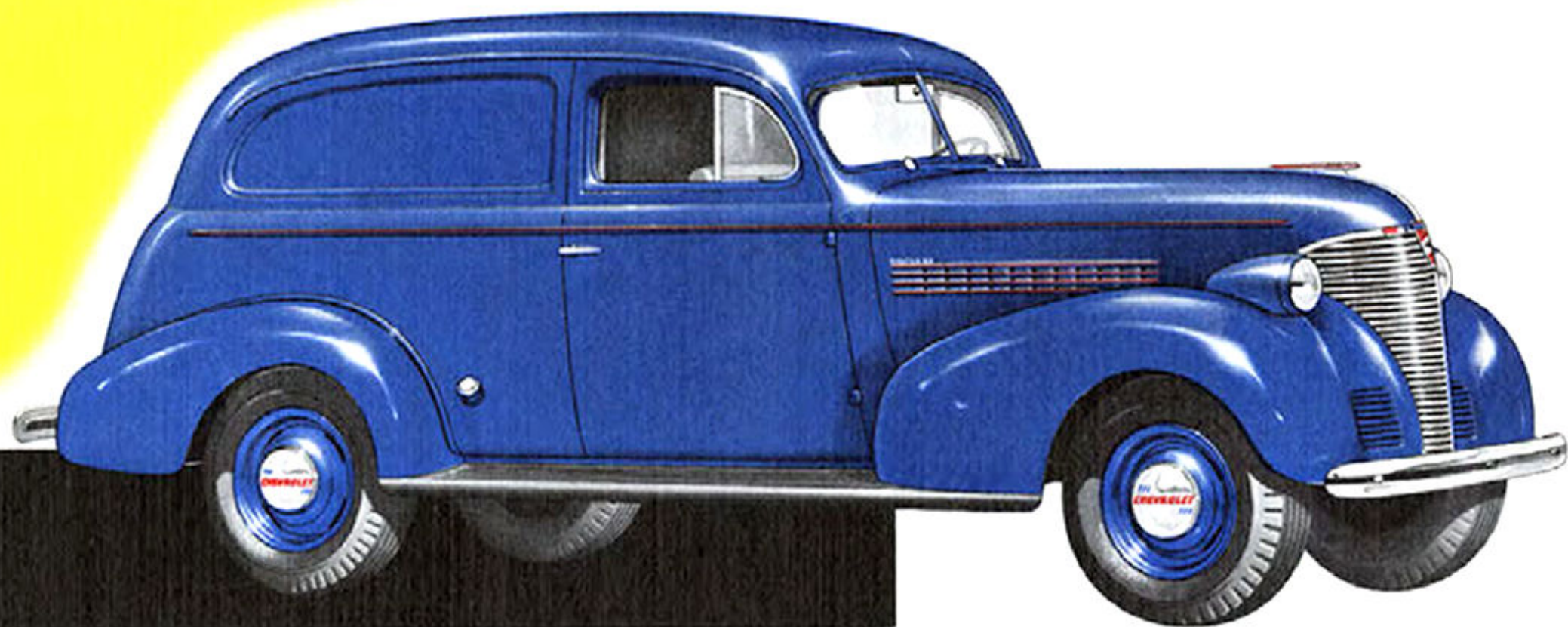

SEDAN DELIVERY—Special all-steel body mounted on the 1939 *Master 85* passenger car chassis . . . Particularly recommended for easy riding, economy and speedy delivery . . . Hydraulic shock absorbers front and rear . . . Wheelbase, 112 $\frac{1}{4}$ inches.

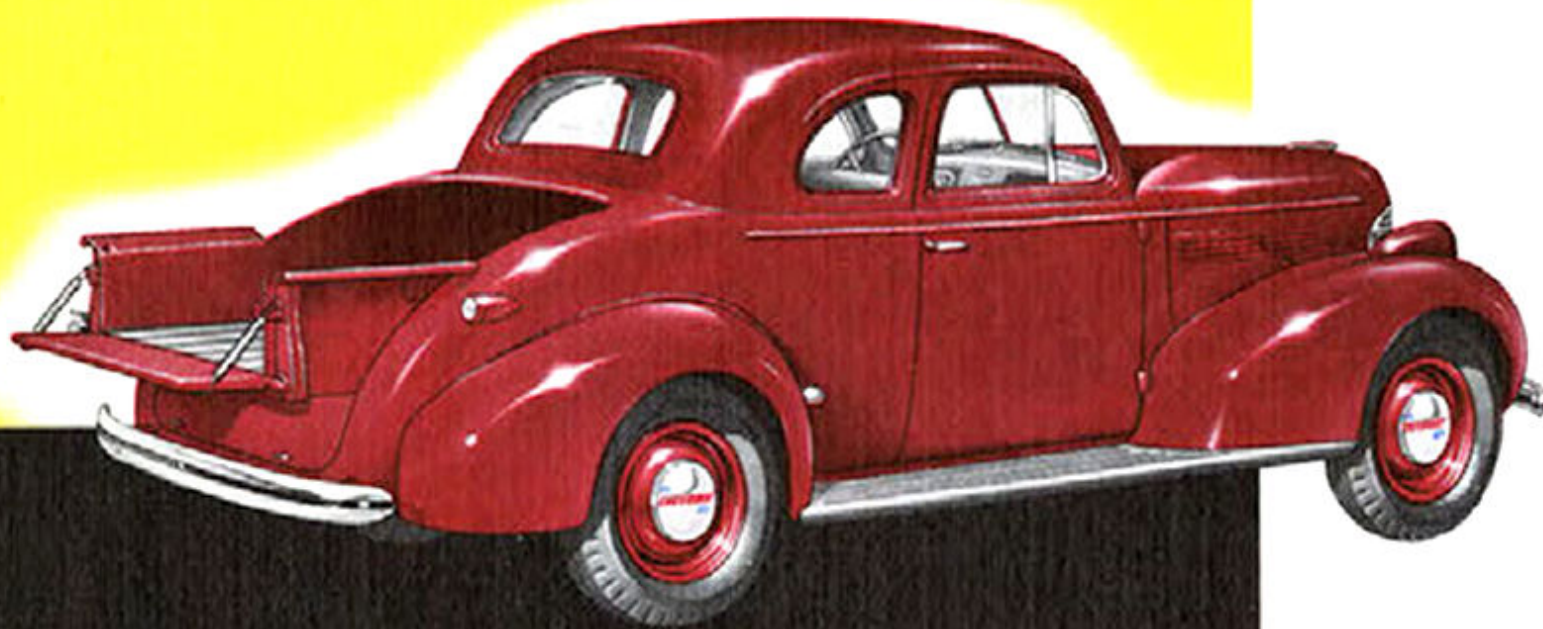

COUPE PICK-UP—Body and driver's compartment are similar to that of the *Master 85 Business Coupe* with pick-up box added . . . A rear deck lid is furnished for converting vehicle into a coupe . . . Wheelbase, 112 $\frac{1}{4}$ inches.

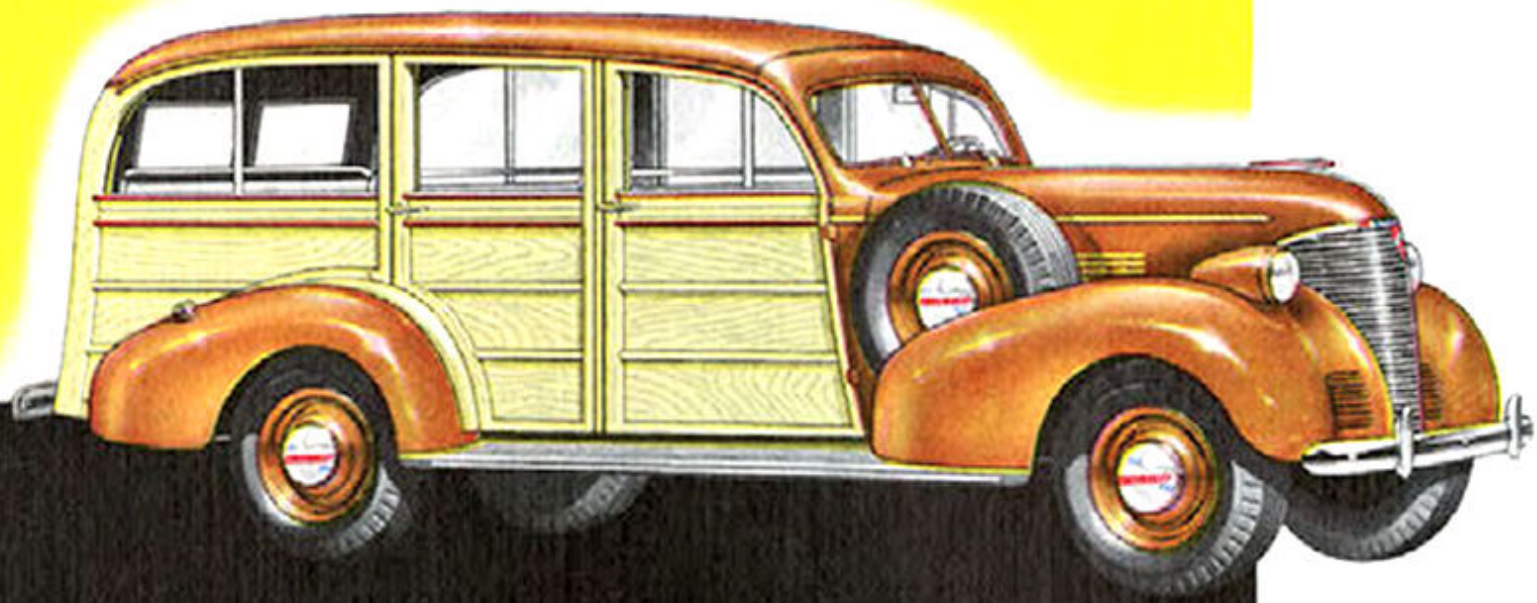

STATION WAGON—Furnished on *Master De Luxe* (Knee-Action as illustrated) or *Master 85* chassis . . . Capacity, 8 passengers . . . Removable seats . . . Paneled in natural finish birch plywood . . . Brown composition leather top . . . Wheelbase, 112 $\frac{1}{4}$ inches.

PICKUP AND BODY FEATURES

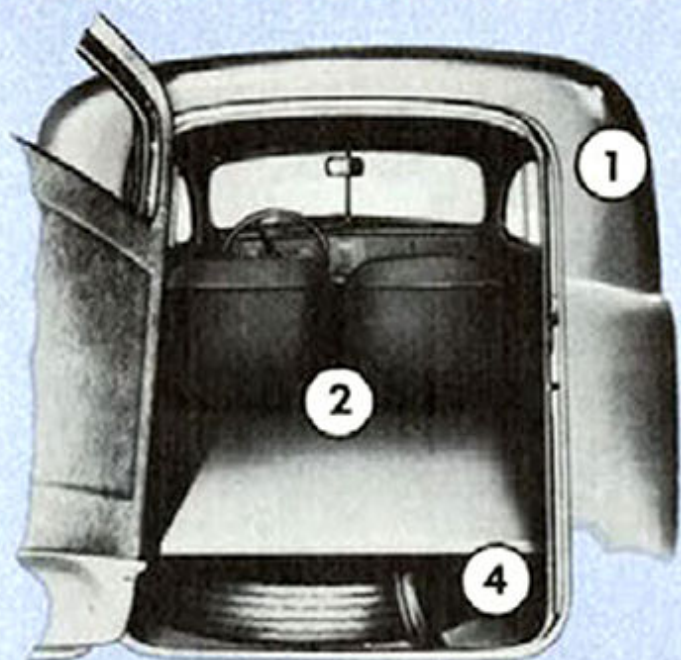

1 Unisteel Body—The main floor, cowl, panels and roof of the Sedan Delivery are welded together to form an all-silent, all-steel body.

2 Load Compartment—The Sedan Delivery load space is 77 cubic feet.

3 Pick-Up Capacity—The box is 66 $\frac{1}{4}$ " by 38 $\frac{3}{4}$ "; sides, 12" high.

4 Spare Wheel—Carried under the load platform, easily accessible.

5 Turret Top—The roof is a single steel stamping, reinforced and insulated.

6 Driver's Compartment—Sedan Delivery compartment trimmed in gray pyroxylin-coated moleskin fabric. Adjustable driver's seat.

7 Instrument Panel—The indicator dials are directly before the driver.

8 No Draft Ventilation—Air circulation is under complete control.

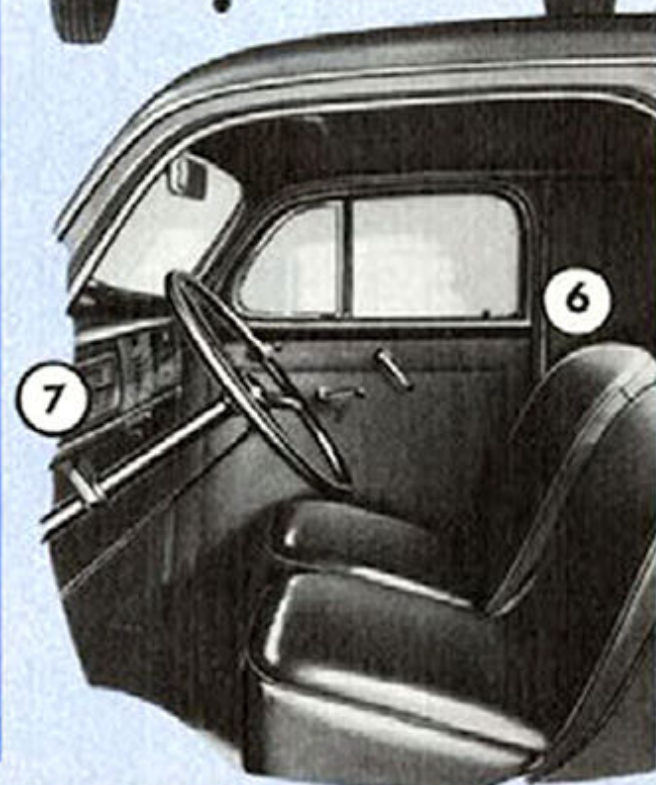
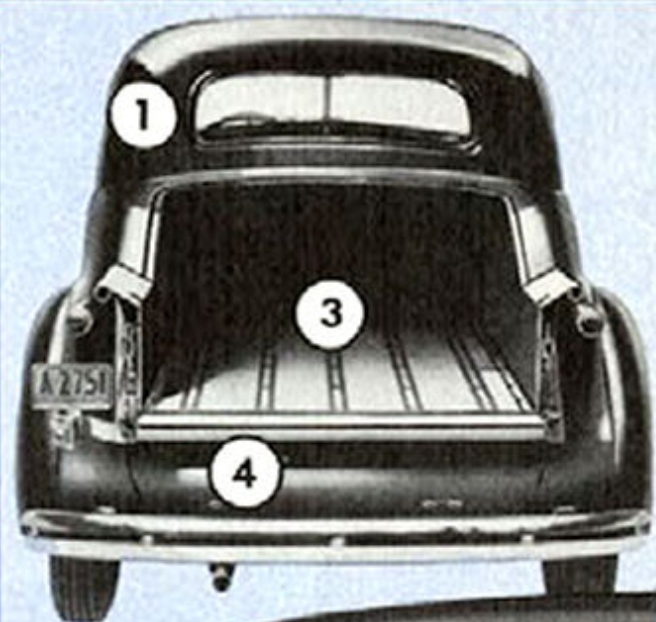

STATION WAGON FEATURES

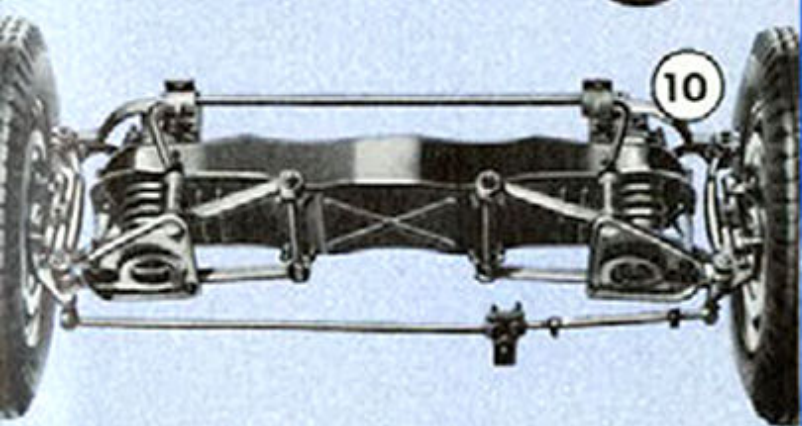
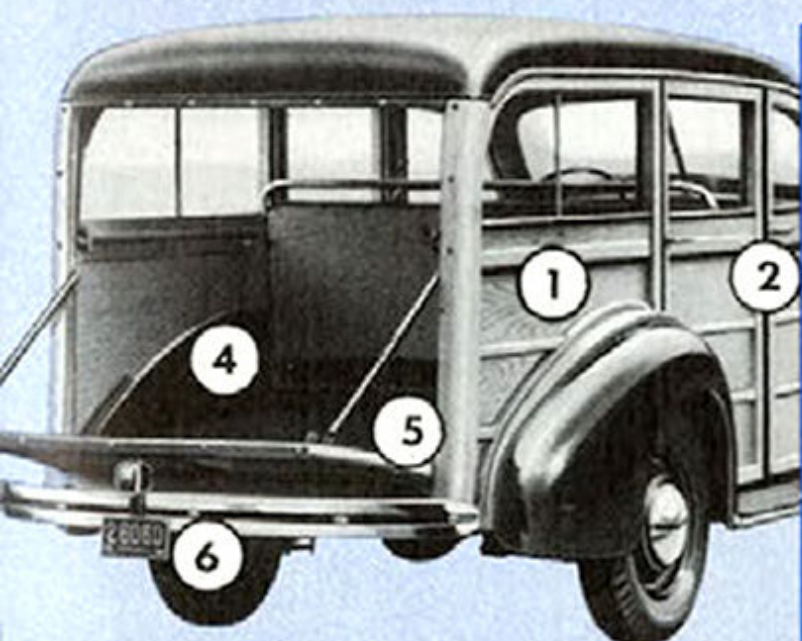

1 Body—Ash frame, birch plywood panels, brown composition leather top.

2 Four Doors—Hinged at the front.

3 Seats—Seat frames of metal tubing, enamel finish.

4 Removable Seats—The body can be quickly converted for hauling dead loads.

5 Heavy Tail Gate—Strongly built, to serve as a load carrier.

6 Safety Tail Lamp—When the tail gate is lowered, the lamp still faces the rear.

7 Spare Tire—Mounted in fender-well, right side, with tire cover and lock.

8 Interior—Smooth finish, typical passenger-vehicle trim.

9 Rear Curtains—Snap fasteners, two large pyrolin windows. Optional, at slight extra cost, is an upper lift gate matching the tail gate.

10 Knee Action—Improved individual front wheel springing is used on the Master De Luxe model.

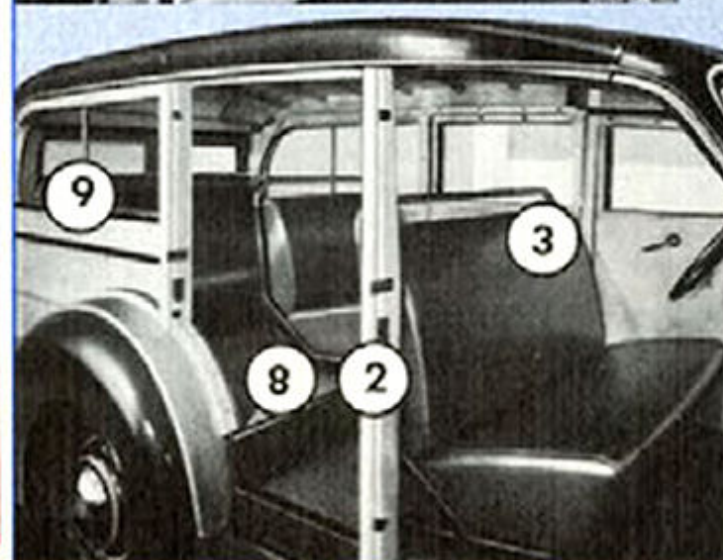
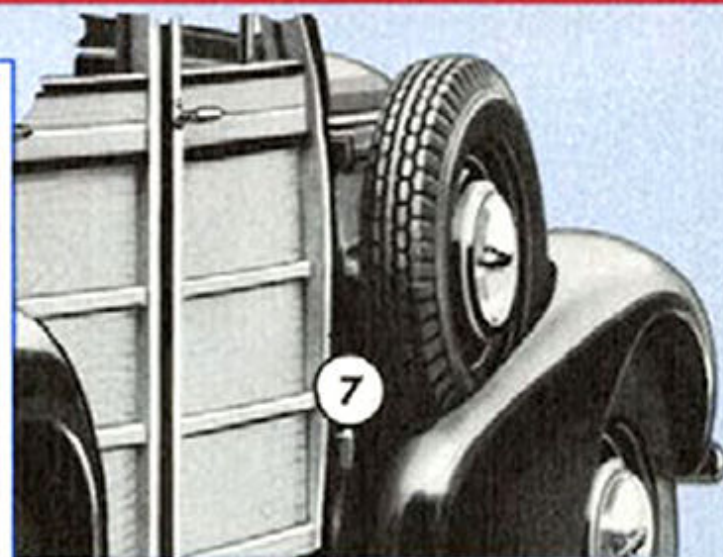

THE 1939 CHEVROLET

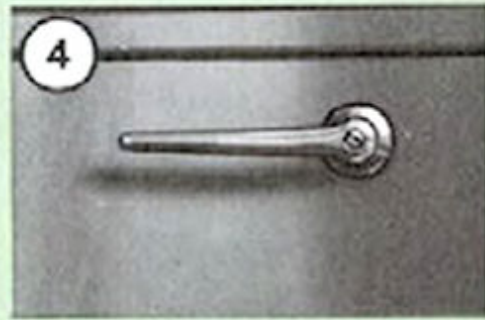
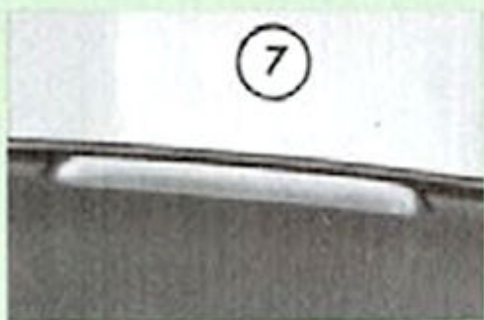
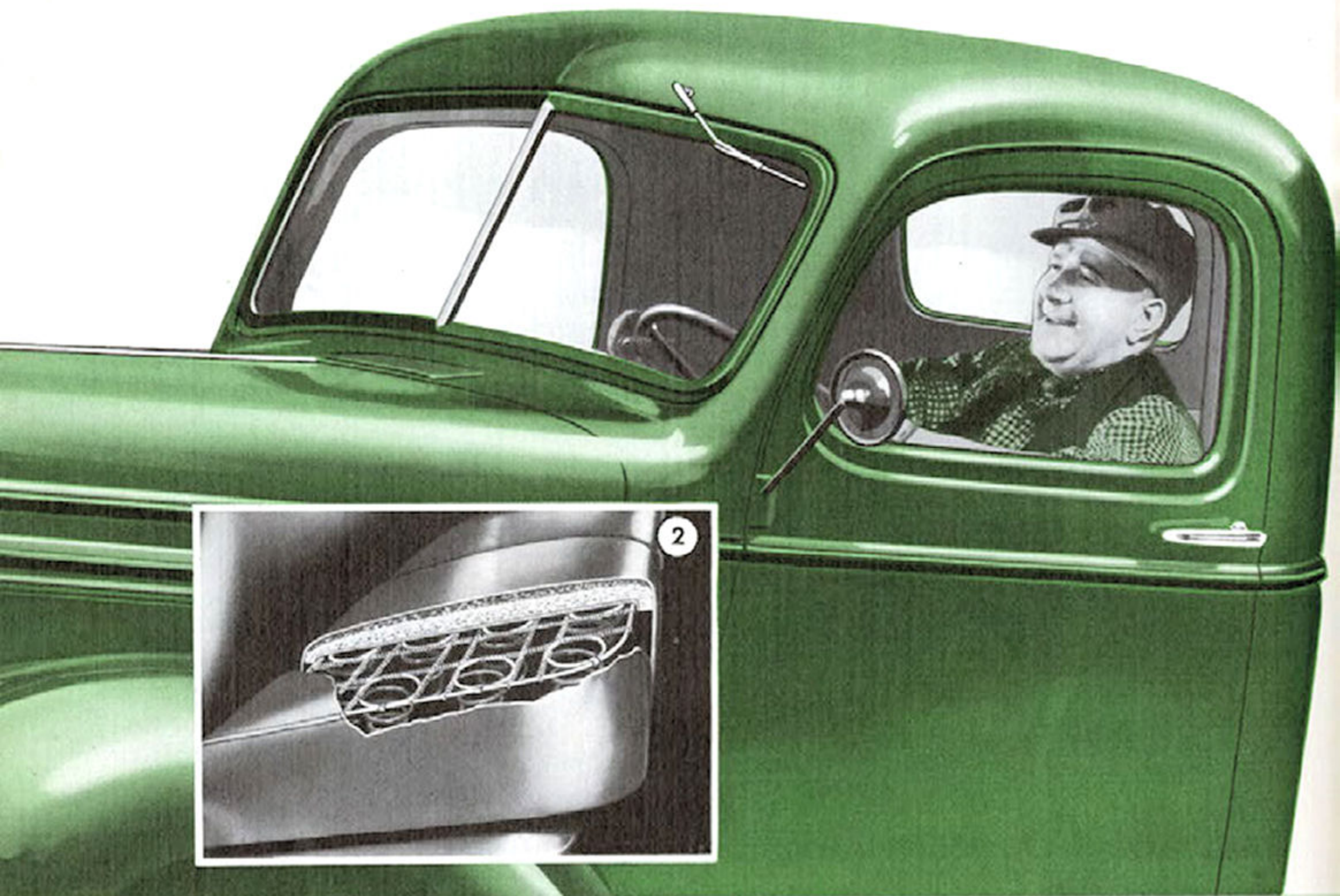

OBSERVED AND CERTIFIED BY THE AMERICAN AUTOMOBILE ASSOCIATION

**CHEVROLET TRUCKS HAVE
PROVED THEIR POWER,
ECONOMY AND DEPENDABILITY**



COAST-TO-COAST RUN—Chevrolet economy was demonstrated along a 3,511-mile route from Los Angeles to New York. Averaging 27.14 m.p.h., the *Heavy Duty* tractor unit, hauling a semi-trailer with a five-ton payload, established a record of 11.378 miles per gallon.

DELUXE TRUCK CAB

Chevrolet's All-Steel Cab, already noted for its outstanding advantages, has been improved for 1939 in many features. Note its unusual roominess, the accessibility of all controls, its smooth interior finish.

1 Driver's Seat—A single full-width cushion. Underneath the durable rubberized fabric upholstery is a latex-bound hair pad on resilient springs.

3 Doors—All-steel, hung on extra-heavy hinges. The inner steel panel has a pleasing finish. New hold-open door-checks.

4 Door Control—From the inside, the door is opened by a remote-control lever.

5 Windshield—Two large panels of safety-glass form the "V" windshield, which opens for ventilation.

6 Instrument Panel—The clear-vision indicators are directly before the driver. A crank regulator controls the windshield opening.

7 Defroster Slots—In trucks having heaters, blasts of warm air may be directed to keep the windshield free from clouding and frosting.

8 Package Compartment—A spacious compartment, with locking cover.

9 Gas-Tank Filler—Convenience and safety are served by its location outside the cab, on the right-hand side.

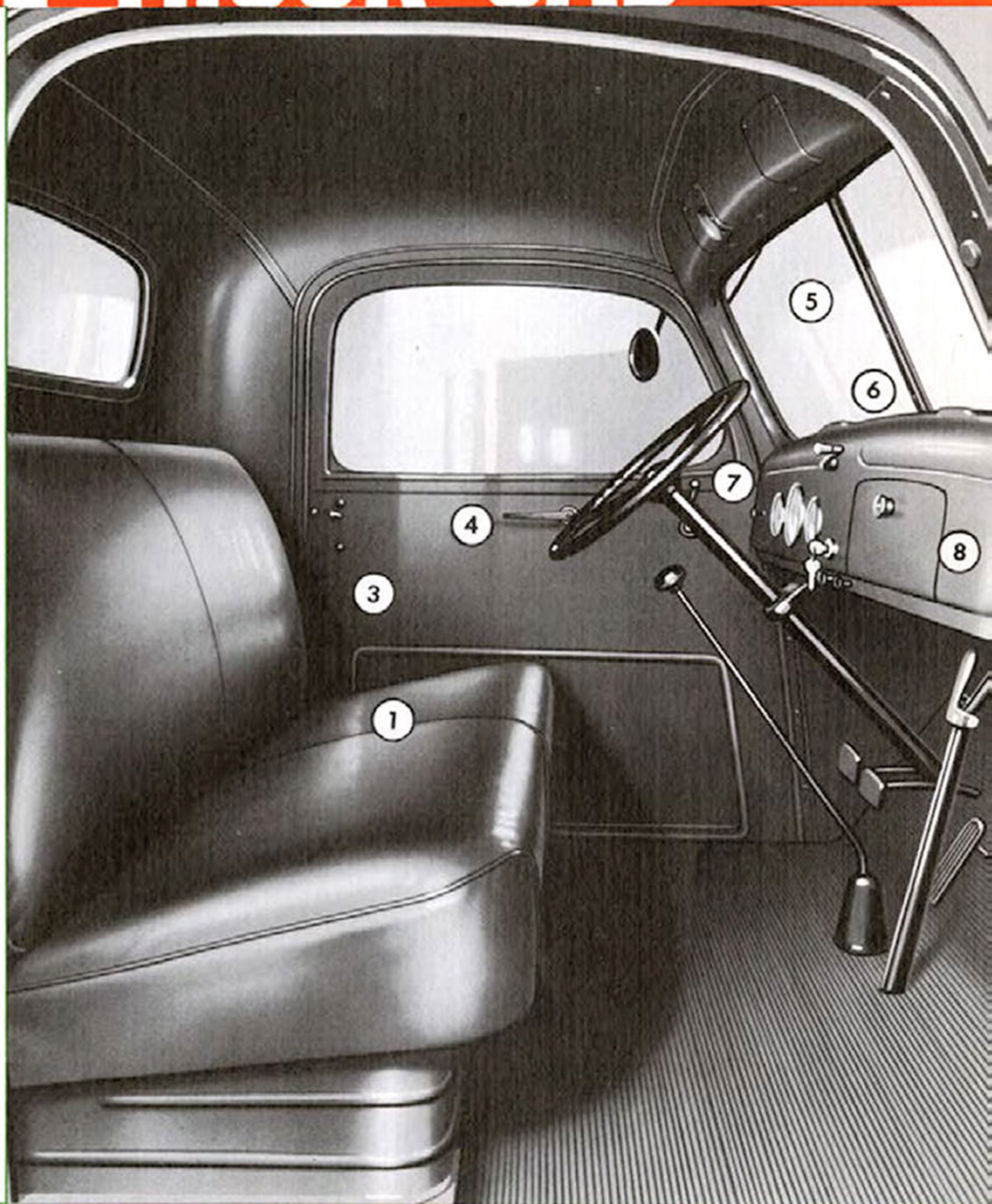

'ROUND-THE-NATION RUN—In a 10,244.8-mile trip around the rim of the United States, a Chevrolet *Economy Model* truck, carrying 1,060 pounds, established a remarkable record. Gasoline mileage averaged 20.74 to the gallon and cost was less than one cent a mile.

50,000-MILE ECONOMY AND DEPENDABILITY RUN—A Chevrolet *Heavy Duty* truck in constant operation (January 11-July 5, 1938) in Canada, Mexico and the United States, covered 53,825 miles under actual operating conditions, carrying a dead load of 4590 pounds (gross weight, 9260 pounds). Some of the figures, as certified by the A.A.A., are: Average m.p.h., 32.41. Miles per gallon, 15.37. Ton miles per gallon (gross weight), 71.16. Gasoline cost per mile, \$.01312; per ton-mile, \$.00283. Miles per quart of oil, 1320. Total cost mechanical work, \$32.99; total replacement costs (less tires), \$21.99.

5 BASIC REASONS WHY

CHEVROLET'S

VALVE IN-HEAD

FASTER INTAKE OF FUEL MIXTURE

VALVE-IN-HEAD ENGINE

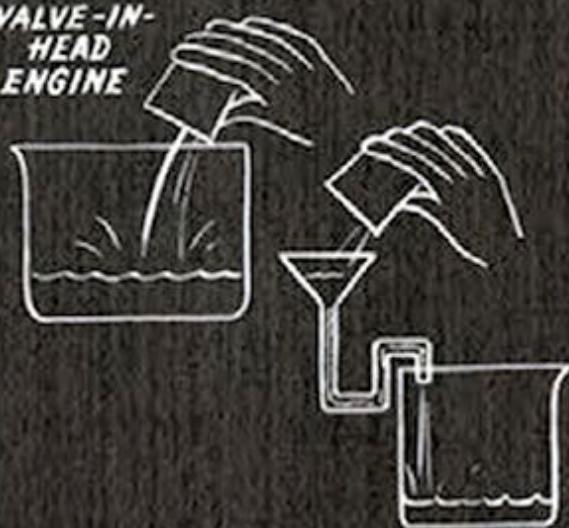

1 The power developed by any internal-combustion engine depends upon the flow of the fuel mixture into the cylinders. The valve-in-head principle makes possible a direct flow of the mixture from the manifold into the combustion chamber, as against the circuitous path in other types.

BETTER FUEL ECONOMY

VALVE-IN-HEAD ENGINE



2 In the valve-in-head type engine, the intake and exhaust valves can be advantageously located with relation to the spark plug and the piston, to effect improved combustion and cooling. Only the Chevrolet valve-in-head engine has combustion chambers scientifically shaped to cause blue-flame combustion—combustion under control that assures maximum economy.

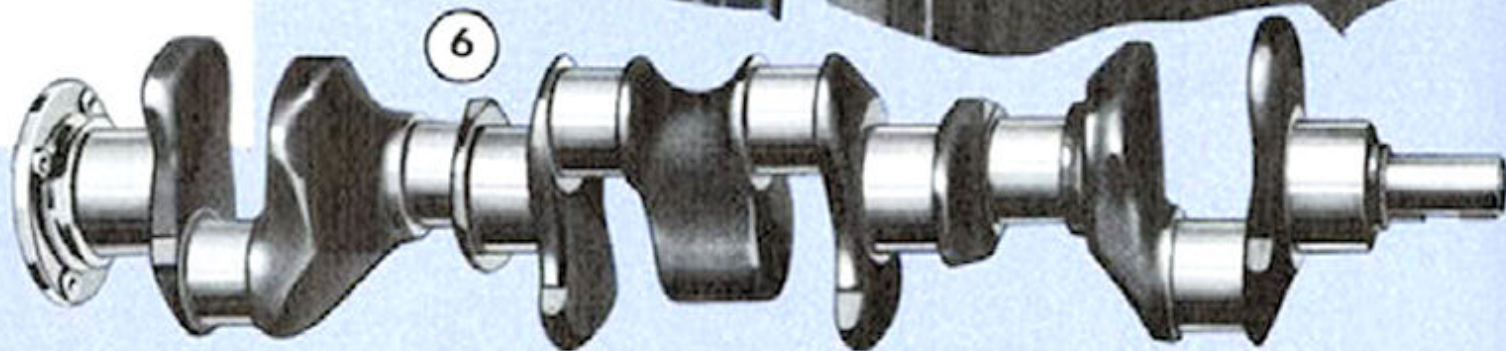
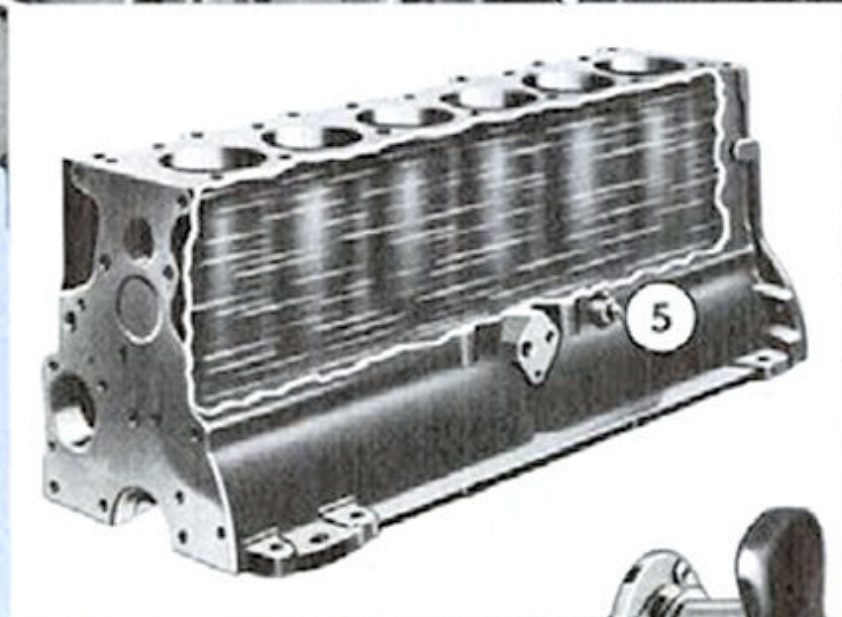
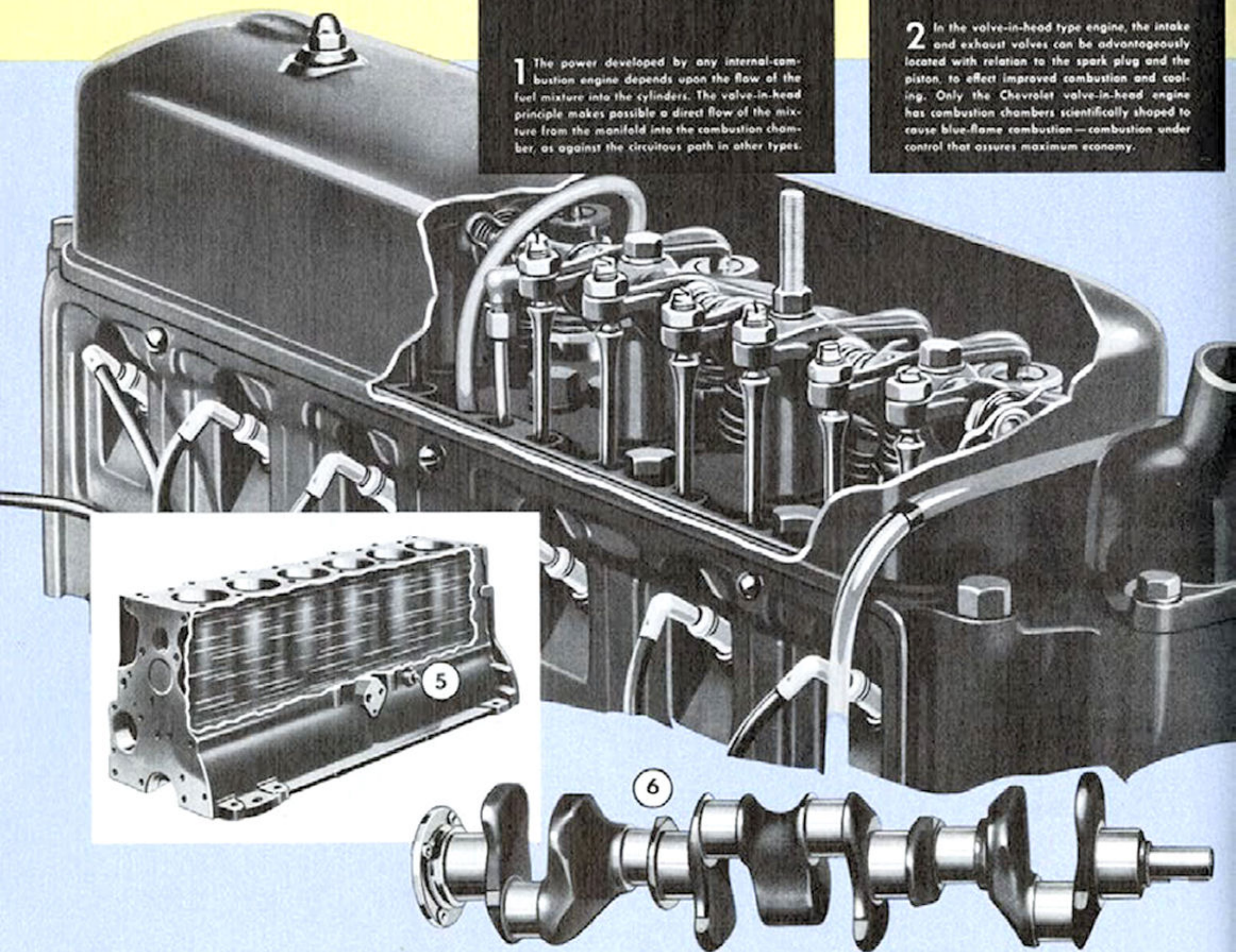

TRUCK ENGINE LEADS IN TRUCK OPERATION

QUICKER AND MORE COMPLETE EXHAUST OF BURNED GASES



3 Just as the direct flow of mixture into the cylinders results in greater power output, so does the location of the exhaust valves in the cylinder head mean a gain of power, because the piston meets with less resistance in forcing the exhaust gases out of the cylinder. In other words, the valve-in-head principle brings about a decrease in back pressure as the pistons rise on the exhaust stroke.

LESS HEAD AREA TO ABSORB HEAT DURING POWER STROKE

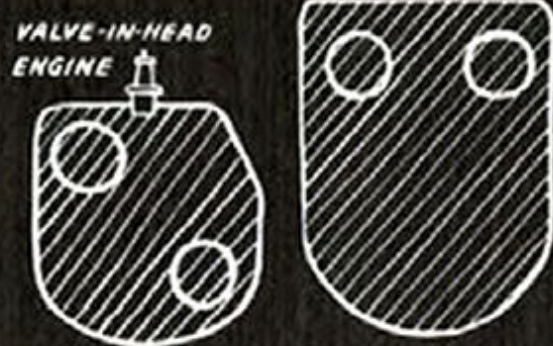

4 The more heat that is produced within an engine cylinder by the explosion of the fuel mixture, the more is the power available to drive the pistons. Efficiency in an engine consists in gaining the highest possible advantage from the heat of combustion; naturally, loss of heat is the same as loss of power. The Chevrolet valve-in-head engine conserves the heat of combustion because the area of the combustion chamber is small, as compared with engines having the valves located beside the cylinders instead of directly over them. Because there is less area exposed to the heat of the fuel mixture, less heat is carried away through the metal, and wasted.

CONTROLLED EXPANSION OF CYLINDERS



5 The location of valves in the cylinder head, instead of alongside the cylinders, is of great advantage in laying out the water jackets surrounding the cylinder barrels. The water jacket runs the full length of the cylinder bore, so that the entire piston is always within water-cooled cylinder walls. The result is that the cylinders warm up evenly and therefore expand equally. The cylinder walls, which guide the pistons, therefore remain truly round. This advantage permits the use of closely fitted, lightweight cast-iron pistons. Since both pistons and cylinders are of cast iron, their rate of expansion is equal, so that the close fit is maintained no matter whether the engine is cold or hot. This engineering development contributes to the oil and fuel economy for which the Chevrolet engine is so outstanding.

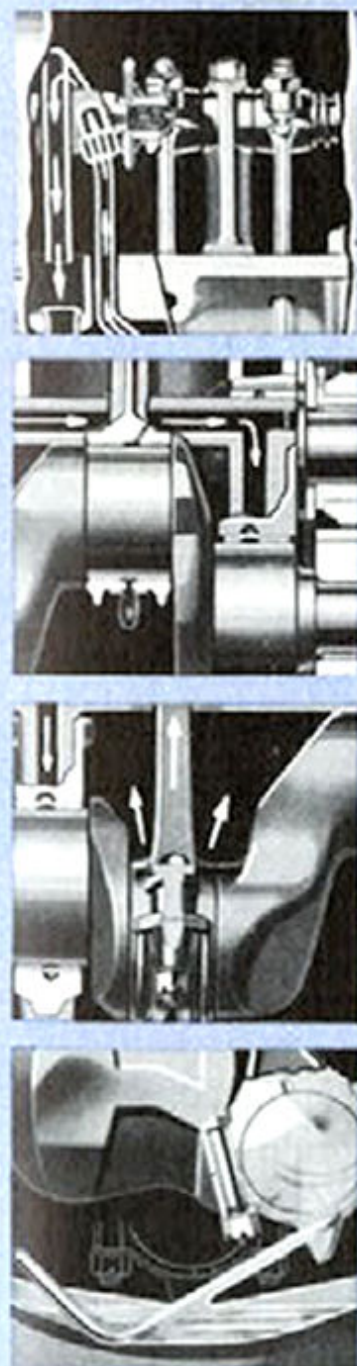

1

2

3

4

ENGINE FEATURES

- 1 Overhead Pipe**—Oil is led to the valve-operating mechanism by a copper tube passing through the engine water jacket; the surrounding water regulates the oil temperature. Positive pressure is maintained at the valve rocker shaft bearings.
- 2 Direct Pressure**—The crankshaft and camshaft are lubricated by oil forced to the bearings through rifle-drilled passages in the engine block. The supply increases with the engine speed.
- 3 Splash**—Piston pins and cylinder walls are lubricated by the splash system; all surfaces are constantly bathed in a heavy mist of oil.
- 4 Pressure Stream**—At low speeds, connecting rod dippers pick up oil from troughs. At higher speeds, jets of oil are forced directly into the path of the dippers. The impact creates a pressure many times greater than that created by the pump.
- 5 Full-Length Water Jackets**—Each cylinder barrel is completely surrounded by water over its entire length.
- 6 Four-Bearing Crankshaft**—The 68-pound crankshaft is forged with integral counterweights. Bearings are above the average in size.
- 7 Leakproof Water Pump**—The ball-bearing pump is self-adjusting—there are no nuts requiring attention to prevent leaking.
- 8 Octane Selector**—The ignition timing may be adjusted to suit any grade of fuel.

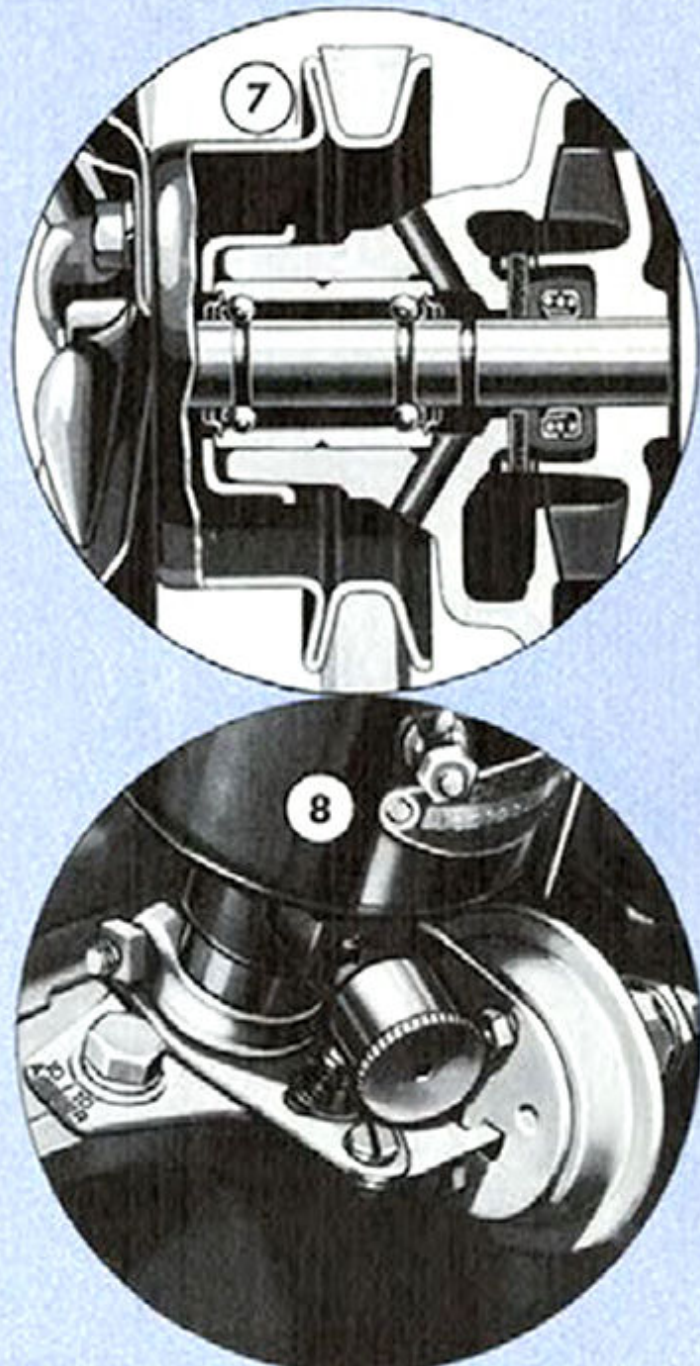

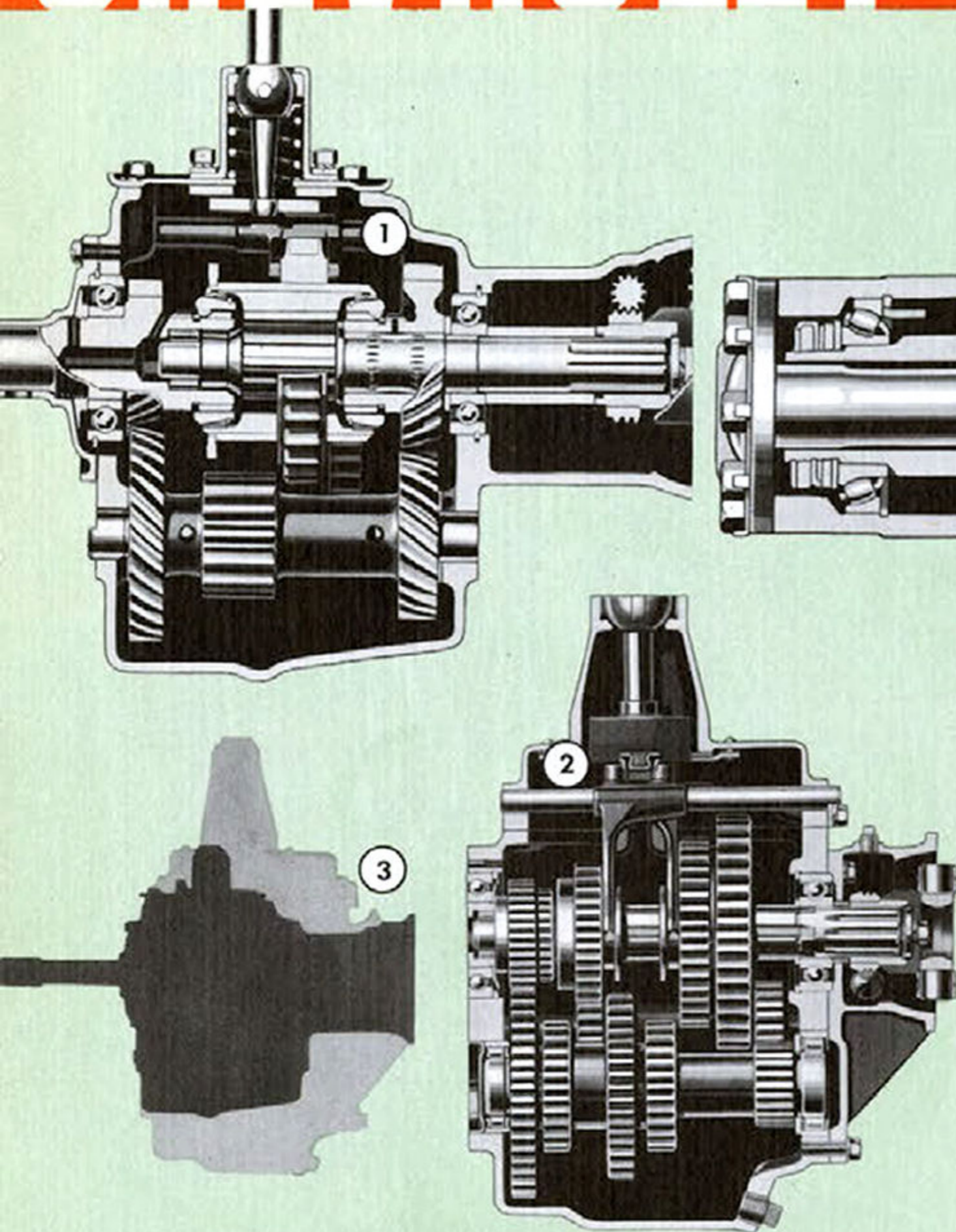

TRANSMISSIONS

- 1 **Syncro-Mesh**—In the three-speed transmission (standard on all but the *Heavy Duty*), the synchronizing mechanism assures easy and silent gear shifting.
- 2 **Four-Speed Transmission**—This sturdy unit is standard equipment on the *Heavy Duty*, and may be readily installed as optional equipment (at a small extra charge) in other models. The main shaft runs on heavy-duty ball bearings, the countershaft on roller bearings. A power take-off permits the installation of auxiliary equipment.
- 3 **Easy Change-Over**—The four-speed transmission fits into the same space as that required by the three-speed transmission.

FULL-FLOATING REAR AXLE (HEAVY DUTY)

- 4 **Wheel Bearings**—Rear wheels run on two widely separated barrel-type roller bearings.
- 5 **Straddle-Mounted Pinion**—Alignment of the drive pinion is maintained by two ball bearings, one of them at the rear of the pinion to resist side thrust.
- 6 **Four-Pinion Differential**—The heavy load delivered by the drive shaft is transmitted through four sturdy pinions.

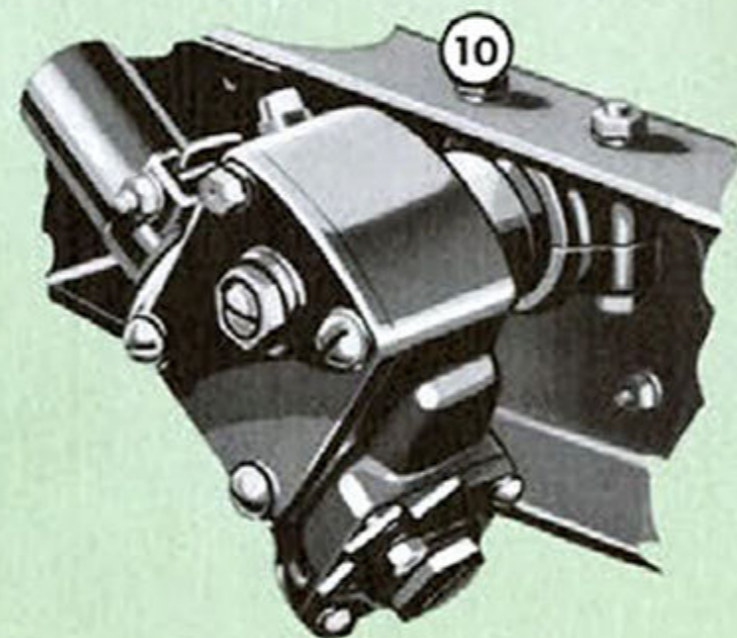
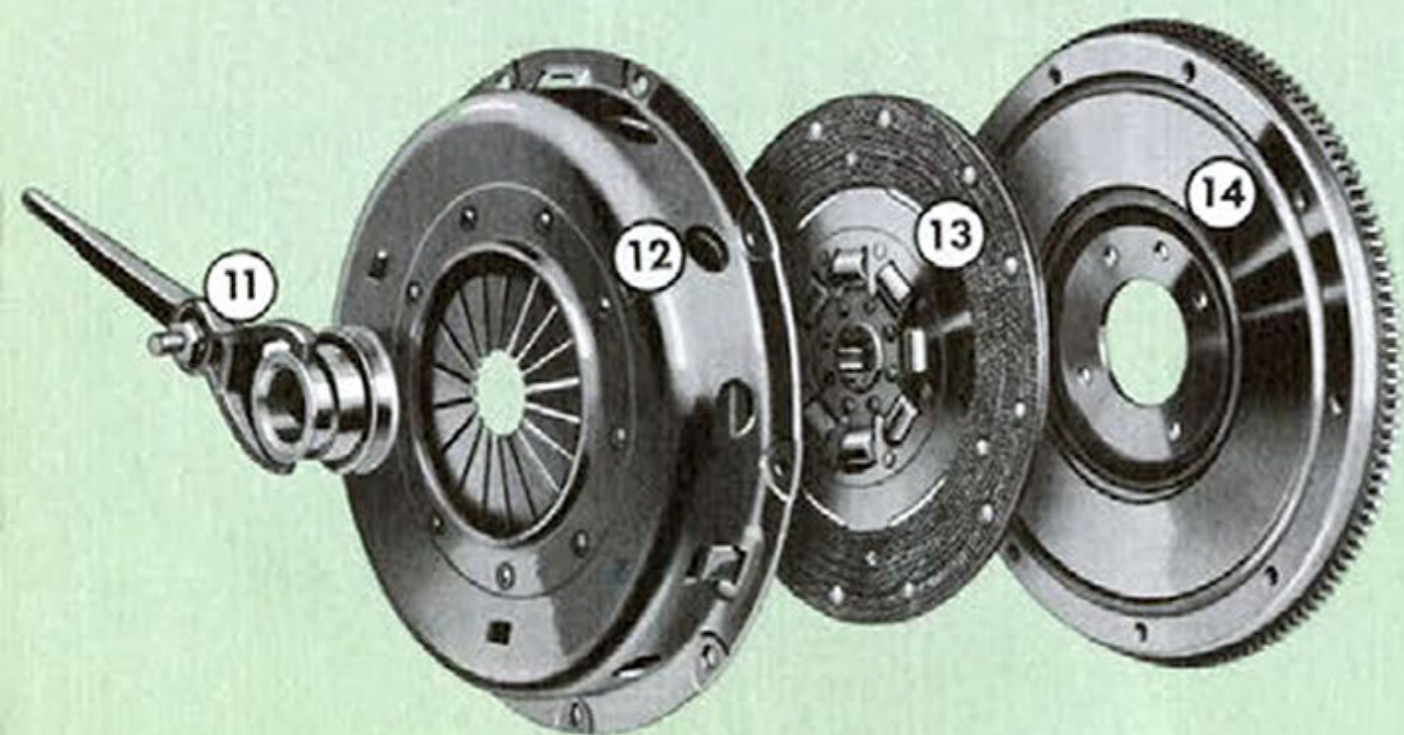

PERFECTED HYDRAULIC BRAKES

- 7 **Double-articulated brake shoes** give full lining contact against the brake drum. Heavy-duty hose connections and copper-plated metal tubing, fully protected by frame members.

FRAME CONSTRUCTION

- 8 **Stabilized Front End**—Radiator, front fenders and headlights are supported as a unit on a centered rubber mounting.
- 9 **Rigid Construction**—The alligator-jaw cross-member ends provide firm bracing for the heavy side-rails.

STEERING GEAR

- 10 **Worm and Sector Steering Gear**—Two widely spaced bearings support the sector shaft, insuring permanent alignment.

DIAPHRAGM SPRING CLUTCH

- 11 **Clutch Throw-Out**—A permanently lubricated ball bearing assures long life and smooth action.
- 12 **Diaphragm Spring**—A tongued disc of spring steel takes the place of eight separate coil springs. A built-in ventilation system prevents clutch overheating.
- 13 **Radial-Wave Disc**—The single cushion mounted plate is formed with radial waves that promote smooth engagement.
- 14 **Flywheel**—The flywheel, which forms the forward pressure plate, is rigid and accurately balanced.

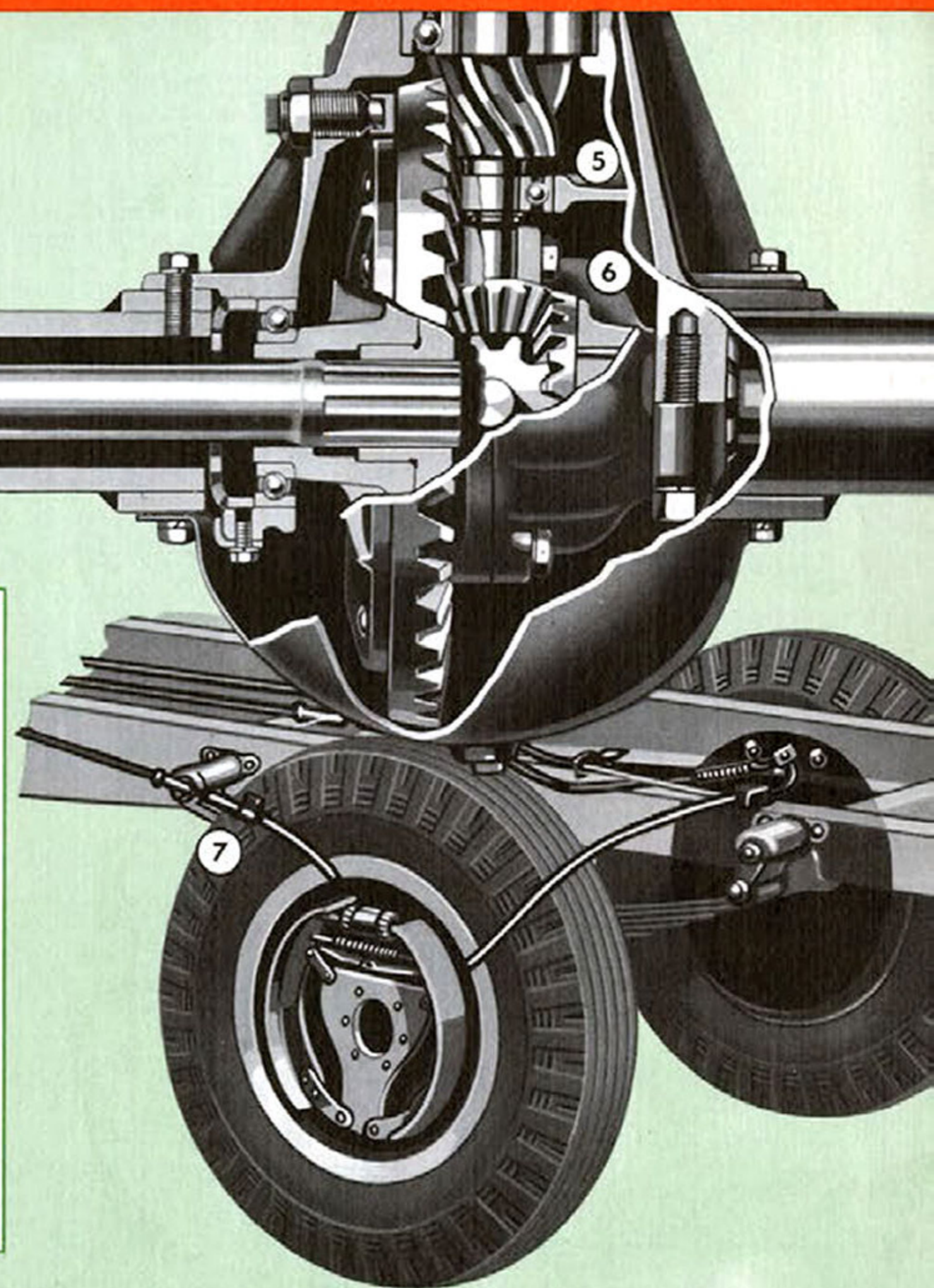
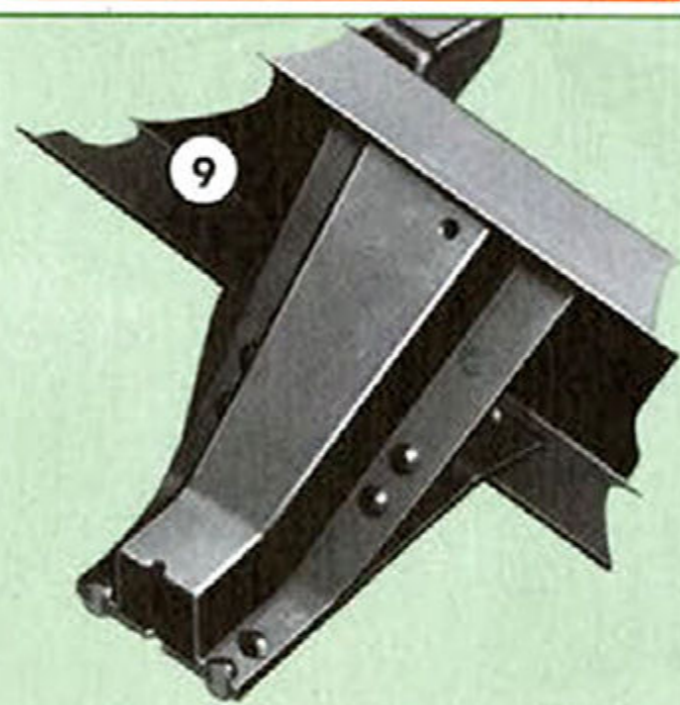

1939 CHEVROLET TRUCK SPECIFICATIONS

ENGINE

Six-cylinder valve-in-head— $3\frac{1}{2}$ " bore and $3\frac{3}{4}$ " stroke. S.A.E. rated horsepower, 29.4. Brake horsepower, 78 at 3200 r.p.m. Rated torque capacity, 170 foot-pounds at 850 to 1550 r.p.m. (85 h.p. at 3200 r.p.m., Sedan Delivery, Coupe Pick-up and Station Wagon.)

- (a) **Crankcase and Cylinder Block**—Cylinder block cast en bloc (including upper half of crankcase); head detachable.
- (b) **Crankshaft**—Drop-forged steel, heat-treated, 4 main bearings.
- (c) **Camshaft**—Drop-forged steel, heat-treated, four bearings.
- (d) **Connecting Rods**—Drop-forged steel, heat-treated; $6\frac{1}{8}$ " long, center to center.
- (e) **Lubrication**—Combination direct pressure, pressure stream and splash system. Gear-type oil pump.

- (f) **Cooling**—Centrifugal water pump, Harrison ribbed cellular radiator core, 4-blade fan. Water capacity, 14 quarts, $16\frac{1}{2}$ quarts, C.O.E.
- (g) **Carburetion**—Specially designed, $1\frac{1}{4}$ " Carter down-draft carburetor. Updraft, C.O.E.
- (h) **Air Cleaner and Flame Arrester**—AC type.
- (i) **Ignition**—Delco-Remy. Octane selector.
- (j) **Generator**—Delco-Remy.
- (k) **Starting Motor**—Delco-Remy.
- (l) **Engine Suspension**—Rubber mountings.
- (m) **Piston**—Slipper type—tin-plated cast-iron. 3 rings above pin—pin bosses are bronze-bushed.
- (n) **Valves**—Intake, $1\frac{1}{4}$ "; exhaust, $1\frac{1}{2}$ ", outside diameter.
- (o) **Crankcase Breather**—Fumes are exhausted by a suction tube to the outside of underpan.

GROSS ALLOWABLE WEIGHTS

(including chassis, cab, body, driver and payload)

Light Delivery—6.00-16, 4 ply tires.....	4400 lb.
Light Delivery—6.00-16, 6 ply tires.....	4600 lb.
$\frac{3}{4}$ -ton—15", 6 ply tires.....	5200 lb.
$\frac{3}{4}$ -ton Special—7.00-17, 6 ply tires.....	5800 lb.

Heavy Duty Conventional trucks and Heavy Duty C.O.E. trucks			
Rear Wheels	Rear Tires	Gross Weight	With Helper Springs and 6.166 axle
Single	32x6, 8 ply	7700 lb.	
Dual	6.00-20, 6 ply	9500 lb.	
Dual	32x6, 10 ply		11,500 lb.*
Dual	7.50-20, 8 ply		11,500 lb.*

*11,500 lb. with governor limiting speed to 45 m.p.h., and front tires 6.50-20, 6 ply, or larger.

	Master 85 Sedan Delivery, Coupe Pick-up & Station Wagon*	Light Delivery	$\frac{3}{4}$ -Ton	$\frac{3}{4}$ -Ton Special	Heavy Duty Conventional		Heavy Duty Cab-Over-Engine (C.O.E.)		Chassis for School Bus	
Wheelbase	112 $\frac{1}{4}$ "	113 $\frac{1}{2}$ "	123 $\frac{3}{4}$ "		133"	158 $\frac{1}{2}$ "	107 $\frac{1}{4}$ "	131 $\frac{1}{4}$ "	193 $\frac{1}{2}$ "	
Back of cab to center line of rear axle	—	38 $\frac{1}{4}$ "	48 $\frac{1}{4}$ "		57 $\frac{1}{4}$ "	83 $\frac{1}{4}$ "	62 $\frac{1}{2}$ "	86"	—	
Center line of rear axle to end of frame	—	36 $\frac{1}{2}$ "		34 $\frac{1}{4}$ "		—		84 $\frac{1}{4}$ "		
Back of cab to end of frame	—	74 $\frac{1}{4}$ "	84 $\frac{1}{4}$ "		92 $\frac{1}{4}$ "	118 $\frac{1}{2}$ "	97 $\frac{1}{4}$ "	120 $\frac{1}{2}$ "	—	
Turning radius—approximate	20'	19 $\frac{1}{2}$ '	21'		24 $\frac{1}{2}$ '	28 $\frac{1}{4}$ '	—		—	
Approximate chassis shipping weights in pounds	Single wheels	—	2210	2430	2575	2985	3060	—	—	
	Dual wheels	—	—	—	—	3125	3200	—	3600	
	With cab, single wheels	—	2600	2805	2970	3355	3430	—	—	
	With cab, dual wheels	—	—	—	—	3500	3575	—	—	
Clutch	{ Disc	9"		10 $\frac{1}{4}$ "		—				
	{ Type	Dry single-plate, completely enclosed. Diaphragm type spring.								
Transmission	3-speed, Synchro-Mesh type	3-speed, Synchro-Mesh type			4-speed, sliding gear type					
	—	4-speed trans. available at extra cost			with provision for power take-off					
Propeller shaft	Tubular steel with solid ends.		Coupling shaft connects transmission and propeller shaft with heavy-duty truck universal joints. Also allows for power take-off.				Tubular Shaft Hotchkiss type	Coupling shaft connects trans. and propeller shaft with heavy-duty truck universal joints. Also allows for power take-off.		2 coupling shafts connect trans. & propeller shaft with 3 heavy "U" joints.
Universal joints	Yoke and ring type.		All-metal type, drop-forged steel yokes				Needle brg.	All-metal type, drop-forged steel yokes		
Steering gear	Semi-reversible, worm and roller		Semi-reversible; roller bearing worm and straddle-mounted sector type.							
Frame	4 $\frac{1}{2}$ " deep 3 $\frac{1}{4}$ " flanges $\frac{1}{2}$ " box section	5 $\frac{1}{4}$ " deep 2 $\frac{1}{2}$ " flanges $\frac{3}{4}$ " channel	5 $\frac{1}{2}$ " deep 2 $\frac{1}{2}$ " flanges $\frac{1}{2}$ " channel	5 cross mbrs.		5 cross mbrs.	6 cross mbrs.	5 cross members		7 $\frac{1}{2}$ " deep 2 $\frac{1}{2}$ " flanges $\frac{1}{2}$ " channel
	4 cross members	5 cross mbrs.	5 cross members	5 cross mbrs.		6 cross mbrs.	5 cross members		8 cross mbrs.	
Front Spring	Semi-elliptic, 36" long, 1 $\frac{3}{4}$ " wide								Semi-elliptic, 40" long	Semi-elliptic, 36" long, 1 $\frac{3}{4}$ " wide
	8 leaves Ride Stabilizer	7 leaves **	8 leaves	9 leaves		8 leaves		10 leaves		
Rear spring	Semi-elliptic 49" long 1 $\frac{3}{4}$ " wide 8 leaves	Semi-elliptic		Semi-elliptic, 45" long 2 $\frac{1}{2}$ " wide, 10 leaves		Semi-elliptic 45" long 2 $\frac{1}{2}$ " wide 10 leaves		Semi-elliptic, 45" long, 2 $\frac{1}{2}$ " wide, and auxiliary spring, 6 leaves.		
		54 $\frac{1}{2}$ " long 1 $\frac{3}{4}$ " wide 8 leaves	45" long 2" wide 9 leaves	Special soft riding spring 8 leaves standard on 133" W.B. Panel		—		—		
Front axle	Drop-forged, heat-treated "I" beam. New Departure ball bearings in wheels.				Heavy-duty drop-forged "I" beam				Extra-heavy drop-forged "I" beam. Roller type king-pin thrust brg.	
	Ball bearings in wheels.				Roller bearings in wheels.					
Rear axle	{ Type	Hypoid gear, semi-floating		Spiral bevel gear, semi-floating		Spiral bevel gear, full floating				
	{ Ratio	3.727 to 1		4.111 to 1		5.428 to 1 (6.166 to 1 ratio optional)				
Brakes	Hydraulic service brakes, front and rear, double-articulated shoe, internal-expanding. Mechanical emergency brakes cut in on rear wheels.									
	11" drums, front and rear, 1 $\frac{3}{4}$ " lining.			11" front drum 14" rear drum	14" front drums, 16" rear drums, 2" front lining, 3" rear lining.					
Wheels	Short-spoke steel disc, integral drop-center rims.			Pierced disc lock ring rim	Heavy dual-type pressed steel wheels—lock ring rim.					
Fuel Tank	18 gallons Station Wagon, 14 gal.	16 gallons 18 gallons in cab			18 gallons			20 gallons		

*Station Wagon also available on Master De Luxe Chassis.

**Ride Stabilizer on Light Delivery Panel truck.

The right is reserved to change specifications, colors or prices without incurring any responsibility with regard to trucks or chassis previously sold. Chevrolet trucks can be purchased on the General Motors Installment Plan—monthly payments to suit your purse. Accessories on all trucks and spare tires on Heavy Duty Conventional, Heavy Duty C.O.E. and School Bus models are at extra cost.