

Price, 10 cents

BULLCK

VOL. 5 · NO. 7

MAGAZINE

FOR

OCTOBER 1939

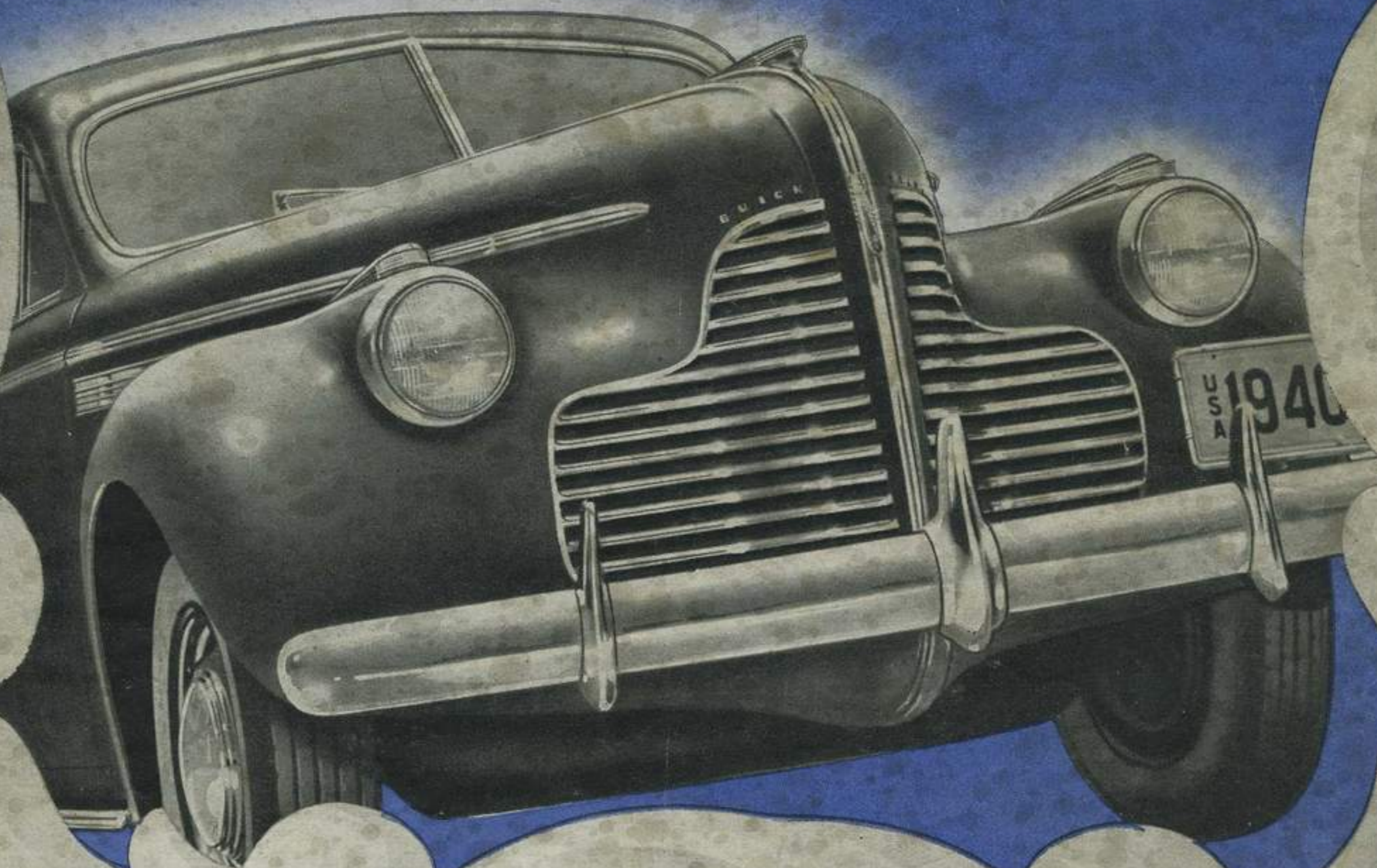

Announcement Number

WHAT'S THE GOOD WORD FOR '40?

"Best bet's Buick!"

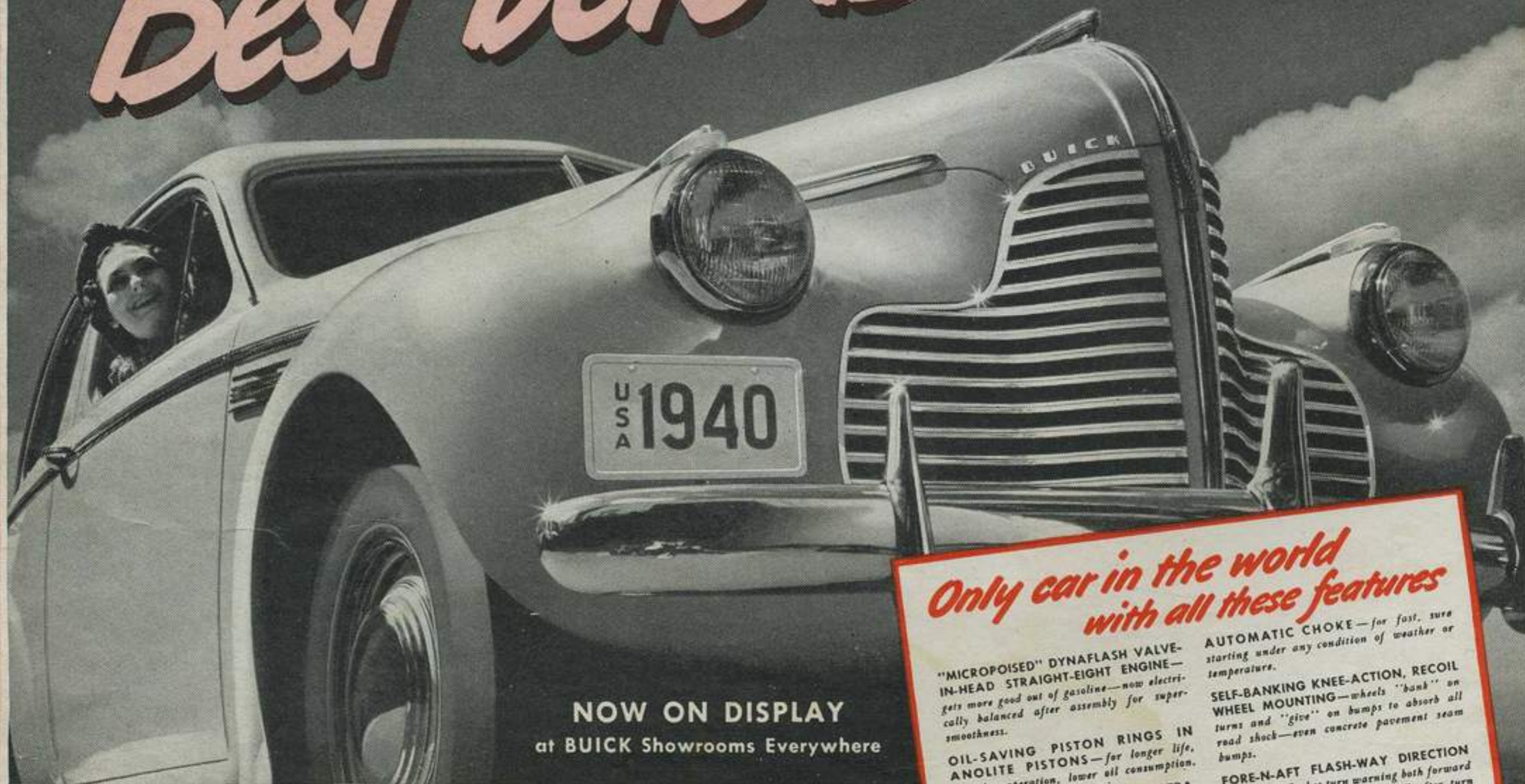

NOW ON DISPLAY
at BUICK Showrooms Everywhere

On top of the \$42,000,000 we've spent for tools, dies and plant equipment in the last four years, we're spending \$8,000,000 more to make sure you get the greatest car that ever graced our name

YOU see pictured here the magnificent automobile that value-wise is next year's No. 1 car.

That's absolute net. We who dreamed it, built it, tested it, tell you cold-turkey it is Buick at its unbeatable best.

Every one of its 12,000 parts is in finish and function a better part than we've been able to make before.

Every one of its 44 different types of steel is the finest for its job that money can buy—five of its special alloys were not even in existence 10 years ago.

When this uncatchable smoothie went fox-footing through its paces on the General Motors proving ground, a ripple of wonder ran like quicksilver through the men who watched its going.

A similar wonder rode with the hardboiled inspectors who hounded it over all the thousands of merciless road-test miles we gave it before we told the production lines: *okeh*, let 'er roll.

You'll feel it—you'll marvel, too—when you feel this incredibly active, staunch, exciting mechanism come alive under your hands—this car that brings to flower the best that Buick knows.

From the velvet velocity of its straight-eight Dynaflex engine to the superb way it handles and answers controls, it's as full of new-day features as an egg is full of meat.

Go see this beauty, drive this dream-come-true! All fire and sparkling spirit, it's a glory of gallantry-and-obedience on wheels.

It's yours for very little more per pound than you pay for a good cookstove.

It's a honey, it's a bearcat, it's a lamb!

Only car in the world with all these features

"MICROPOISED" DYNAFLASH VALVE-IN-HEAD STRAIGHT-EIGHT ENGINE—gets more good out of gasoline—now electrically balanced after assembly for super-smoothness.

OIL-SAVING PISTON RINGS IN ANOLITE PISTONS—for longer life, smoother operation, lower oil consumption.

"CATWALK-COOLING" PLUS ULTRA-RAPID CIRCULATION—complete change of coolant every two seconds.

BUICOIL SPRINGING FOR THE "FULL FLOAT" RIDE—soft, smooth springs of coiled steel, life-time cushioning without lubrication or care.

FULL-LENGTH TORQUE-TUBE DRIVE—in sealed chassis—T-square alignment of rear axle frees rear springs of all jobs but cushioning.

TIPTOE HYDRAULIC BRAKES—one pound of pressure on the brake pedal equals five pounds on each brake drum.

AUTOMATIC CHOKE—for fast, sure starting under any condition of weather or temperature.

SELF-BANKING KNEE-ACTION, RECOIL WHEEL MOUNTING—wheels "bump" on turns and "give" on bumps to absorb all road shock—even concrete pavement seam bumps.

FORE-AND-AFT FLASH-WAY DIRECTION SIGNAL—flashes turn warning both forward and rear, automatically shuts off after turn is made.

STRONGER NEW "DOUBLE WALL" TURRET TOP BODY BY FISHER—Buick developed and Buick styled.

EASY ACTION HANDSHIFTS TRANSMISSION—new firm-linked gear shifting from the steering column.

SAFETY-UNIT HEADLIGHTS—brighter, longer-lasting bulb in one weatherproof unit with lens and reflector—better lighting over a longer period.

Since time and distance make impossible the frequent, friendly meetings which we at Buick would like to enjoy with Buick owners and other motorists, this magazine comes to you as a cordial handshake, assuring you that we are happy to have you and yours as members of the Buick family

It's BUICK . . . at its

UNBEATABLE BEST

By HARLOW H. CURTICE

President and General Manager

Buick Motor Division, General Motors Sales Corporation



Soon, the streets will be sparkling with the brilliant beauty and flashing action of a sensational new line of Buick cars. Here, the president of Buick tells you something of the inside story behind those cars and why he feels they earn the title of Buick at its unbeatable best

ONE of the reasons why I would not change places today with the head of any other automobile company is the very special feeling the public has toward the Buick car.

They approach the idea of owning a Buick with an extreme, not to say unparalleled, sense of expectancy.

They count on Buick to ride smoothly, travel tirelessly, handle easily, serve faithfully. They look to it for all that is good among the new things, yet rely on it to hold fast to all that has been proved fine by past experience.

They expect Buick to do more and to do it better—for the simple reason that Buicks always have.

So they come back to buy, again and again, putting their trust in us not to let their high expectancy down.

Now that attitude is a very fine and a very precious thing.

It is one of our greatest assets.

It is a source of constant satisfaction and continuing inspiration.

And if it occasionally loads us with a heavy responsibility—if it gives us, year after year, the anything-but-easy job of bettering our previous best—I, for one, say so much the better.

For that makes all the more pleasant times like the present, when I stand before the huge jury of Buick friends to present the case for a new and better line of cars.

When expectancy runs high, it is that much more gratifying to be able to say, sincerely and with deep conviction, "Gentlemen, here are your fondest hopes exceeded!"

That I know to be the literal truth about the line of cars we are about to present for 1940.

I know it to be true of every detail of them.

I know it to be true not only of their styling, nor their dimensions, nor their performance and handling and riding qualities, but of the strength of their metals, the precision in every step of their manufacture, the precise and prideful care with which they are made ready for you.

I can say this of the 1940 cars because they, even more than any line that ever preceded them, are not the fruit of any one man's brains or any small group of brains.

They are the richest harvest of all the ingenuity, all the critical concern, all the sincere and earnest pride of the whole Buick organization.

The reason is that our effort for 1940 was not simply to build a new model.

It was an effort to produce a car that would represent Buick at the unbeatable best of all its experience, all its man power, all its fine facilities.

We determined at the very outset that we would not be content to perfect a few features, that we would not be satisfied with a car fine in a few obvious ways! We intended to produce a car that would be better and stronger and more able throughout its whole intricate structure.

Such an undertaking is by no means easy.

It meant combing our whole design not for weak spots but for things that could be made better.

It meant deep study of our engines, serious thought about frames, much brain sweat about bodies, exacting review of every minor detail from the operation of the automatic choke to the brightness of our Flash-Way direction signal bulb.

It meant big undertakings, such as the development of new body structures—and it meant infinite care with little things, such as the thickening of front frame cross members in our Special chassis by a thirty-second of an inch to accomplish a notable increase in steadiness.

It meant calling upon every specialist in design to create his very best work, and then unselfishly to blend that work with that of others to produce a masterful whole.

Months went into their effort. And then, with certain knowledge that our car in its essence was sound and true and right as we could make it, we went on to see what could be added in the way of new things.

We found a number of such things—



new advances, new conveniences, new features big and little. New betterments in styling, new touches in finish, new richness and beauty in appointments. But even there we did not stop.

The whole car had been designed, built by hand, tested on the proving ground when we called a meeting in my office last May.

We gathered there our key men—our engine experts, our gear men, our body designers, our production men. The responsible heads of every department involved in the design and production of a new line were represented.

The time was close at hand for a final, last-word decision. Perhaps these men expected that when they collected.

Instead, they listened to a question, seriously intended and soberly put: "Is there any single thing about these cars—any item, big or little—that you think can be improved? Is there anything in them as they stand that you are not willing to take to market as representing the very best that you personally can conceive or produce?"

Intently these men considered. Deeply they searched their intimate knowledge of this new Buick, of all Buick methods. One by one, they were polled and gave their answer.

A few minor suggestions were made and promptly adopted. Then still another step was agreed upon.

We organized a small jury of men not immediately concerned with the design of the new line. Factory men, servicemen, liaison engineers, they were men who would be concerned with production and after-sale service, but men who had no pet ideas about design to protect.

We sent those men out in three cars—two 1940's and a 1939. Heading south across Ohio, they flung those cars against the grades of the Southern Appalachians, at the back country clay roads of the Deep South, at the marl highways and hard-backed beach sand of Florida.

From Miami, they swung west to the Gulf, around its rim, into Texas, up through Oklahoma and Kansas and home. Five thousand miles they traveled in fourteen brief days—and every mile was as a crucible.



Every mile was searching inquiry into the very heart and core of those new Buicks. Every part, every phase of performance, every action and reaction to bump, rut, curve, grade, wind and road condition were coldly recorded, minutely analyzed, critically weighed, and passed upon.

When those men got back to Flint, we knew we had what we were seeking.

They had some changes to suggest, and we made them; the walls of the torque tube, to cite one of the most important, were made slightly heavier.

But in the main these men could find no flaws, even by their exacting standards.

There was nothing they weren't willing to stand behind.

And since they were the men who would shoulder responsibility should "bugs" develop we could be very sure that they would not fail to report anything on which they had doubts.

So we put the line into production.

It is a line, as you will see, distinguished by one entirely new series, the Super, and a complete redesigning of another.

It is a line containing twenty-two models ranging from our high-value, high-spirited Special through the cyclonic Century and ultrastreamlined Roadmaster to an enlarged Limited Series, which reaches new heights in luxury and fine finish.

It is a line rich in new features, new styling, new roominess, new appointment. It boasts not one improvement but a full six dozen.

But for my part I am not going to go into such specifics. I leave that for others.

What I am deeply sure of, what I want to say to you as sincerely and convincingly as I possibly can, is that here in truth is Buick at its unbeatable best.

Buick strong as only Buick can be strong. Buick eager and alive and waiting to gaily carry you places. Buick finely wrought, precisely and truly made, beautifully and meticulously styled and appointed.

It is a car to which we are proud to give the Buick name.

It is a car that you, who have known so many sturdy Buicks of the past, will be proud to point to as your latest, newest, and finest automobile.



The Buick Magazine is published monthly by the Buick Motor Division, General Motors Sales Corporation, Flint, Michigan, in the interests of Buick owners and other motorists everywhere. *Editor:* H. H. Curtice, president and general manager, Buick Motor Division. *Associate editors:* W. F. Hufstader, vice-president and general sales manager, Buick Motor Division; A. H. Belfie, director of merchandising, Buick Motor Division. *The Buick Magazine* is fully protected by copyright, and nothing that appears in it may be reprinted without special permission. The Buick Motor Division assumes no responsibility for unsolicited contributions to *The Buick Magazine*, except to accord them courteous attention and ordinary care. All correspondence relating directly to *The Buick Magazine* should be addressed to *The Buick Magazine*, Buick Motor Division, General Motors Sales Corporation, Flint, Michigan.

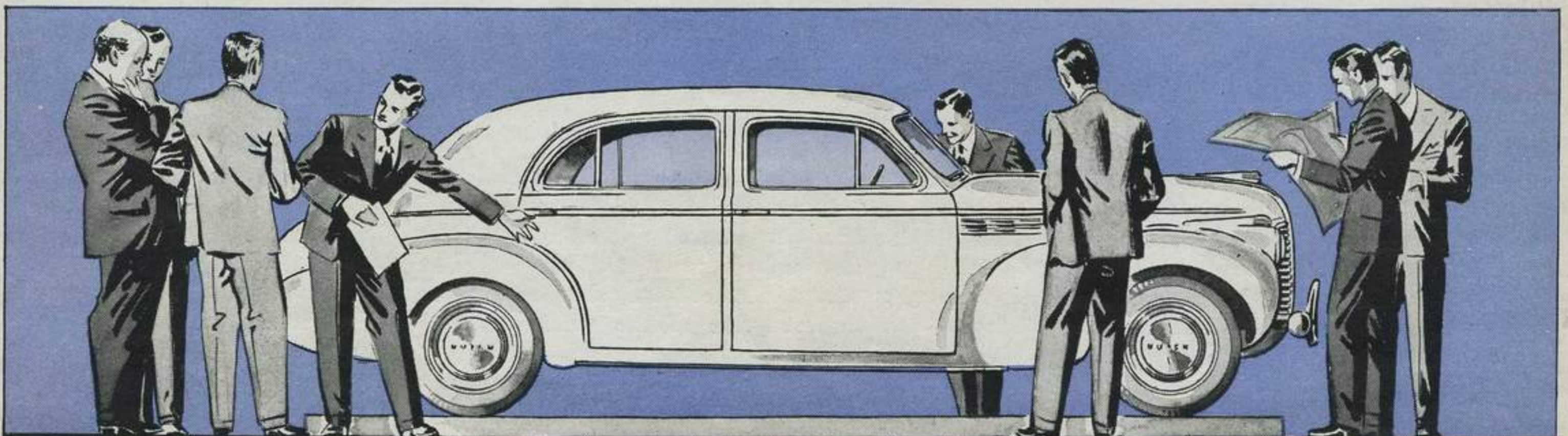

"WHEN BETTER AUTOMOBILES ARE BUILT . . ."

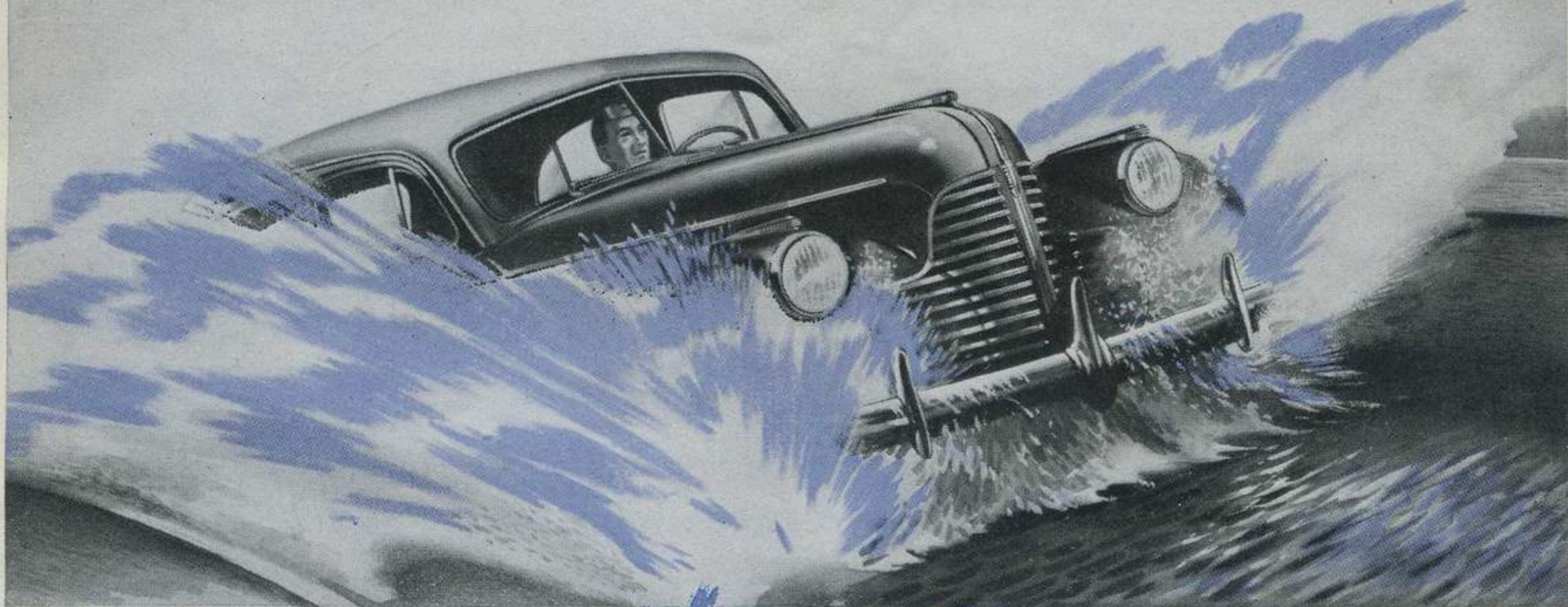

By CHARLES A. CHAYNE

Chief Engineer, Buick Motor Division

BEFORE me, as I write this, is a stack of confidential proving ground reports on the 1940 line of Buicks.

These reports are just about the most technical and impersonal write-ups you'd ever hope to see—they cover the performance of our 1940 cars through about three million miles of grueling tests, and they let facts and figures do all the talking.

They tell us how our 1940 Buicks compare, in side-by-side workouts, with our 1939 Buicks and with 1939 models of every other make of car.

And I don't mind telling you that these reports have made everybody at Buick very happy.

To make a long story short, we've created a car for 1940 that shows more all-over, top-to-bottom, front-to-back improvement than any other car has ever shown in a single year.

That statement is based on proving ground reports.

Buick's famous Dynaflex valve-in-head straight-eight engine, acknowledged to be the most efficient power plant ever built, is

Here THEY ARE

livelier, thriftier, and longer lived because of major improvements in carburetion, cooling, and piston rings. It's even smoother and quieter than before, the result of an amazing new manufacturing development called "Micropoise balancing."

Buick's flat, full-float ride is softer and safer because of recoil action front suspension, revolutionary new shock absorber mountings, and refinements in rear coil spring suspension.

Buick's handling is lighter and more accurate because of steering and spring suspension advancements.

Buick's electrical system, always superior, is much improved by new Safety Sealed Beam headlights, larger capacity generator, improved direction signal system.

We have taken full advantage of improvements in materials and methods to make these 1940 Buicks the greatest

cars ever built, in every way. They represent research, engineering, and manufacturing at its best.

We have made no changes solely for the sake of change. We have not abandoned any of Buick's time-tested fundamentals.

But we *have* made improvements all around—*big* improvements. And bear in mind that every new development was subjected to about one and one half million miles of exhaustive testing before it won a final okay.

More detailed information on our principal developments for 1940 appears on following pages in this magazine. You will enjoy reading it because it gives you a good idea of what *can* be done to make cars better, even during a time when so many automobile men are sighing pessimistically and saying that cars have already reached perfection.

Fulfilling Buick's pledge of progress, the 1940 models bristle with commanding advancements that make them livelier, safer, more comfortable, thriftier, easier to handle, more durable, distinctly superior on every point of performance. And again it's Buick that sets the pace



Ever Drive a *Dream?*

IT'S FAST—RIGHT FROM THE START. Just nudge the starter (it's also the accelerator pedal) and this new Buick Super, Series 50, is ready to whisk you away. There's no noise, no vibration—but *something's about to happen*. You press the clutch pedal down—effortlessly, because it has a helper spring. You finger the Hand-shift lever into low. All right—the clutch takes hold, smooth and firm as a friendly handclasp. You slip ahead like a sudden breeze. One-two with the trigger-quick shift and you're streaming along in high.



TRAFFIC HAS NO TERRORS—This eager performer seems to anticipate your every command. You forget about steering gear linkages, so lightly does it respond to the wheel. A gentle hint from your treadle foot and you're out of a tight spot, into the clear. Nothing short of an electric motor could go to work as smoothly, as suddenly as this great Dynaflex straight-eight engine. It doesn't jump, it doesn't falter, it doesn't strain. It makes speedometers seem ten miles fast—that's the only reason you have to handle it with care.

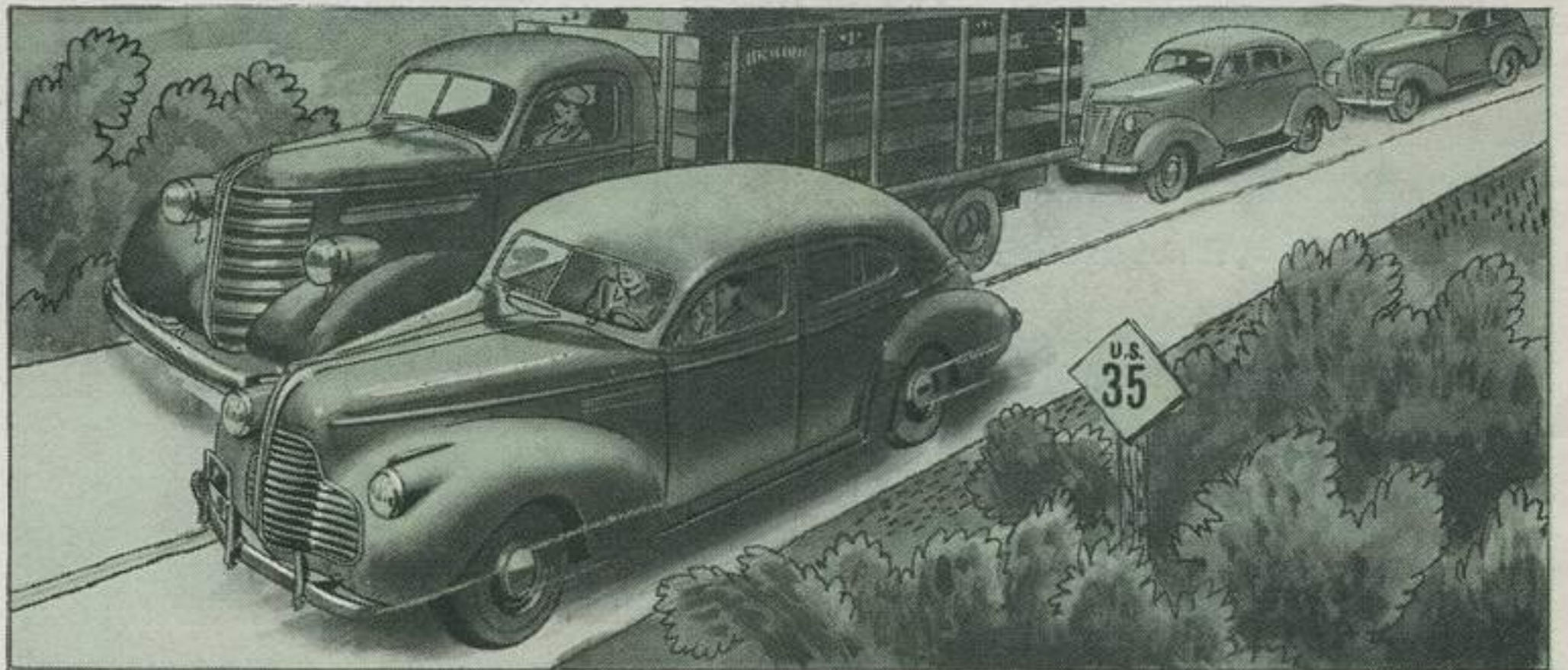

HEAD FOR THE HILLS and give this new Buick a real chance to tell its exciting story. This is a big car; it hugs the road. But you aren't conscious of weight—you breeze over the high ones with laughable ease. And here you notice the turbine smoothness of Buick's power—its engines are now Micropoise balanced, after assembly, to within *a fraction of an inch ounce* of perfect balance—a limit eight to sixteen times closer than last year's best. But that's just one of many advancements that make this engine livelier and smoother running.



CURVES SEEM BANKED for you—that's what Buick's self-banking Knee-Action does for your comfort and safety. You notice, too, how steadily, how accurately this car holds its course. There's no wheel tug, no shying away from side winds, no sway. Thank Buick's semireversible steering and stabilized torque-free springing, its high roll center and low center of gravity for all that. Buick's rear coil springing, with transverse radius bar, has been improved to further eliminate fatigue. But Buick's real ride story is yet to come . . .



Until you've let this new Buick tell you its own exciting story—in action
—you'll think everything we say about it is an exaggeration!



WASHBOARD ROADS are the true test of Buick's improved, full-float ride. The Knee-Action front wheels "give" slightly to the bumps—they move back a little as they move upward—just as a ballplayer lets his hand give to a catch. Road bumps are sponged up before they can reach the body. The easy-flexing Buicoil rear springs are now directly in the line of impact, and improved shock absorbers, now mounted on the rear brake backing plates, are more effective in controlling the ride. There's nothing else like it.



AND TALK ABOUT SILENCE!—just wait until you take the new Buick over a rough brick pavement—the growl is gone. You drift along, quiet as an airplane's shadow, because silent zone body mountings smother all chassis vibration at points where the body is secured to the frame. And Buick's luxurious new bodies by Fisher are still more effectively insulated against outside noises and heat. In Unisteel Turret Top bodies by Fisher, the insulation is *padded* on in precise quantities, not just smeared on.

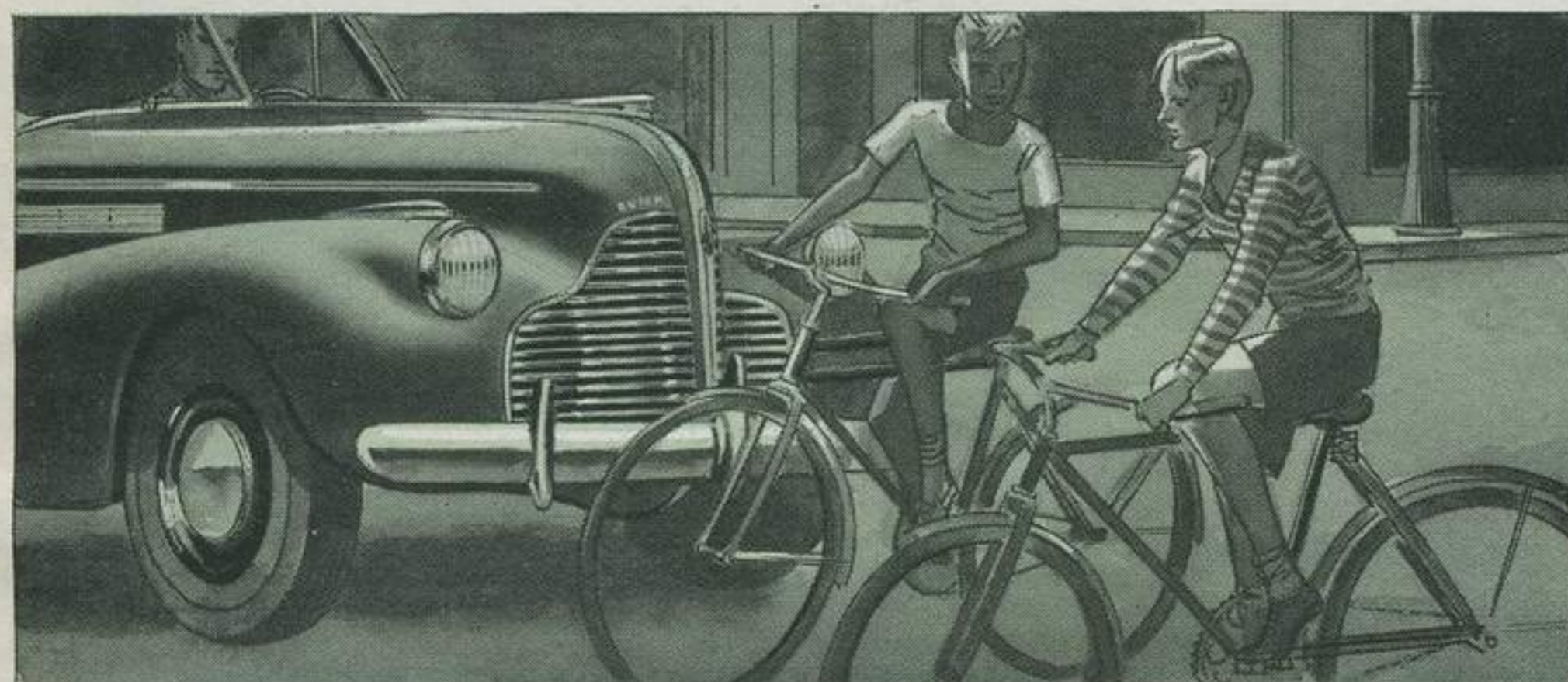

SAFETY-CERTAIN STOPS are yours in the new Buick. Giant hydraulic brakes ease you down quickly, smoothly, in a straight line. You don't have to tramp on these brakes—they're self-energizing, more responsive. And they wear longer, more evenly—require fewer adjustments—because their shoes are more efficiently linked. As in the past, Buick's husky torque tube withstands all the twist that comes with stopping as well as the driving torque. On conventional cars, the rear leaf springs must absorb these strains.



IT SHEDS WATER like a hustling duck, this Buick does, because its body and chassis are perfectly sealed against the weather. You can leave a Buick out all night in a buckets-down storm and then start it like scratching a match—you and your family will never find yourselves stalled by the wayside. In wet weather, you'll grow very fond of Buick's safety springing and steering, Buick's rain-defying ventilation, Buick's pair of capable windshield wipers. And don't forget—it'll master winter blizzards as well as autumn downpours.



You can enjoy all the fresh air you want, in a new Buick, without ruffling your permanent—the no-draft ventilation controls are at your finger tips

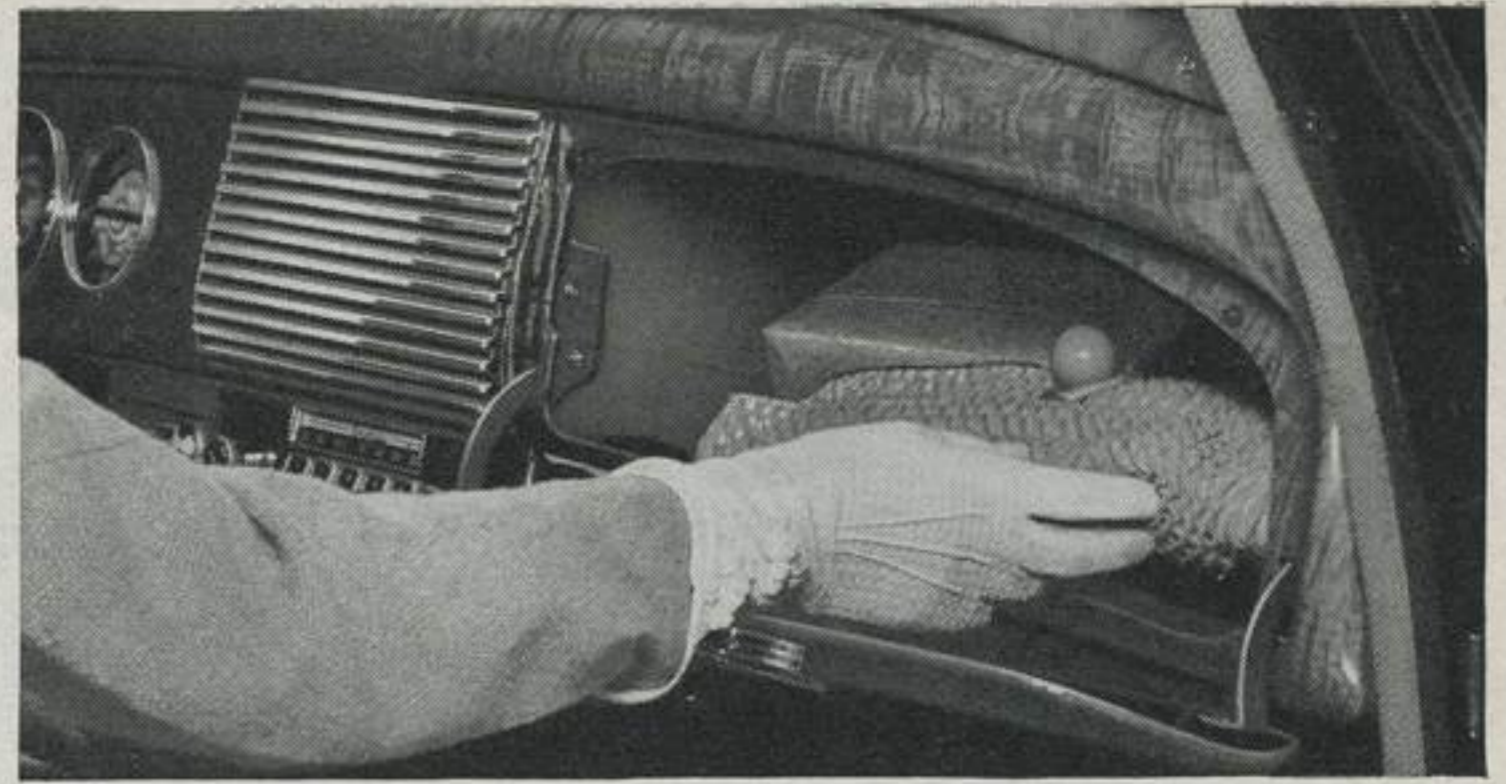

It's as good as a wall safe, this roomy dash compartment, because you can lock it, on parking lots, and take your key with you. And, speaking of locks, Buicks have them on both front doors



The fine quality of Buick seat construction and trim is clearly apparent to the touch. On the Super, Century, Roadmaster, and Limited models, you enjoy the extra comfort of Foamtex rubber. And don't forget that Buick seats are just as spacious as they are gracious

How to make a hit with the WOMEN

Buick shows you—with comfort and handling controls at her finger tips, luxuriously individualistic interiors, and more real riding and driving ease than she has ever known. What's more, this is the safe and dependable kind of car a lady prefers to have

WOMEN are mechanically minded. Don't let anyone tell you differently! They may not give a hoot for technical terms, but they do appreciate responsive power, handling that's light as vapor, chaise lounge comfort, lasting security—all the good things that spring from advanced engineering.

Women have always been partial to Buick for its out-front performance qualities. But they also like it—more every year—for its refreshingly beautiful styling, its tastefully luxurious interiors, its many thoughtful conveniences.

In fact, about the only way to keep a woman from choosing a new Buick for her own is to command her, sternly and with considerable shouting, never to get acquainted with one.



Handling a new Buick is just about as simple as maneuvering a new vacuum cleaner around the room—you can finger it through traffic, hold it to a hair-line on the highway without a fret or a frown. The Handi-shift lever has a helper spring at your service, and so has the clutch pedal. You can signal your turns and blow the horn without taking your hands off the wheel. Everything's arranged to make you feel very confident indeed



Just trip this convenient release and you can adjust the front seat to a perfect fit, without taking your eyes off the road. The seats rise and tilt slightly as they are moved forward, offering perfect accommodations for the smallest driver

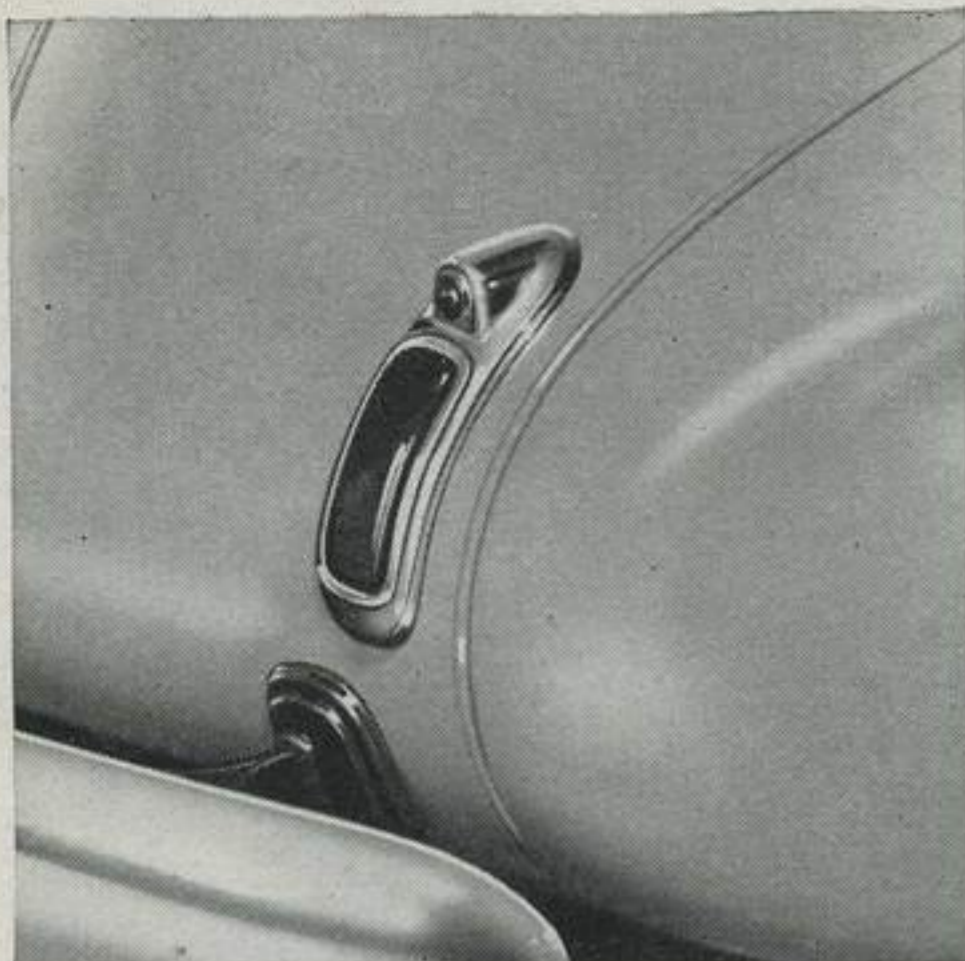

Buick has dual taillights as standard equipment. Above each light is a high-intensity reflector—to protect you in the event a bulb burns out; to protect your car when it is parked with the lights off

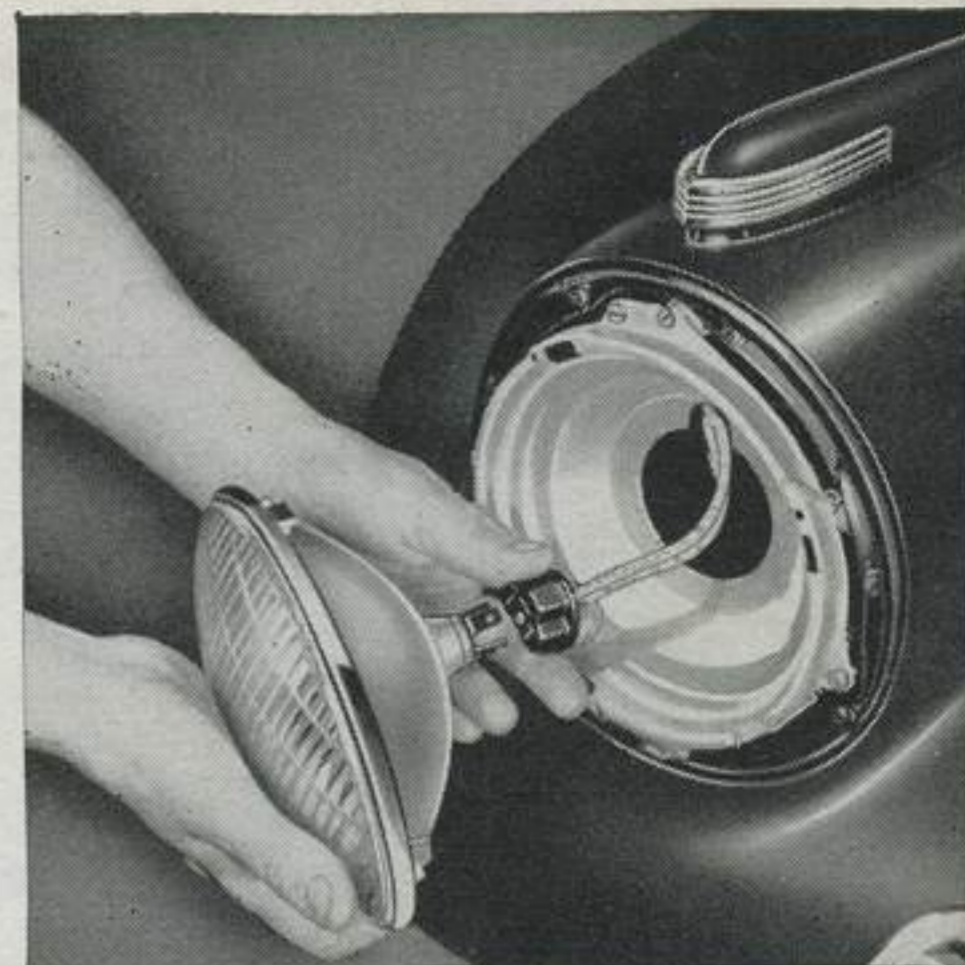

The Safety Sealed Beam headlight—reflector, bulb, and lens—is hermetically sealed against the weather, to prevent loss of brightness. This is one of the biggest advancements in safe lighting ever made

See be Seen and be Safe...

HERE'S a quick version of the story behind the new Safety Sealed Beam headlight:

General Motors research engineers bought a fleet of used cars of various makes and ages and recorded their headlight efficiency. The engineers then installed new headlights of exactly the same type as the used cars' original equipment and made a second efficiency record to compare with the first one.

This is what they found out: Headlights, in four years' time, could lose as much as three fourths of their original efficiency. And most of this loss could be traced to weathering of the reflector and inside of the lens.

So the engineers developed a Safety Sealed Beam headlight, hermetically sealed against weather. Its reflector cannot get

Buick answers the modern demand for more powerful light, that will always stay bright, with a Safety Sealed Beam headlight—and offers a perfected, practically automatic Fore-n-Aft Flash-Way direction signal

dull; the inside of its lens cannot be filmed by grime.

If the lens is broken on this Safety Sealed Beam headlight, or if a bulb burns out, a complete new unit can be installed at very

low cost, which renews the original lighting efficiency.

Along with this new Safety Sealed Beam headlight construction, Buick has increased headlight power. Buick's new lights put about forty-five per cent more light on the road—almost half again as much as the old-style lights. The capacity of Buick's husky, high-output generator has been raised accordingly.

Just as important as the Safety Sealed Beam headlight is Buick's Fore-n-Aft Flash-Way direction signal. Signal lights, mounted on the rear panel and on the headlights, tell motorists meeting you, and following you, which way you intend to turn. This improved signal system switches off automatically after the turn is made.

Buick's Fore-n-Aft Flash-Way direction signal operates like this for a right turn, just the opposite for a left turn: The lady moves handy signal lever down. Right front signal light and right rear signal arrow flash turn warning to the front and to the rear. Simultaneously, a green light blinks on the right-hand dash instrument, verifying the signal for the driver's own information. The signal lever returns to off position automatically after a turn, or it may be turned off manually

Research engineers report that old type headlights lose as much as three fourths of their original efficiency in just four years' time. This discovery led to development of the Safety Sealed Beam headlight

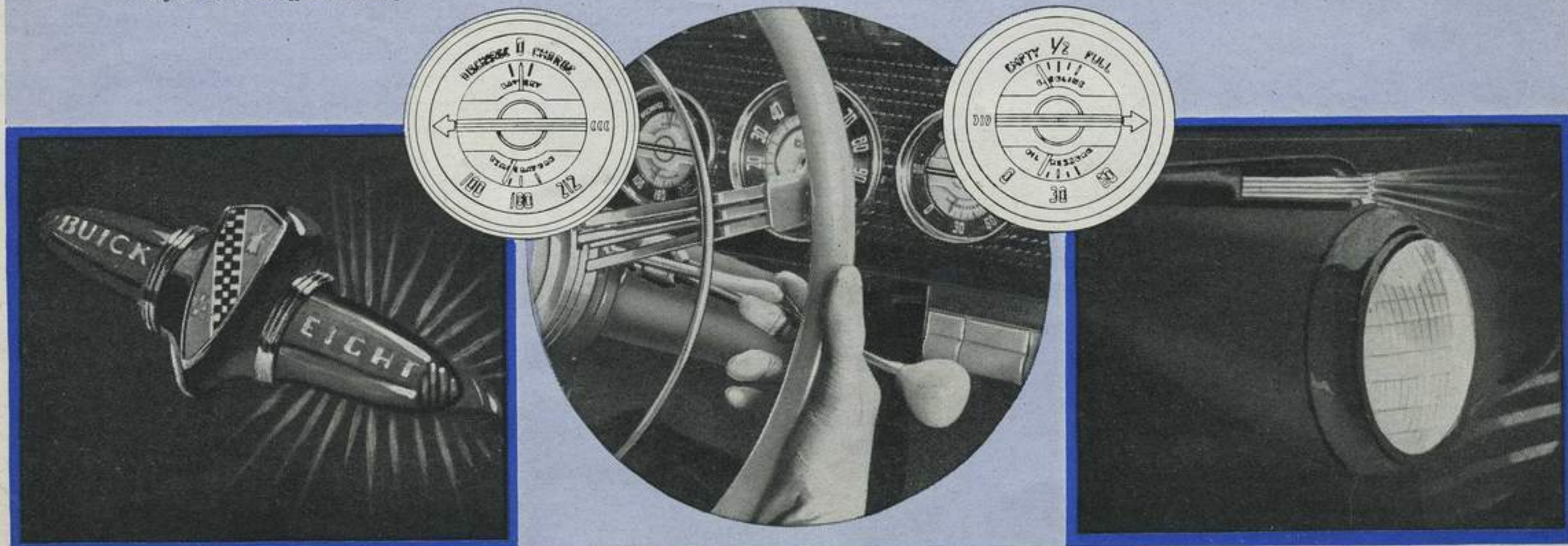
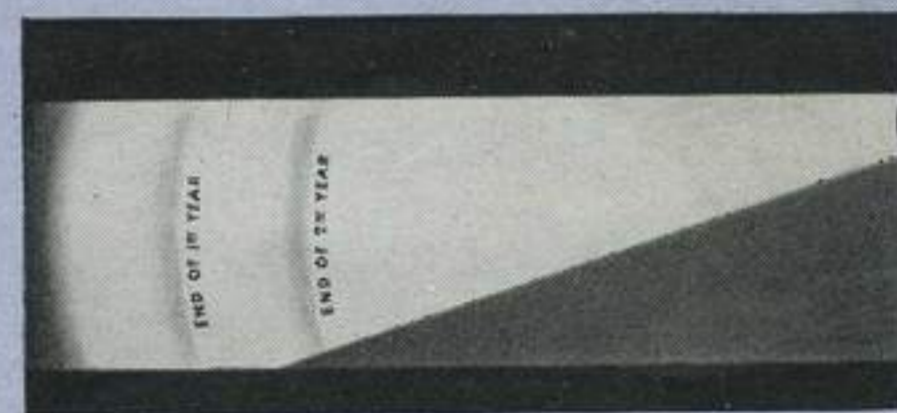

Buick's Chassis is Buick's

Developments for 1940 make it sturdier and more dependable than ever

Pride

THANKS to the magic of Micropoise balancing, Buick's straight-eight engine for 1940 is smoother running, size for size, than a high-grade watch.

After assembly, each engine is mounted on a steel bed and spun at top speed by electricity. A metal pointer resting against the bed detects every hint of vibration and translates it to a beam of light that dances on a ruled chart.

The light tells not only how *much* vibration there is but *where* it is. Metal is then carefully taken off the flywheel to bring the engine within a *fraction of an inch ounce* of perfect balance—a limit eight to sixteen times closer than ever before.

Many developments contribute to this increased smoothness of performance.

An improved starting motor switch ends clashing of starter gears. A new "blocking cam" automatically positions the starter pedal for either hot or cold starting, speeds cold-weather starts, ends restarting trouble when the engine is in a semiwarmed-up condition.

A new automatic choke stove shortens the warm-up period, in the interest of economy. A lighter choke thermostat makes for steadier engine operation; it ends overloaded conditions, especially when accelerating a cold engine.

An improved accelerating pump provides quicker acceleration at low speeds. Lasting thrift life is assured by the elimination of metering pins; there are no longer any internal moving parts in the carburetor

to wear out and lower the operating efficiency.

Pressure cooling has been adopted, with new grille design, and with a new top tank which reduces cooling solution loss from expansion by raising the boiling point of the solution.

A new piston ring development guarantees that the 1940 Buick engine will stay livelier longer by providing a tighter, more enduring seal against blow-by (compression

Here, you see the triumph of a principle—the Buick Dynaflash valve-in-head straight-eight engine for 1940. Like all its predecessors for thirty-six years, it has the basic advantage of valve-in-head design, making it more powerful than any other type of engine, size for size. Now, with Micropoise balancing, its operation is smoother than a fine watch.

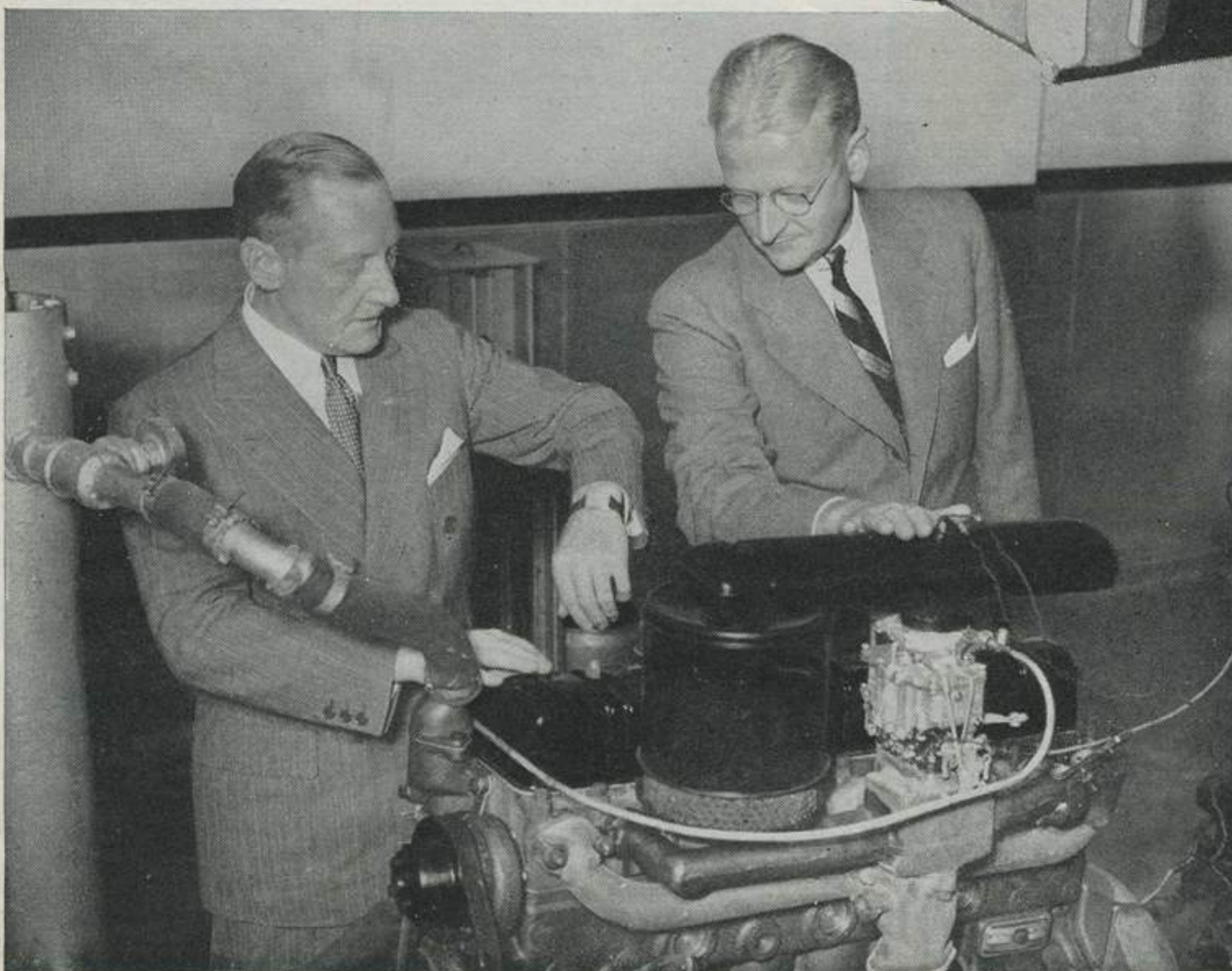
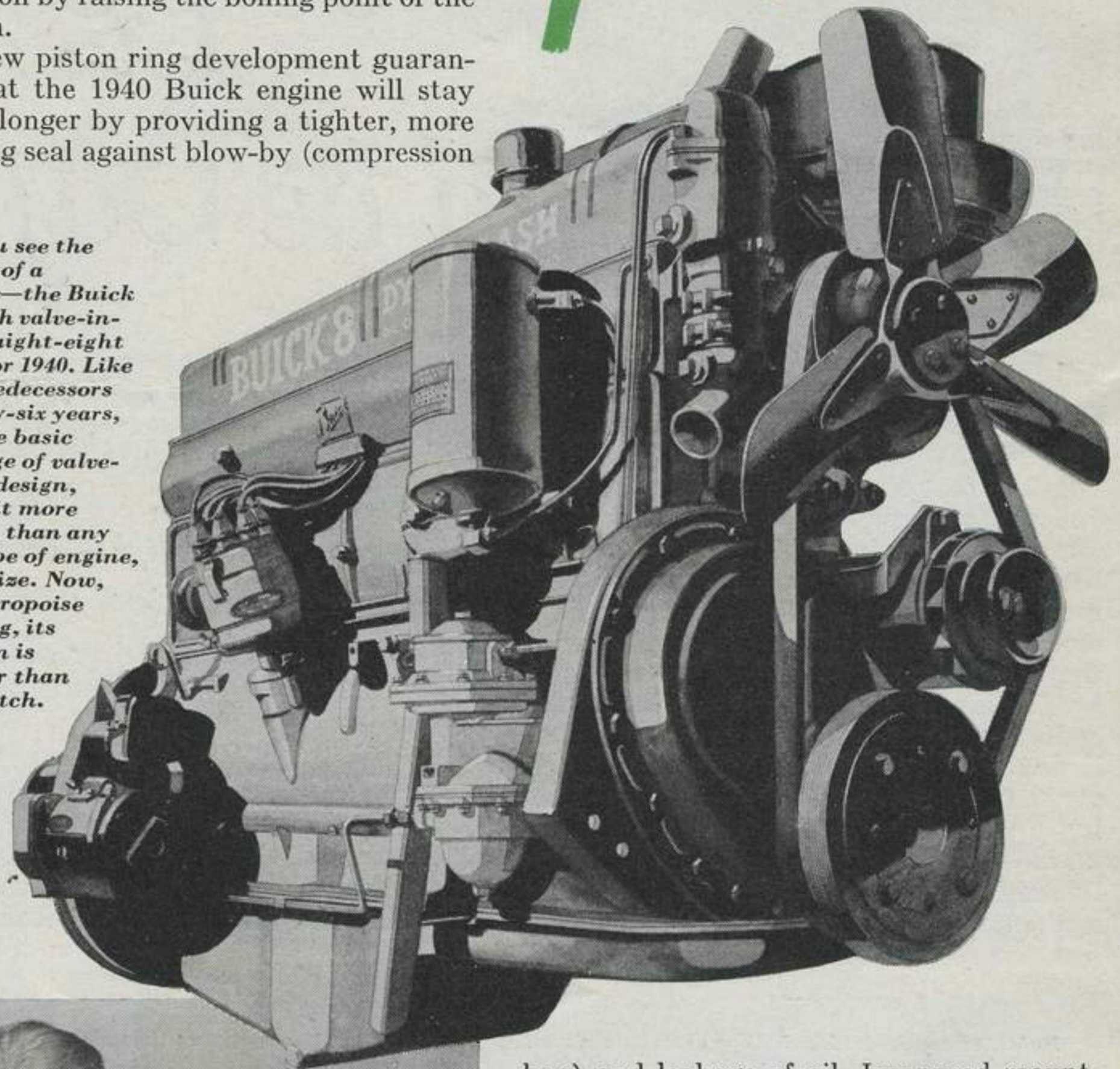

loss) and leakage of oil. Improved mountings offer maximum resistance to vibration and noise transfer and make for greater stability.

A Sound Principle and Constant Improvement

These developments have been possible only because of the sound principle of Buick engine design in the past. Buick today still adheres to the valve-in-head principle of engine design, which it pioneered thirty-six years ago.

It does so because a valve-in-head engine is an easier breathing engine. It takes in gasoline vapor and expels exhaust gases through valves directly over the combustion

"Pound for pound, this new 1940 Buick Dynaflash valve-in-head straight-eight engine is smoother than a high-grade watch." Such is the assurance given to President Curtice and Chief Engineer Chayne by the test they are observing here. Like every Buick engine for 1940, this one is electrically balanced to within a fraction of an inch ounce

No other car can duplicate the safety and comfort of Buick's flat, full-float ride, because no other car has duplicated the engineering features behind this famous ride. As shown on the Series 50 chassis pictured here, Buick has self-banking Knee-Action with recoil action suspension. In the rear, Buick has twist-free coil springs constantly controlled by efficient shock absorbers mounted on the rear brake backing plates. A transverse radius bar prevents sidesway, while a rigid torque

tube and two channel section strut rods hold the rear axle in T-square alignment. This ride was the first to be designed specifically for the modern motorcar. Buick pioneered it, and Buick has refined it to its present superior form.

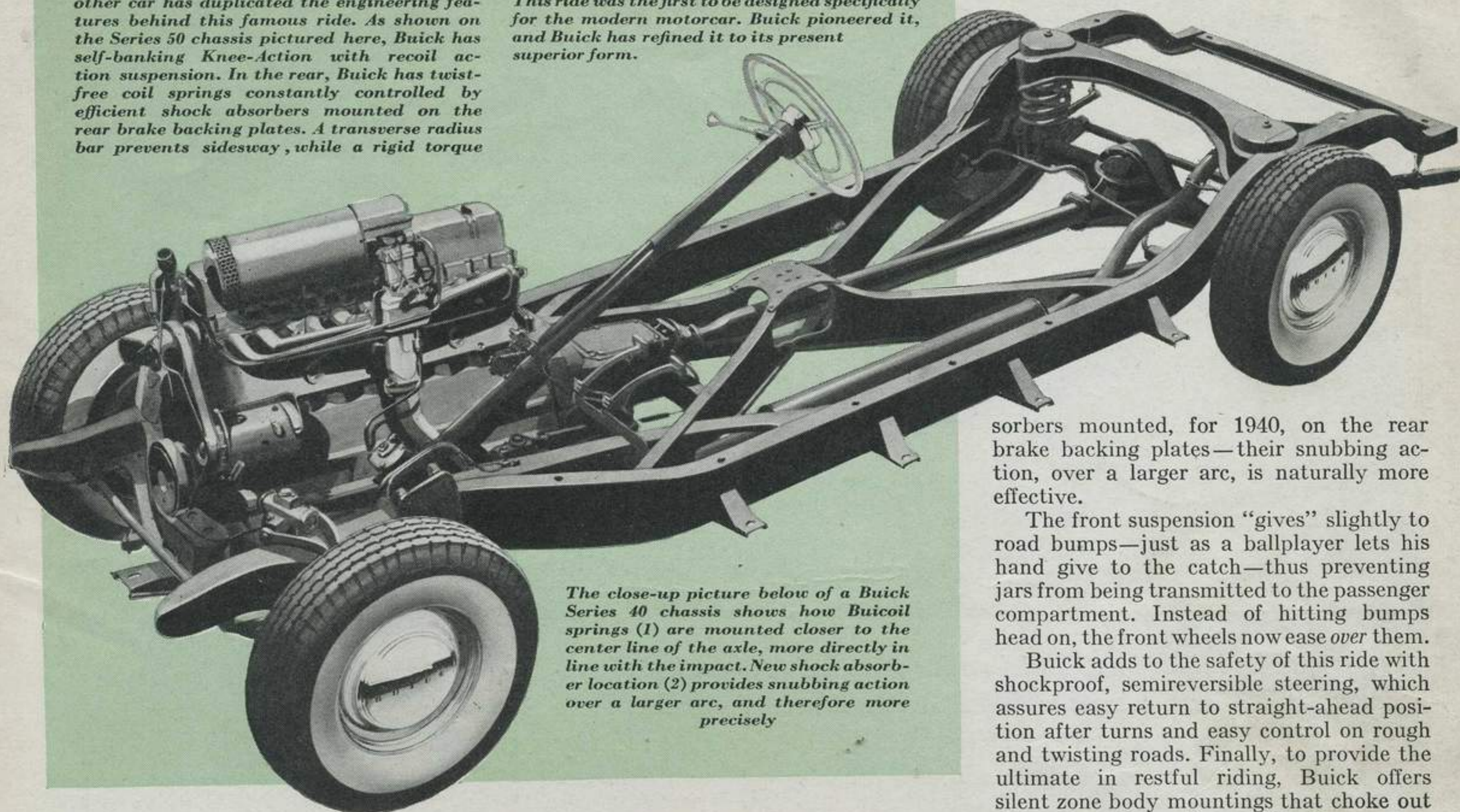

The close-up picture below of a Buick Series 40 chassis shows how Buicoil springs (1) are mounted closer to the center line of the axle, more directly in line with the impact. New shock absorber location (2) provides snubbing action over a larger arc, and therefore more precisely

sorbers mounted, for 1940, on the rear brake backing plates—their snubbing action, over a larger arc, is naturally more effective.

The front suspension “gives” slightly to road bumps—just as a ballplayer lets his hand give to the catch—thus preventing jars from being transmitted to the passenger compartment. Instead of hitting bumps head on, the front wheels now ease over them.

Buick adds to the safety of this ride with shockproof, semireversible steering, which assures easy return to straight-ahead position after turns and easy control on rough and twisting roads. Finally, to provide the ultimate in restful riding, Buick offers silent zone body mountings that choke out all road rumble and frame vibration.

chamber. That's why it is so lively and clean running. A further advantage is that combustion energy is concentrated directly on the pistons—more energy is used as power, less is wasted in heat. That's why this engine is so thrifty—ten per cent more efficient than conventional engines of equal size and compression.

As the result of constant development year after year, Buick's valve-in-head engine now has aluminum rocker arm shaft brackets for consistent quiet operation; full-pressure lubrication; crankcase ventilation; thermostatically controlled pressure cooling; Aerobat carburetor; Turbulator Pistons of anodized aluminum for maximum lightness and durability.

Add the 1940 developments to all these previous advancements and it is easy to understand why Buick's Dynaflex valve-in-head straight-eight engine is the greatest under-the-hood personality in the automobile industry.

No Compromise Between Comfort and Safety in Buick's Coil Spring, Full-Float Ride

Buick pioneered open type coil spring Knee-Action in 1934. Most cars are now using that form of front suspension.

Buick pioneered coil spring rear suspension in 1938. It was being copied the following year. Now, for 1940, Buick again steps out ahead of the crowd.

The perfected and popular flat, full-float ride—recognized by impartial authorities as the first truly automotive ride—has

been distinctly refined all around. It is better controlled, softer and still safer, and makes for lighter and more accurate handling. And, as before, it puts a stop to “tail wag” in stiff cross winds, positively ends over- and understeering on turns, reduces the risk of skids, and lengthens tire life.

It accomplishes all these things in a very logical way.

Buick's rear axle is held in T-square alignment by a rigid torque tube, with channel section strut rods for extra bracing. In addition, a substantial radius rod provides for transverse alignment. On conventional cars lacking torque tube drive or its equivalent, the rear axle is held in alignment by the rear springs.

On Buick, with torque tube drive, the rear springs have just one job—cushioning the ride. Consequently, softer, easier flexing springs may be used—coil springs, which have already proved their cushioning superiority in Knee-Action units and in our rear suspensions since 1938.

The lively action of these rear Buicoil springs is kept under constant control by improved shock ab-

Economy Rear Axle Ratio Yours at No Extra Cost

Rear axle ratios on Series 40 and 60 Buicks are optional. You can have the standard ratio or the economy ratio, at no extra cost.

On Series 40 (Special), the economy ratio gives you about two extra miles to the gallon of gasoline, at speeds of from thirty to seventy miles an hour, and increases top speed about two miles per hour. It also gives about two hundred additional miles to the quart of oil.

On Series 60 (Century), the economy ratio gives you gasoline mileage which approaches that of the Series 40 with standard ratio.

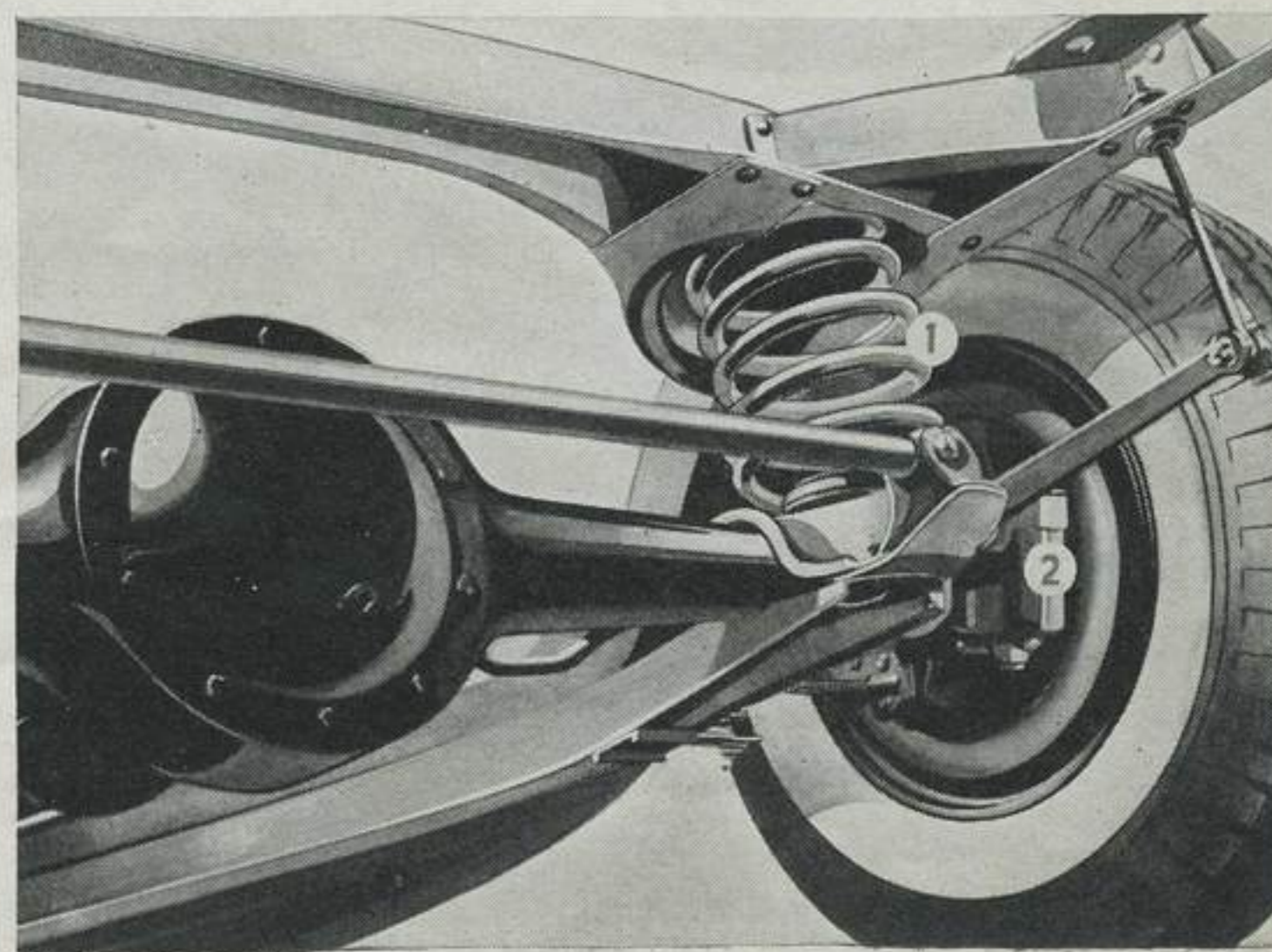

Biggest buys for *little ones*

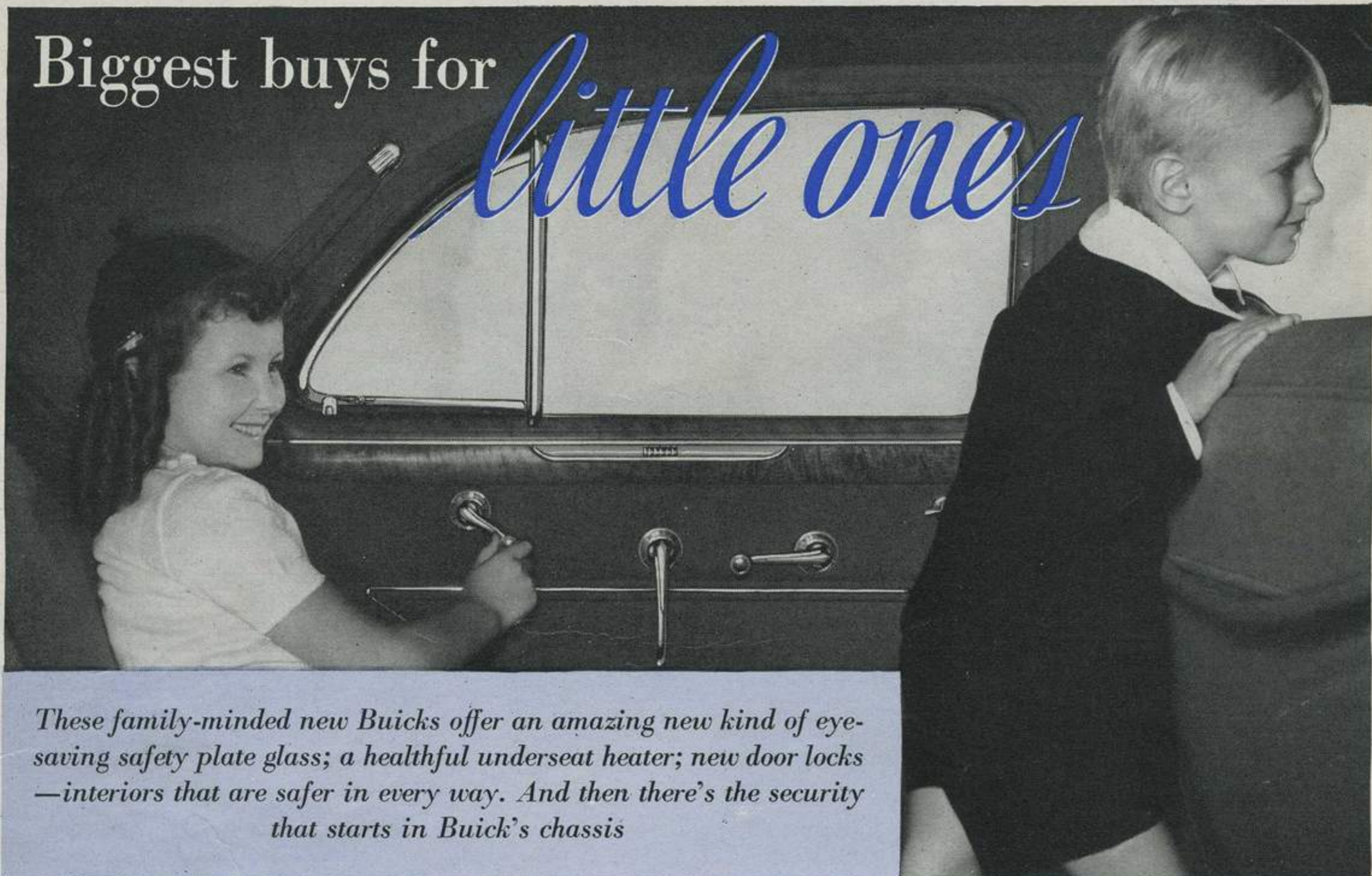

These family-minded new Buicks offer an amazing new kind of eye-saving safety plate glass; a healthful underseat heater; new door locks —interiors that are safer in every way. And then there's the security that starts in Buick's chassis

You say you wouldn't trade 'em for a million—those youngsters of yours. Well, Sir and Madam, the men who build Buicks have youngsters, too, and they feel the same way about them.

That's one reason they give you enough power to whisk you out of traffic pinches; springing that keeps your car going where you point it; steering that never fights back; hydraulic brakes that ease you down to quick, sure, straight-line stops.

That's one reason Buick's builders offer Safety Sealed Beam lighting, a Fore-n-Aft Flash-Way direction signal, an amazing new kind of safety plate glass, a new underseat heater (available as an accessory), new inside door locks, and a whole lot of additional health-minded, safety-making features. Part of the Buick family-car story is covered here—the whole story awaits you at your nearest Buick showroom. Go get it. And be sure you take the youngsters along.

The outlook is grand for young Buick enthusiasts—a new kind of safety plate glass, awaited for six years, saves their eyes and protects them against injury; no-draft ventilation gives them plenty of fresh air without drafts; a new underseat heater (available as an accessory) gives them the equal of home heating; there's a soft roll atop the front seat-back to eliminate chin bumping. And here's something else that helps your peace of mind: all Buick rear doors can be locked from the inside, and cannot be unlatched accidentally. Besides all these interior safety features, Buick offers a degree of safety in power, ride, steering, and braking that is unmatched by any other car



The underseat heater, with fresh air intake, provides healthful heat for passengers in both front and rear compartments. It's really advanced home type heating on wheels. This heater is available as an accessory

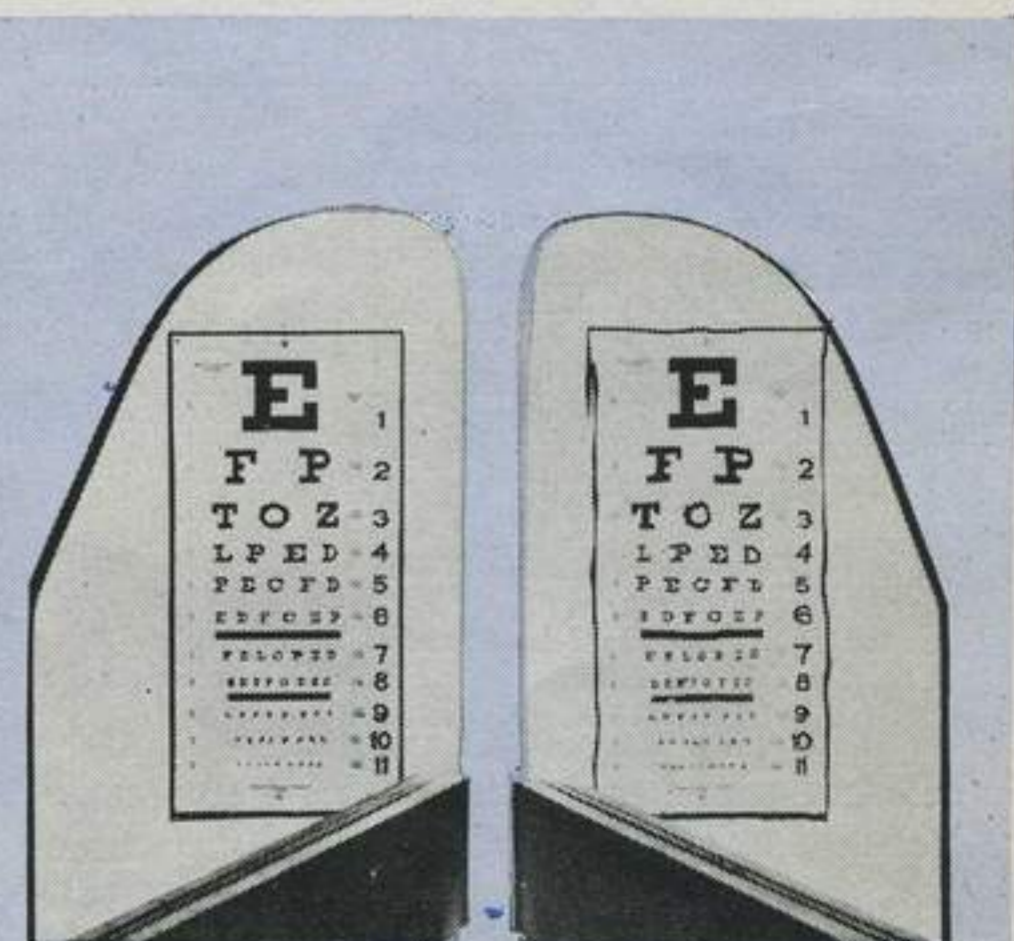

(A)

(B)



It took over six years of research and six million dollars to develop the new safety plate glass that Buick uses. See how this eye-saving new glass (A) compares with ordinary safety sheet glass (B) in the unretouched photographs at right. Notice, too, that no matter how much it's hammered the new safety plate glass can be rolled up like a carpet, as shown at left—the improved inner layer of plastic still holds all the glass fragments

Buick invites comparison on every point, price included. But, in comparing prices, be sure you add up the cost of "accessories" on other cars that are standard equipment on Buick. You'll be surprised

Below is a partial list of features on the Buick Special, which usually cost extra on other cars:

- 1 Oil filter
- 2 Dual air trumpet horns
- 3 Dual windshield wipers, with adjustable speed
- 4 Automatic cigar lighter
- 5 Dual sun visors
- 6 Fore-n-Aft Flash-Way direction signal, including front fender lamps
- 7 Dual tail lamps, with high-intensity reflectors
- 8 Three guards on each bumper

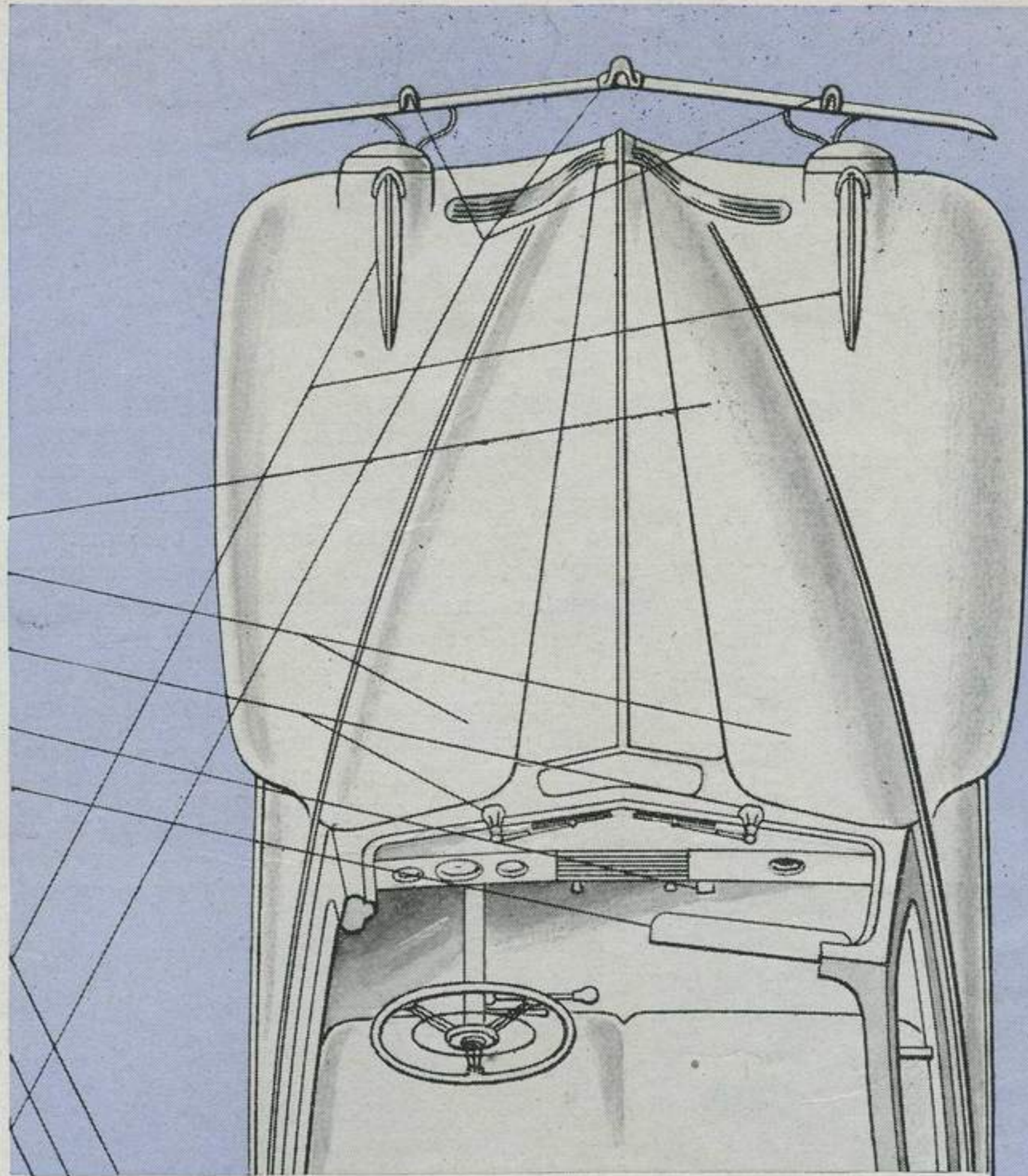

We believe in putting our "EXTRAS"
into the *Car* instead of into the *Price*

YOU'VE probably noticed that Buick advertising steers clear of the term "de luxe equipment."

We do that because we feel that most "de luxe" equipment isn't luxury equipment at all—it's *necessary* equipment that most buyers want. And, since most buyers want it, we think it should be included in the advertised price of the car.

Direction signal lights, dual windshield wipers and tail lamps, for example, are no luxury. You aren't completely safe without them.

Oil filters are no luxury. Modern engines demand them for lasting economy.

Nor are bumper guards an extravagance—not with traffic and parking conditions as they are today.

Buick's "extra-value" list is long—and it's something to remember when you're in the market for a new car. Before you take much stock in the advertised prices of any car, find out how much extra they would cost with the "de luxe" necessities.

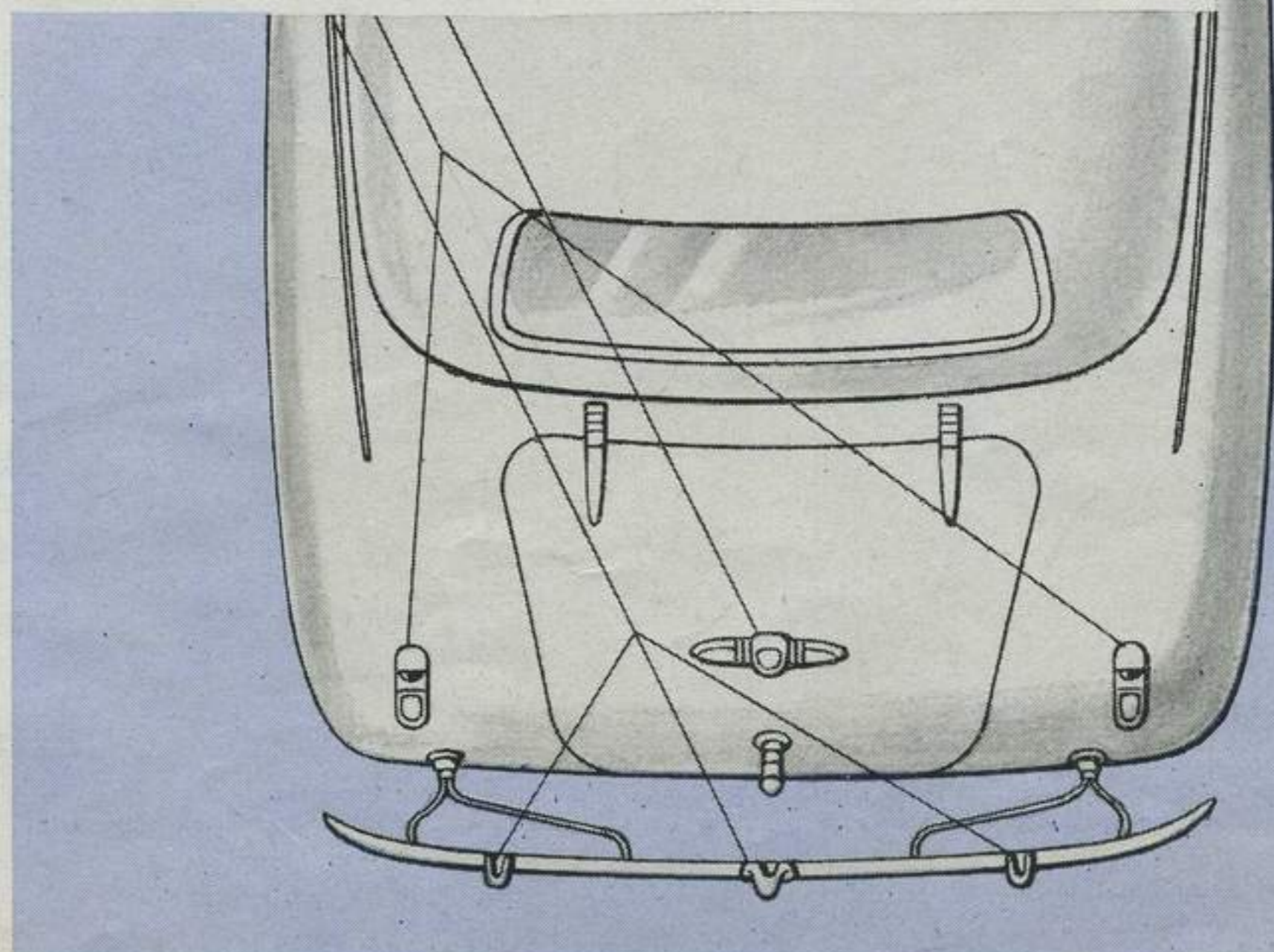

They **Wanted** to build it as good as it is

After engineers have made their discoveries, after modern machines have worked new wonders in steel, it takes loyal, seasoned craftsmen to give Buick the lasting goodness it's famous for. These veterans are just as proud of the cars they build as you will be

WHEN you grow up gradually, operating at the same old stand for a thirty-six-year period, you can choose your craftsmen with care. You can surround yourself with men who become a vital part of the business.

That's the Buick story. Over forty per cent of the men at Buick are over forty years old; about a third of that number are over fifty. Fact is, more than a few Buick men have passed the seventy mark and are still going strong. These are the kind of craftsmen who put an extra measure of goodness into every car they build; because

they don't have to be *told* to do the finest work in the industry—they *want* to do it. It's a matter of personal pride with them.

Carefully selected young men, who annually take their places in this organization, naturally get to feeling the same way about skilled workmanship. The result is that Buick, the largest fine car factory in the world, is still noted for its personalized craftsmanship in every car.

When you buy a new Buick, this personalized craftsmanship is one of your important extra dividends.



Colin McLeod has been with Buick for thirty-one of his fifty-seven years. He puts finishing touches on the main bearings

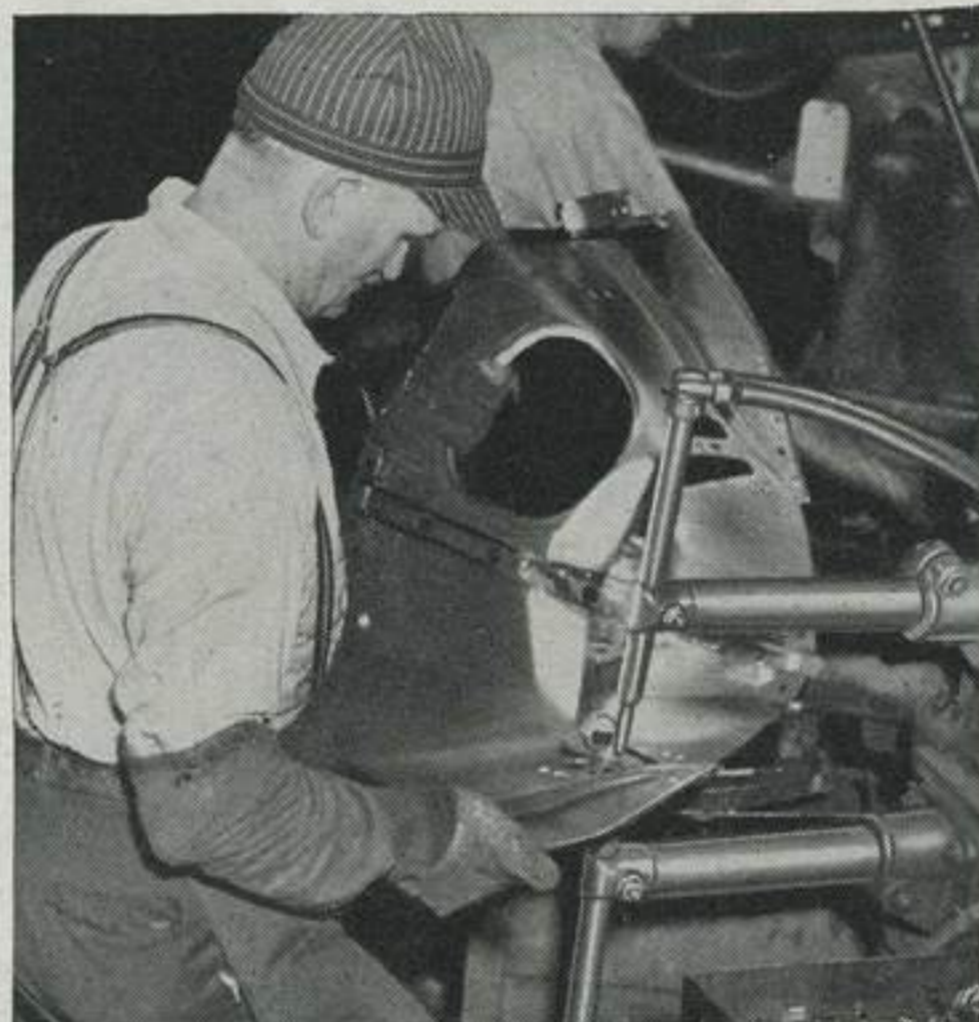

Frederick S. Hennessy, fifty-two years old, has been making his share of Buicks for seventeen years. He's an expert spot welder



Harry Pearson, Buick man for fifteen years, checks the lead on a counter gear, using one of Buick's modern precision machines



Claude C. Baldwin, with nineteen years of Buick service to his credit, is a skilled tool-maker. He is shown at a slotter machine

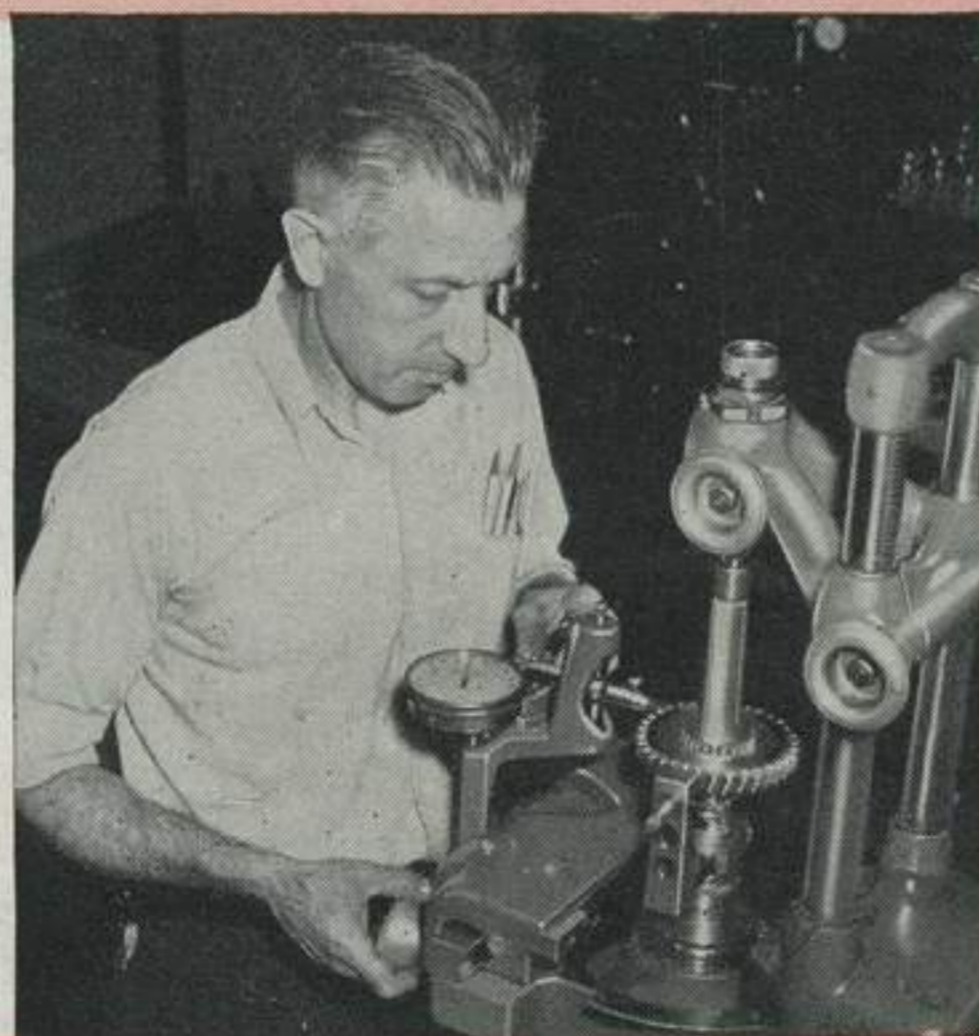

Ralph J. Hallitt checks the pressure angle of a gear tooth. A Buick foreman, he has twenty-two years of service behind him

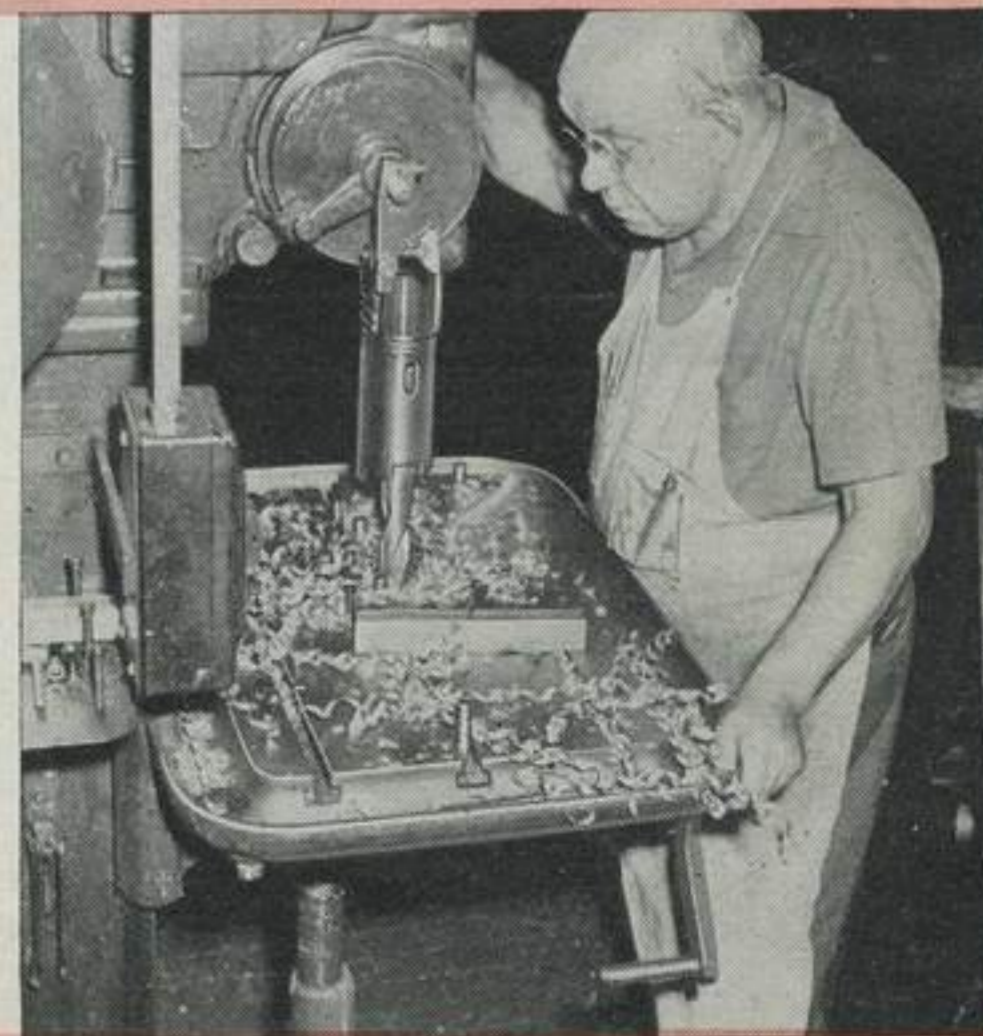

Walter G. Hill, expert diemaker, started with Buick when he was fifty years old. He's been busy there for thirteen years



ONLY YOU

*...and a new Buick...
can write this chapter*

By W. F. HUFSTADER

Vice-President and General Sales Manager, Buick Motor Division

Now that you have reached this page in the announcement number of *The Buick Magazine*, I think it is safe to assume that you are already sharing some of our enthusiasm for the 1940 Buicks.

Our president, Mr. Curtice, in his article, has ably told you about the background of these cars and the enthusiasm, the hard work, and the grueling testing that went into their building.

Mr. Chayne, our chief engineer, has told you about the mechanical developments that make the new Buicks so smooth, so powerful, so dependable.

You have seen pictures of the complete new line and of the appointments and conveniences that make their interiors so luxurious. No words of mine can add to the fine impressions you have already received. But one big privilege does remain for me. I can invite you to go for a ride in one of these new Buicks.

I wish it were possible to extend this invitation to you personally. But I can assure you that if you visit your Buick dealer, or call him, you will receive the same cordial welcome as you would here at Buick headquarters.

No matter how carefully you have read about the 1940 Buicks, nor how closely you have scrutinized the pictures,

there is a further thrill waiting for you when you actually go for a ride in one of these big, new beauties.

Please don't hesitate to accept this invitation simply because you are not thinking of buying a new car at this time. Whether or not you claim one of the new Buicks for your own at an early date, we want you to have the unforgettable impressions that only a ride can give you.

We want you to test these new Buicks as only you can test them. Try them out on the hills and straightaways in your own region. Swing off the smooth highway and skim over some of the byways that are noted for tough going—washboard roads, gravel, sand, sharp curves, steep grades.

You'll find that the new Buick conquers these tough spots with the same blithe ease with which it eats up the miles on smooth pavement. And you'll come back from your ride with a glowing enthusiasm that will more than repay us for extending the invitation.

That ride, with all its thrills and revelations, is really the final chapter in this announcement number—a chapter only you—and a new Buick—can write.

Begin it just as soon as ever you can, and take with you our heartfelt gratitude for your loyalty to Buick that has made possible the great developments of 1940.

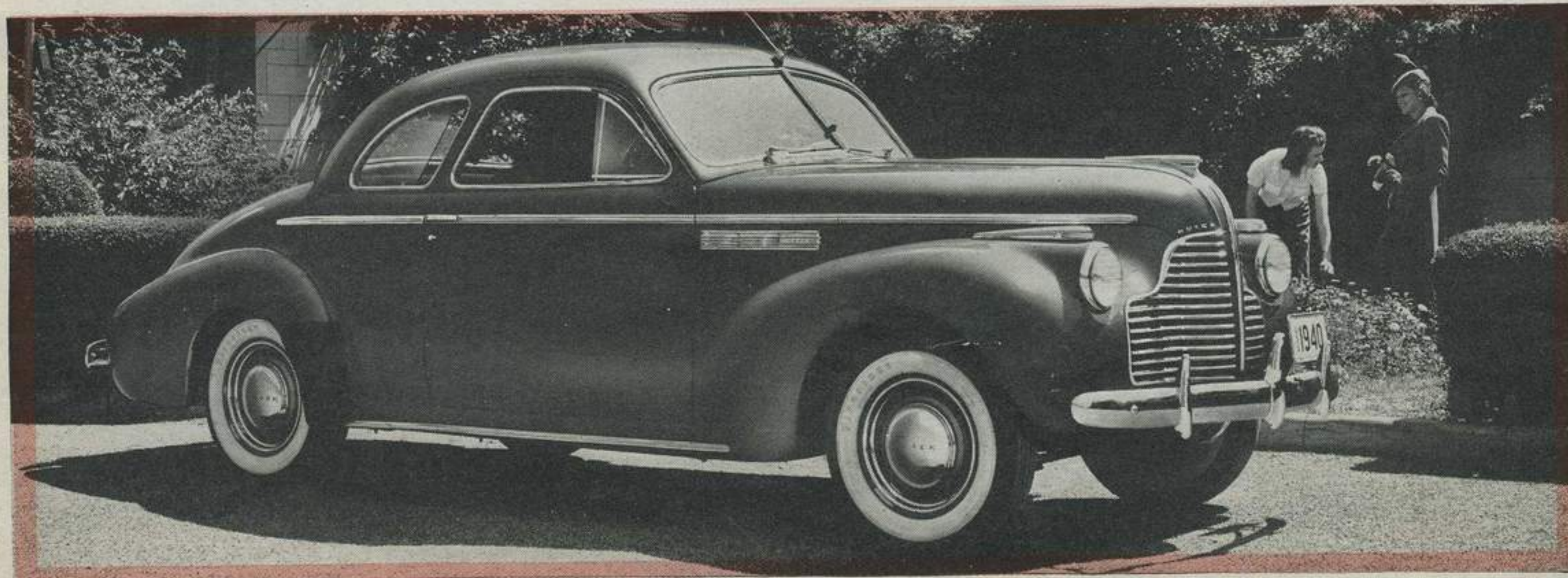

Postage
will be paid
by
Addressee

No
Postage Stamp
necessary
if mailed in the
United States

BUSINESS REPLY CARD
First Class Permit No. 14, Sec. 510, P. L. & R., Detroit, Michigan



MR. W. F. HUFSTADER
THE BUICK MAGAZINE
PUBLICATION OFFICES
818 HANCOCK AVENUE WEST
DETROIT, MICHIGAN

Will you take a ride?

Your Buick dealer invites you to take a ride in one of the new Buicks for 1940, at no obligation to you. Simply fill out and mail this reply card and he will make the arrangements.

Keep posted on values

Whether or not you intend to buy a new car this year, your Buick dealer urges you to inspect the new line of Buicks for 1940. He believes you want to keep posted on how much automobile your money will buy.

I'll be glad to accept your invitation to a ride in one of the new Buicks for 1940. I want to keep posted on automotive values, and I understand this does not place me under any obligation.

- You may arrange for me to ride in, and drive, one of the new Buicks.
- Please send me the 1940 Buick catalog.
- I'd like to have an appraisal on my present car, without obligation.

Make.....Year.....Model.....

Name.....

Street.....

City.....State.....Phone.....

Dealer's name.....

(His name appears on the back cover of "The Buick Magazine")

25
25
You're the **FIRST** to **HEAR**
about the **NEW BUICKS**



Be the First **TO SEE AND DRIVE ONE!**

We've sent you this special advance information on the new Buicks to give you a chance to inspect these cars and drive one before the season's early rush begins.

At this first showing, to which a limited number of people have been invited, you can get the complete Buick story for 1940 without any bothersome waiting around. You can discuss these new cars carefully and give them a thorough examination without any interruption.

Your visit is expected, and we've arranged to take you for a drive or place a new Buick at your disposal.

If a visit to our showroom isn't convenient for you right now, simply give us a ring and we'll have a new Buick at your front door without delay.

In either case, we look forward to showing you the greatest line of cars we've ever offered—and please understand that your inspection of them won't place you under the slightest obligation.



WELTY-BUICK COMPANY

Telephone: Wheeling 884
Wheeling, West Virginia

L-2398