

CHEVROLET

1955

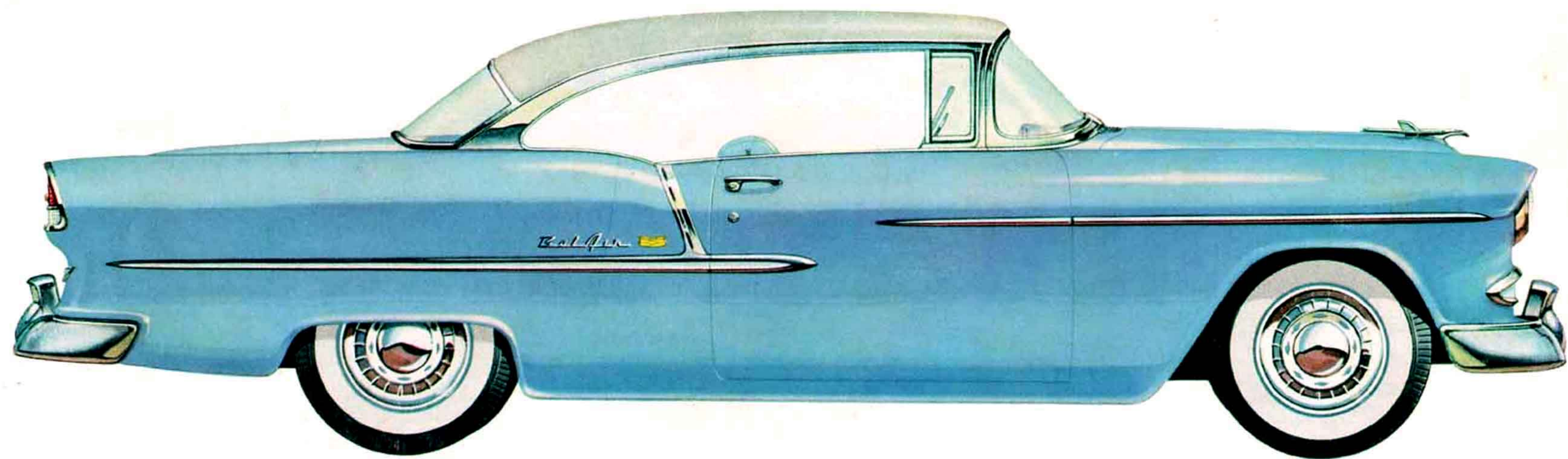

New Look! New Life (V8 OR 6)! New Everything!

LOW-AND BEHOLD! HERE ARE THE NEW CHEVROLETS!

FOUR-DOOR SEDANS

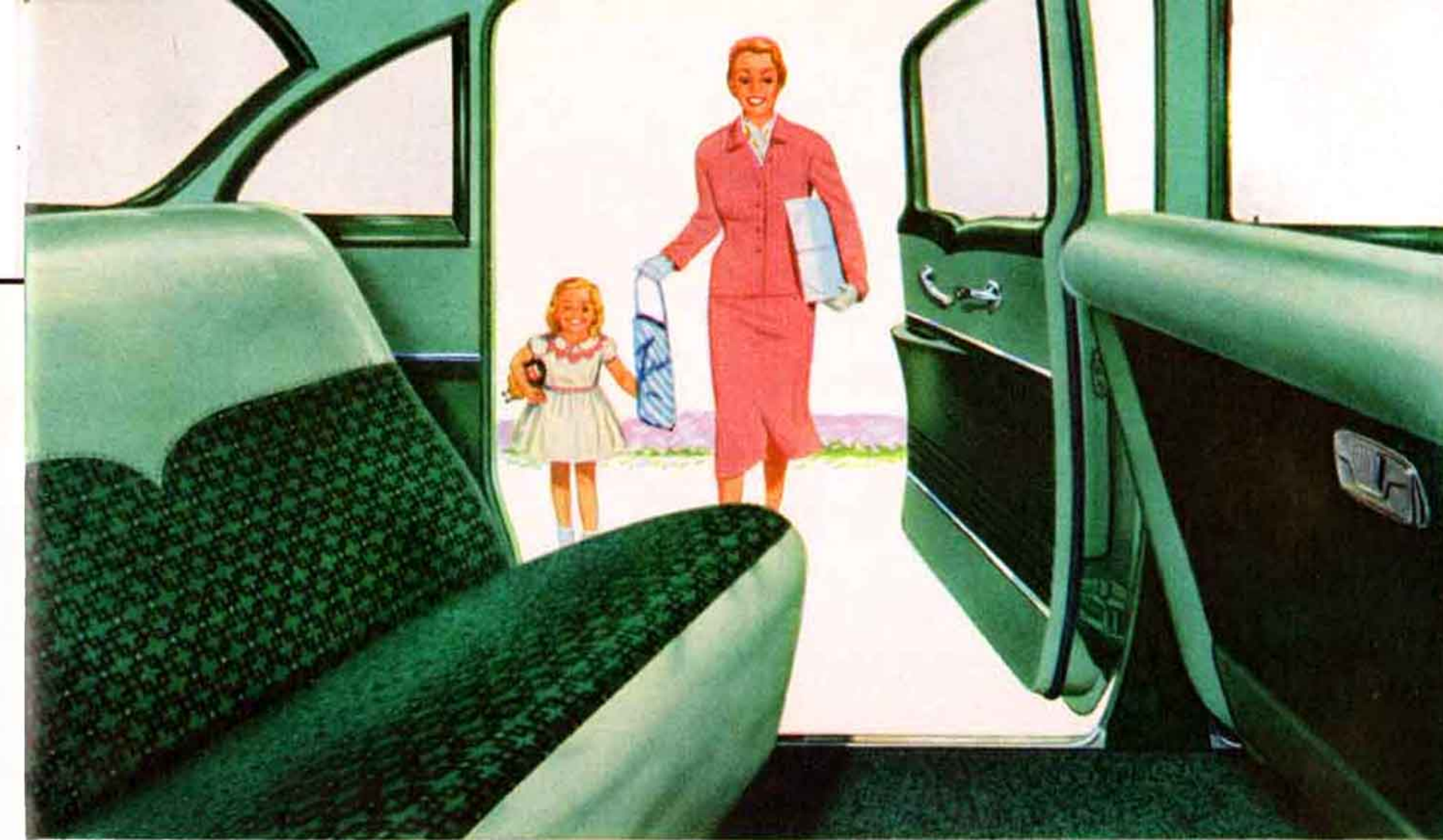

THE BEL AIR 4-DOOR SEDAN

Here's Chevrolet's new "show car" styling at its beautiful best. The new Bel Air 4-Door Sedan looks as young as you feel behind the wheel! Wider and longer looking, and much, much lower—its crisp lines enhanced by tasteful chrome accents that distinguish the luxurious Bel Air models.

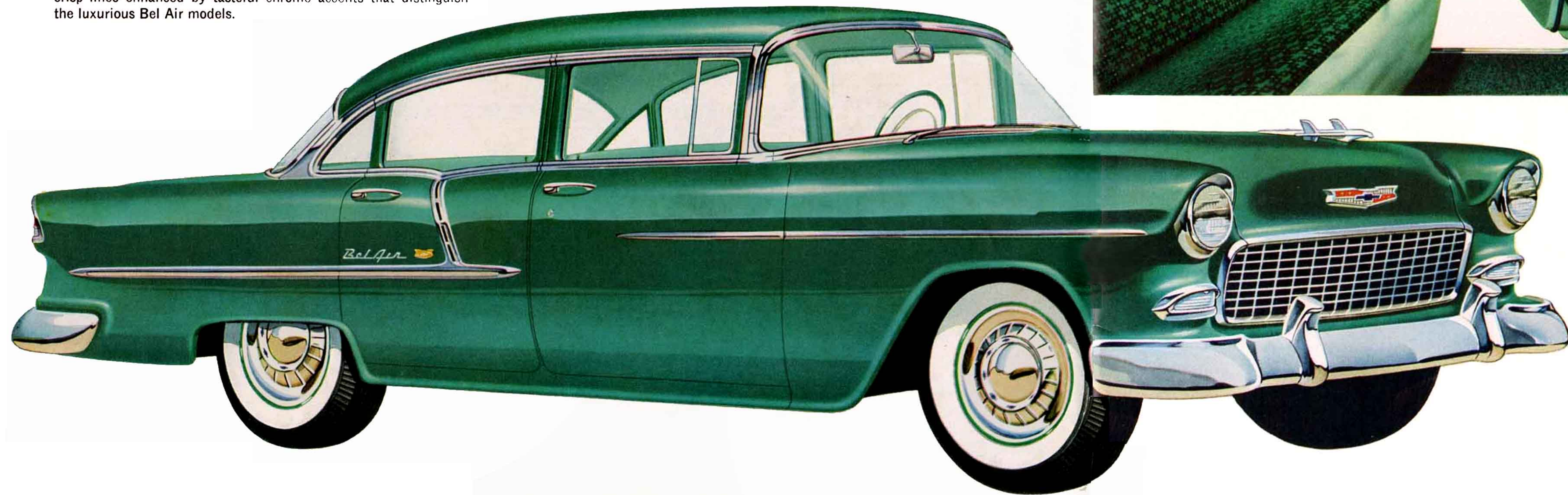

THE BEL AIR 4-DOOR SEDAN INTERIOR

Try this for sighs! Looks roomy—and it is. The new Chevrolet gives you more room for hats, hips and shoulders. Looks luxurious—and it's that, too. New Bel Air fabrics and fittings have a look of custom quality that you'll find only in much higher-priced cars. Color-keyed with the exterior, of course. And what colors they are!



THE "TWO-TEN" 4-DOOR SEDAN



THE "ONE-FIFTY" 4-DOOR SEDAN



THE BEL AIR 2-DOOR SEDAN



THE "ONE-FIFTY" 2-DOOR SEDAN



THE "ONE-FIFTY" UTILITY SEDAN

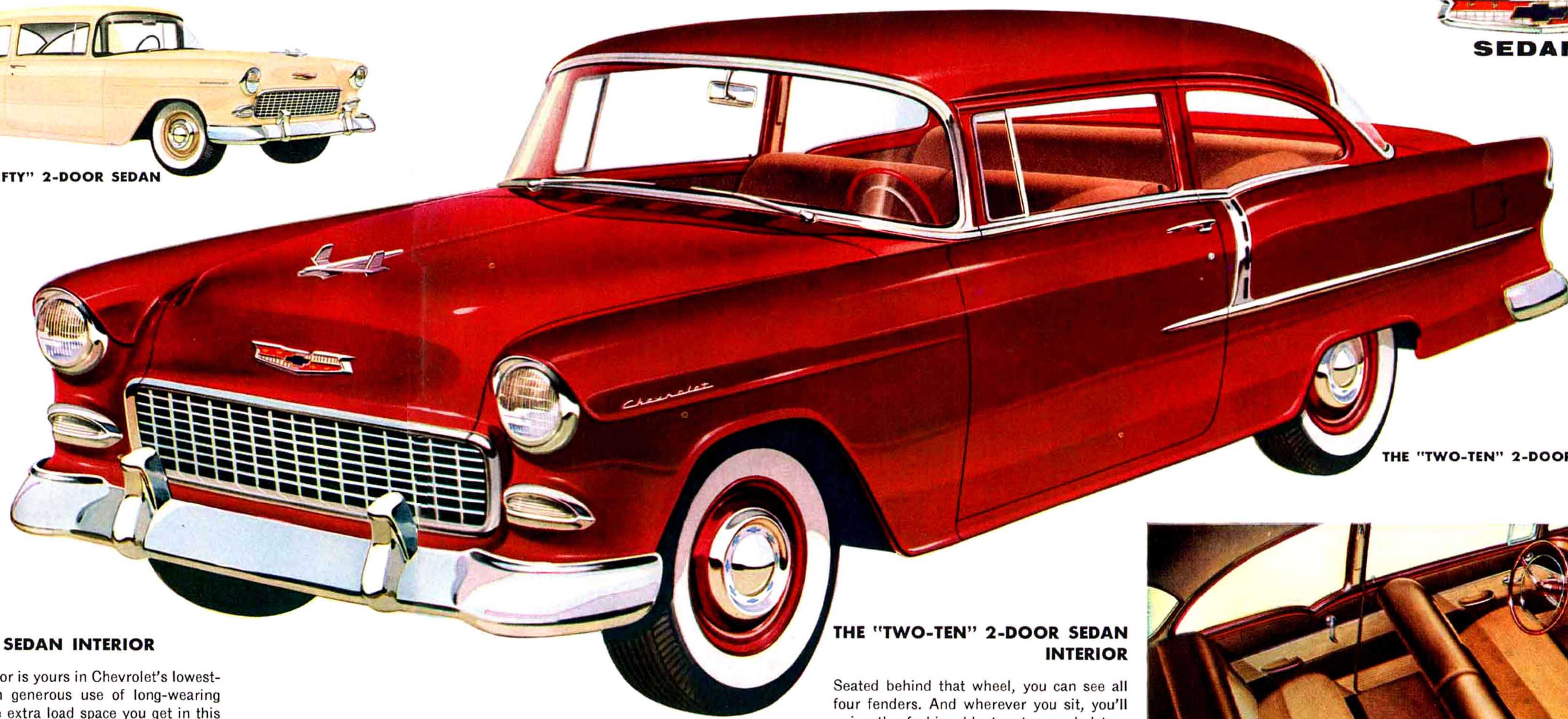

THE "TWO-TEN" 2-DOOR SEDAN

**TWO-DOOR
SEDANS**



THE "ONE-FIFTY" UTILITY SEDAN INTERIOR

That's right! This handsome interior is yours in Chevrolet's lowest-priced series. Practical, too, with generous use of long-wearing vinyl trim. And just look at all the extra load space you get in this "One-Fifty" Utility Sedan. The entire rear compartment can be used for hauling cargo—and the floor is raised to make loading and unloading easier.

THE "TWO-TEN" 2-DOOR SEDAN INTERIOR

Seated behind that wheel, you can see all four fenders. And wherever you sit, you'll enjoy the fashionable two-tone upholstery and smart new appointments of this beautifully color-keyed interior. Imagine—all this glamour in a sound and sensible family car!

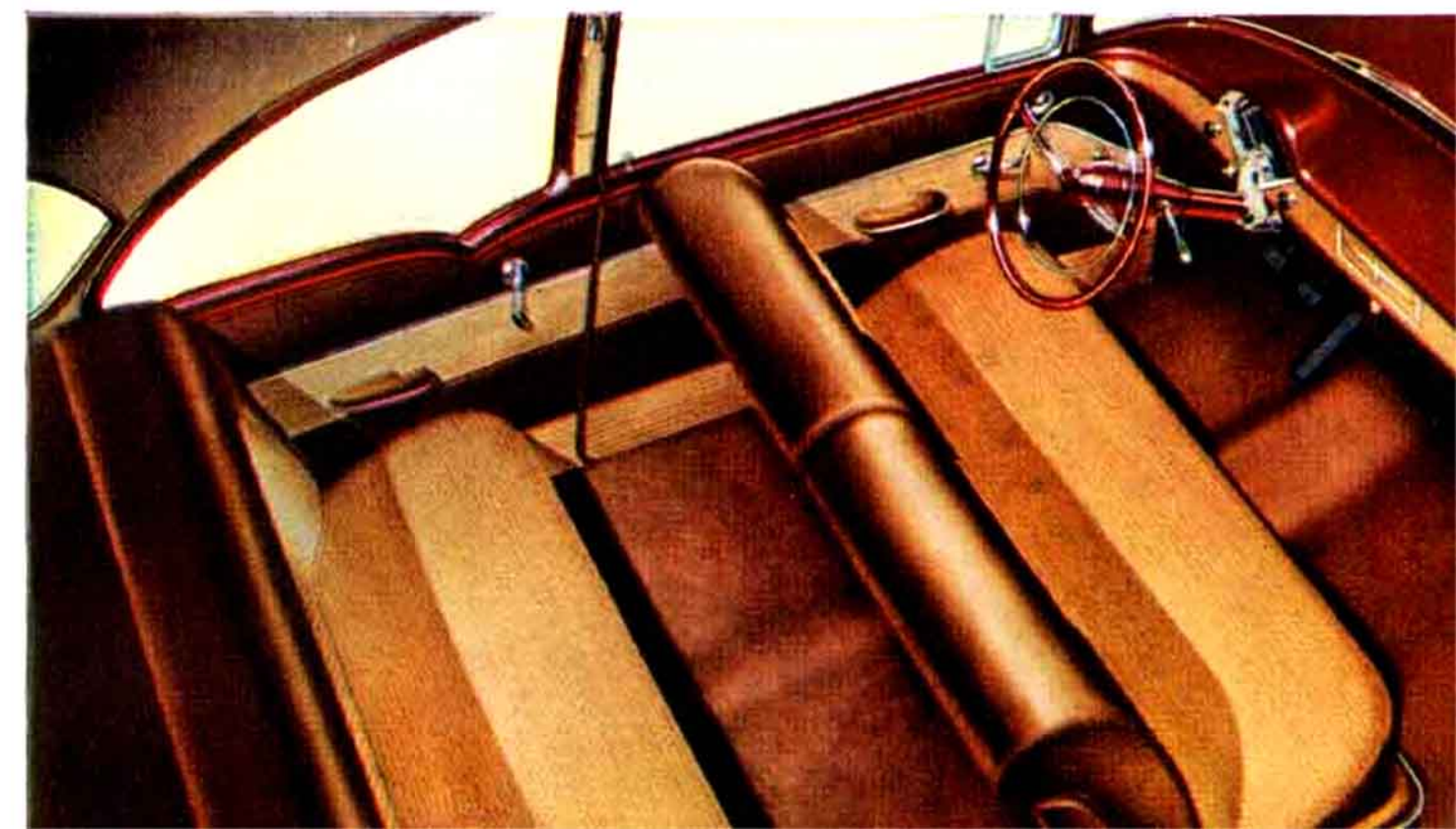

**SPORT
MODELS**

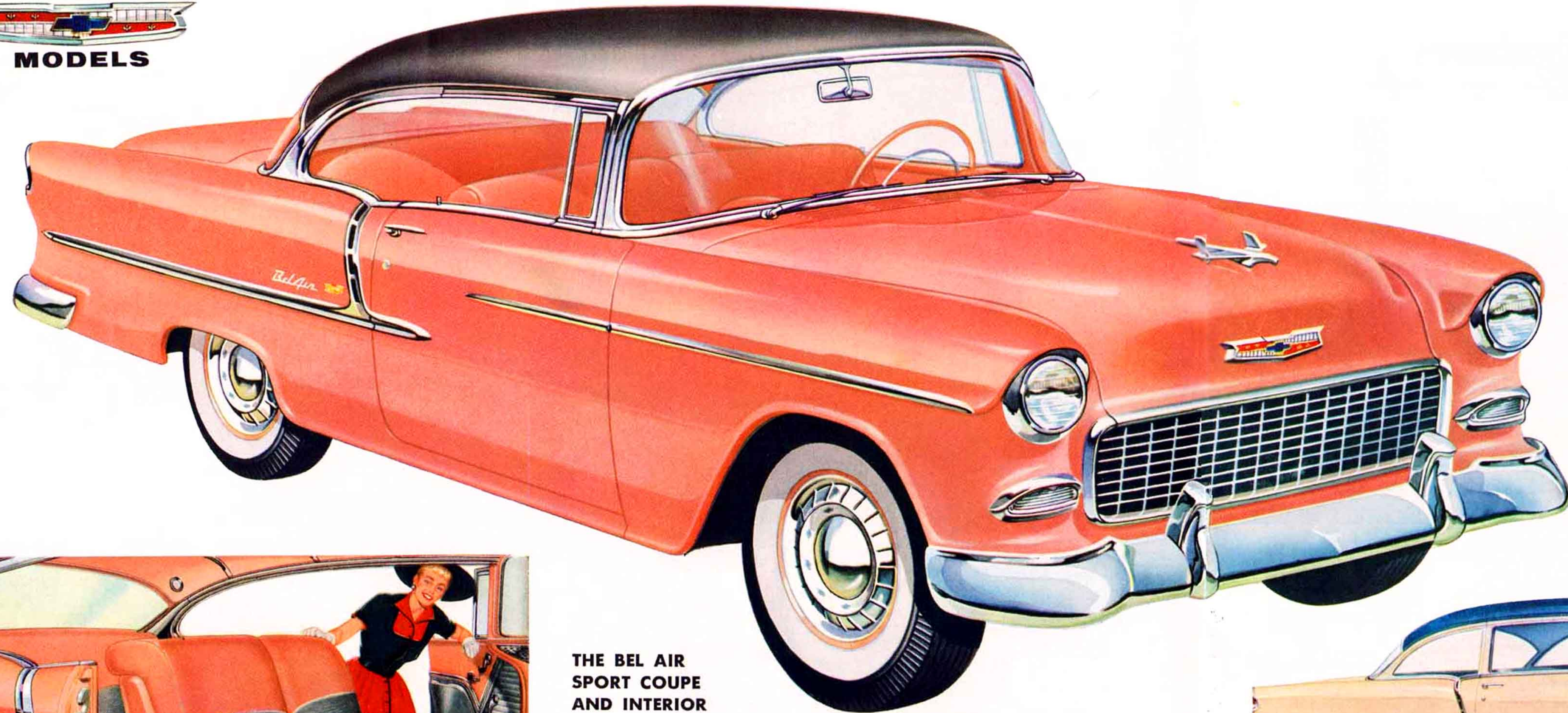

**THE BEL AIR
SPORT COUPE
AND INTERIOR**

It's got glamour—and plenty to go with it! The new Bel Air Sport Coupe has a dashing, distinctive beauty all its own. And that goes for the interior, too. Smart straw-patterned cloth is combined with panels of rich looking vinyl in the luxurious two-tone interiors. And every inch is color-keyed to harmonize with breathtaking Bel Air exterior colors.

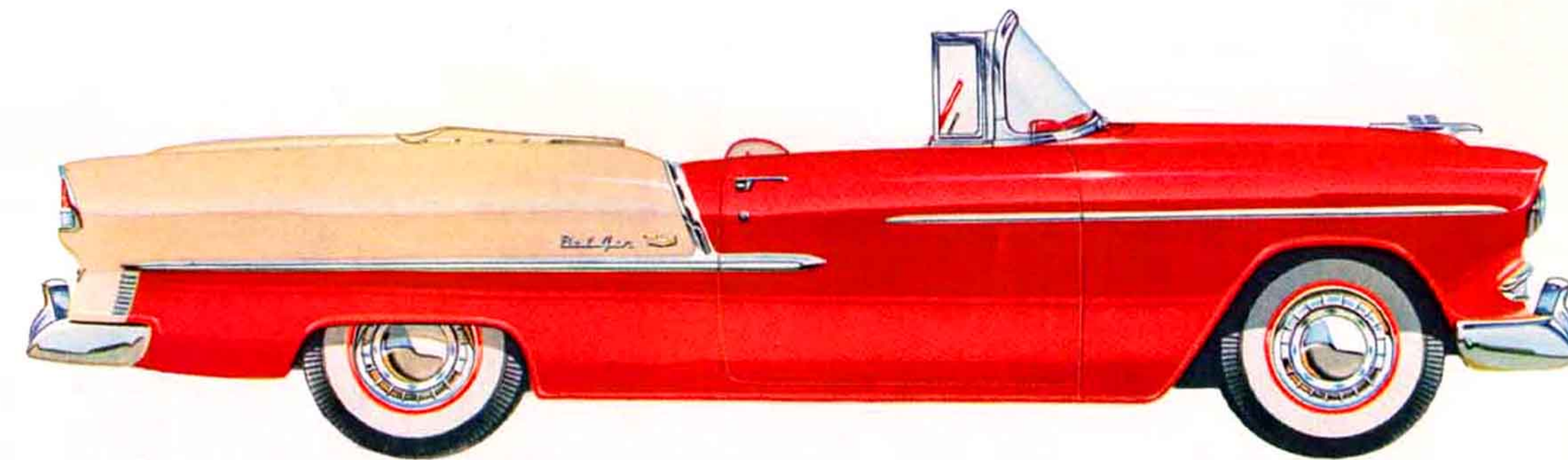

**THE BEL AIR
CONVERTIBLE**

If you go for convertibles, this you're going to love! Two-tone interiors are beautifully tailored in smart, durable vinyls. And they're completely color-keyed to harmonize with exteriors—even down to the thick carpets on the floor! The power-operated top also complements the exterior color of your choice.



**THE "TWO-TEN" DELRAY
CLUB COUPE
AND INTERIOR**

Here's the club coupe that gives you the style and roominess of a two-door sedan—plus a handsome interior that will stay handsome after plenty of hard use. The seats, sidewalls and even the roof lining are all of wonderful, washable vinyl. As shown in the picture below, the interiors are smartly fashioned in two-tone combinations to harmonize with a wide range of exterior colors.



STATION

WAGONS

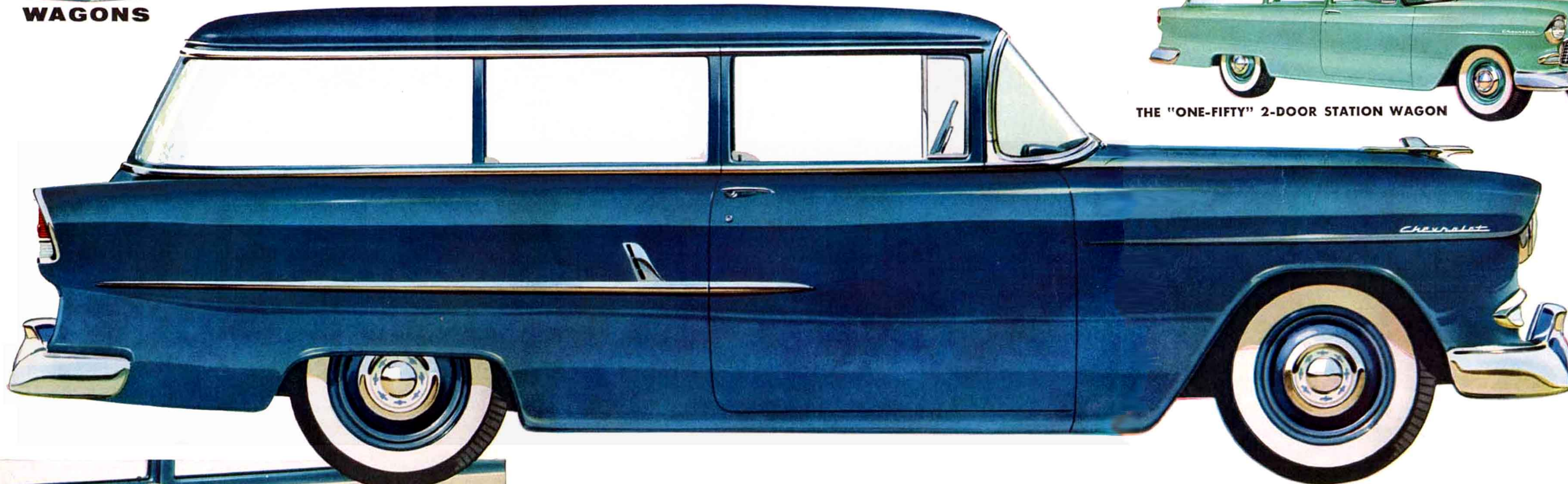

THE "ONE-FIFTY" 2-DOOR STATION WAGON



THE "TWO-TEN" 4-DOOR STATION WAGON



THE "TWO-TEN" 2-DOOR STATION WAGON

Chevrolet presents a whole new idea of station wagon usefulness and beauty for 1955! Who could ask for a handsomer car than this low (6 inches lower!) "Two-Ten" 2-Door Station Wagon! Notice how the side windows curve around at the rear, letting you "see through" the corners. Look at those long and graceful lines. Then take a peek inside (at left). Here's an all-vinyl interior that's as practical as it is beautiful. And it's beautifully color-keyed to go with whatever exterior you select. Seats six with room to spare—and there's more spare room with the rear seat folded.

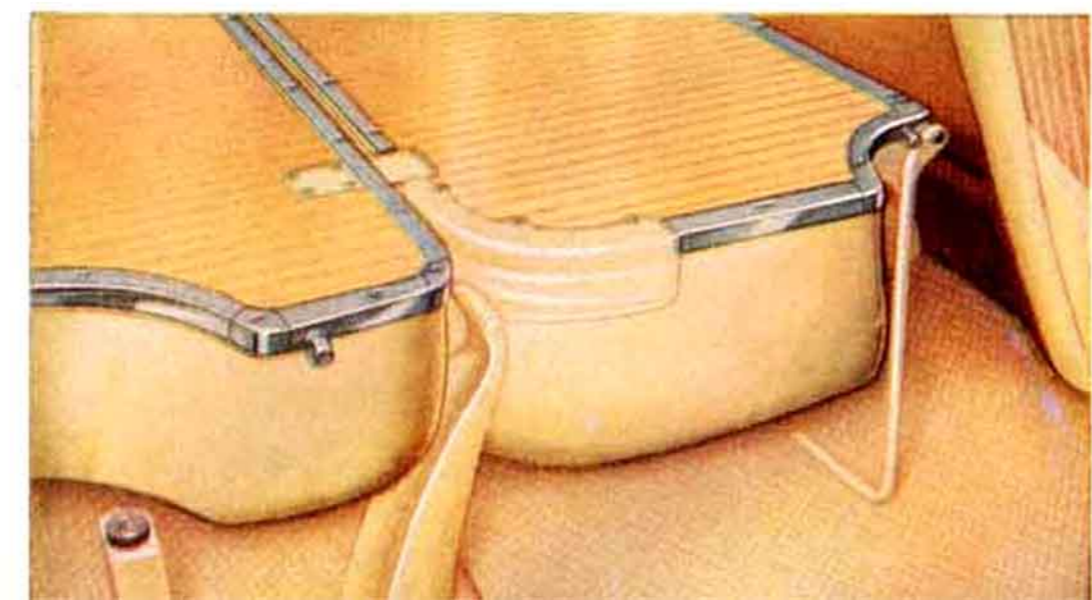

NEW FOLD-AWAY REAR SEAT

The rear seat in all 1955 Chevrolet station wagons folds completely flat to give you extra load space. Both the seat cushion and the back rest become part of the load platform when folded. This gives you a cargo floor that's almost 11 inches longer than in previous models!



THE BEL AIR 4-DOOR STATION WAGON

NEW SWEEP-SIGHT WINDSHIELD

It's the newest thing in style and sight! Chevrolet's Sweep-Sight Windshield curves gracefully around to vertical corner pillars, giving the driver a wider view of the road ahead. You get the very latest "look"—and the very best looking in Chevrolet for '55!

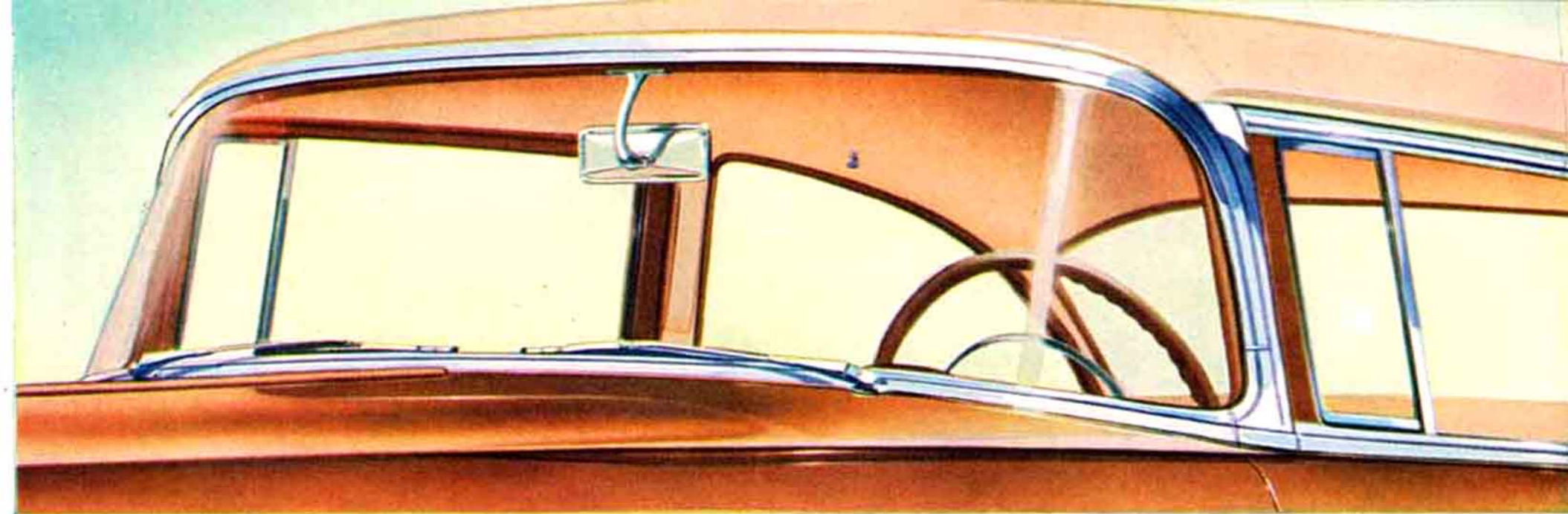

NEW SWING-TYPE PEDALS

Chevrolet's new Swing-Type brake and clutch pedals swing downward with a light pressure of your toe. They pivot at the top, leaving the floor free and clear. New accelerator has no push-rod through floor.



NEW DOOR HANDLE AND LOCK

Chevrolet's pushbutton door handle is now even handsomer and handier. The handle is slimmer and the pushbutton has been lowered for easier operation. The key lock is now located on the door itself, directly beneath the handle.

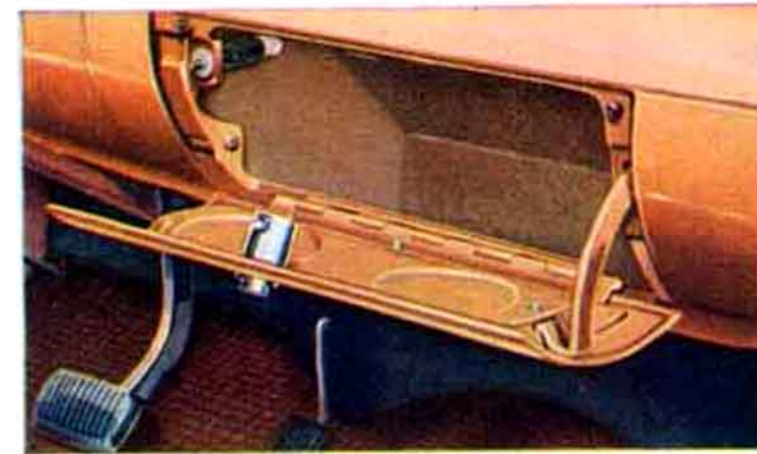

NEW CENTER GLOVE COMPARTMENT

Here's another new Chevrolet feature you'll go for! The glove compartment is in the center of the instrument panel, within easy reach of both driver and front-seat passengers. As you can see, it's plenty roomy, too.



NEW BALL-RACE STEERING

The new Chevrolet steers with ball-bearing ease! New Ball-Race Steering greatly reduces friction to give you greater handling ease than ever before. Also, steering is smoother, steadier.

NEW INSTRUMENT PANEL

There's an "airliner look" about Chevrolet's glamorous new instrument panel. Instruments are grouped to read at a glance. Red lights flash on to indicate low oil pressure or low generator charging rate. Ends of the panel curve around and blend beautifully into the doors.



Here it is: THE NEW CHEVROLET V8 ENGINE!

Here's the valve-in-head V8 as only the valve-in-head leader can build it. And here are some of the wonderful things it brings you: 162 horsepower with an 8-to-1 ultra-high compression ratio! Highly efficient oversquare design, which means less piston travel . . . less friction wear! Exceptionally high horsepower per pound! The great new Chevrolet V8 delivers brilliant performance, surprisingly high gas mileage, and extra long life.

Extra! The new Plus-Power Package boosts Chevrolet's V8 horsepower to 180 . . . brings you even more exciting performance! Optional at extra cost on V8 models.

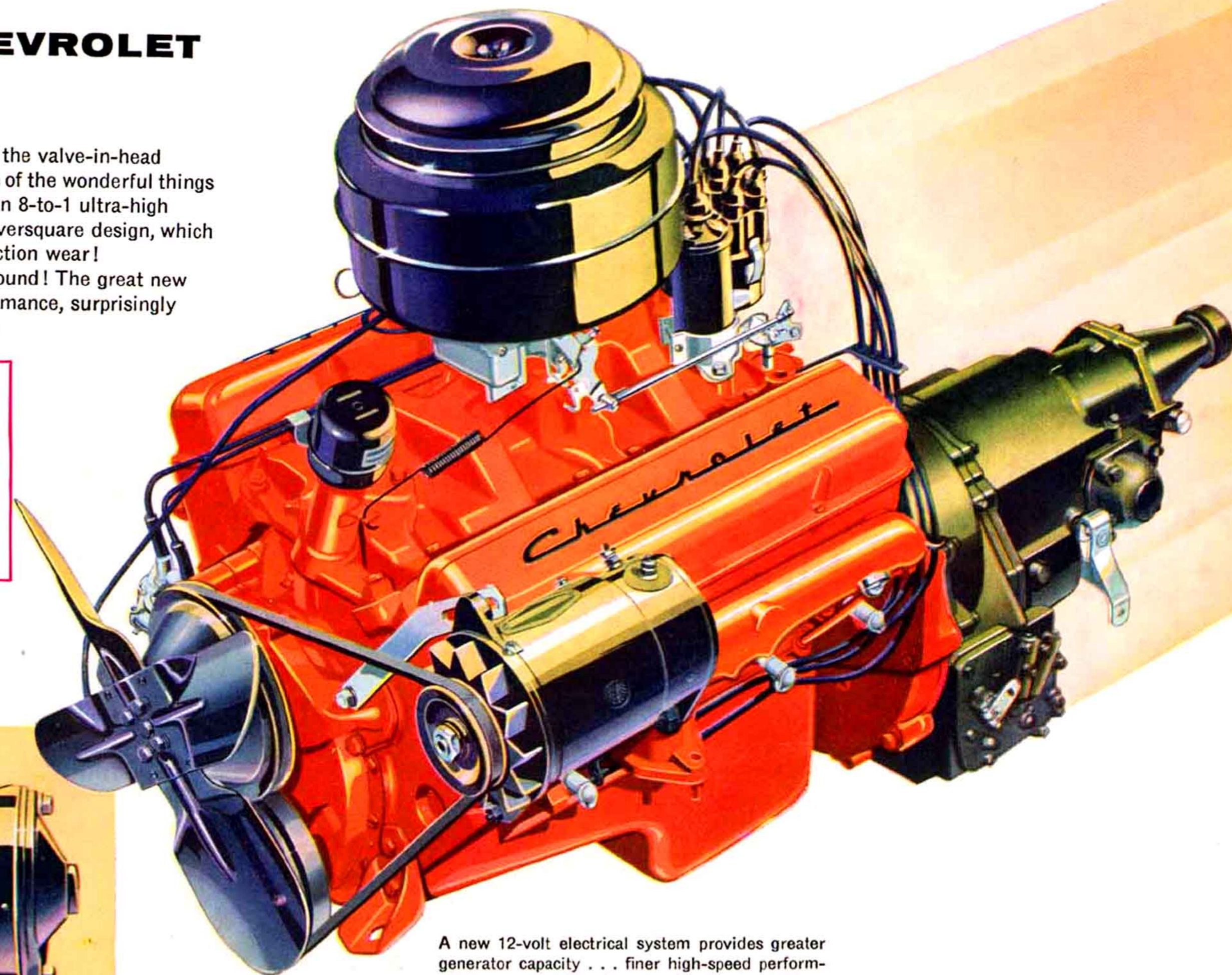

NEW 12-VOLT ELECTRICAL SYSTEM

A new 12-volt electrical system provides greater generator capacity . . . finer high-speed performance . . . more efficient battery charging . . . quicker, easier cold-weather starting! You get this engineering advance with all three 1955 Chevrolet engines!

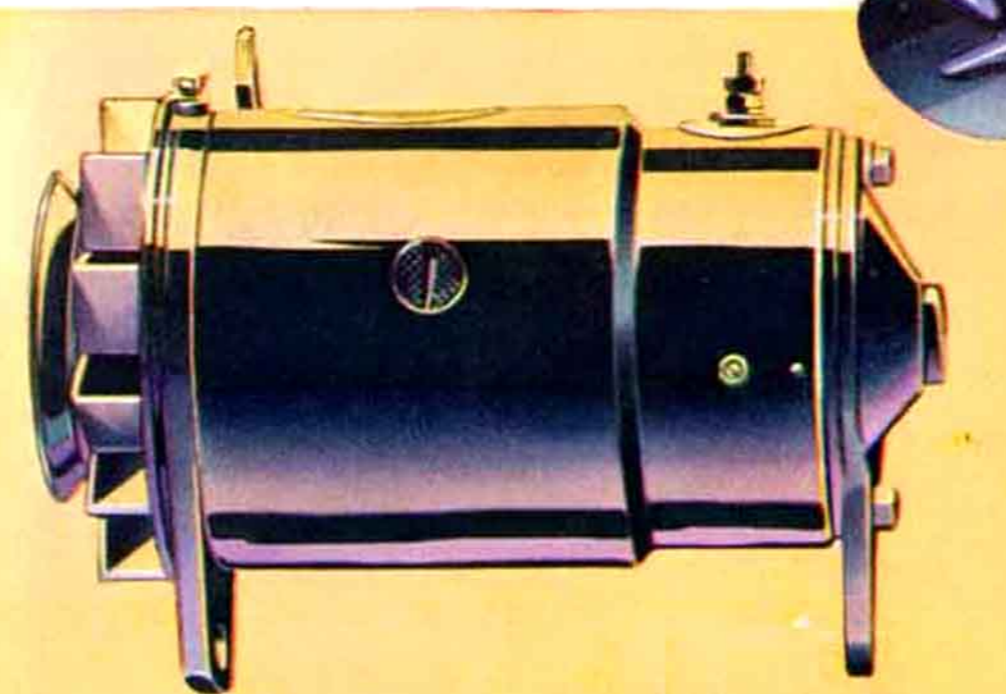

CHEVROLET PRESENTS TWO NEW SIXES!

THE NEW 136-H.P. SIX

Here's a brand-new valve-in-head six for Powerglide driving. It delivers a full 136 horsepower with a 7.5-to-1 compression ratio. And just look at some of the new advances it brings you—new vibration-smothering four-point suspension . . . new, more efficient cooling and lubrication systems. It's the smoothest, most powerful, finest performing passenger-car six the valve-in-head leader ever built!

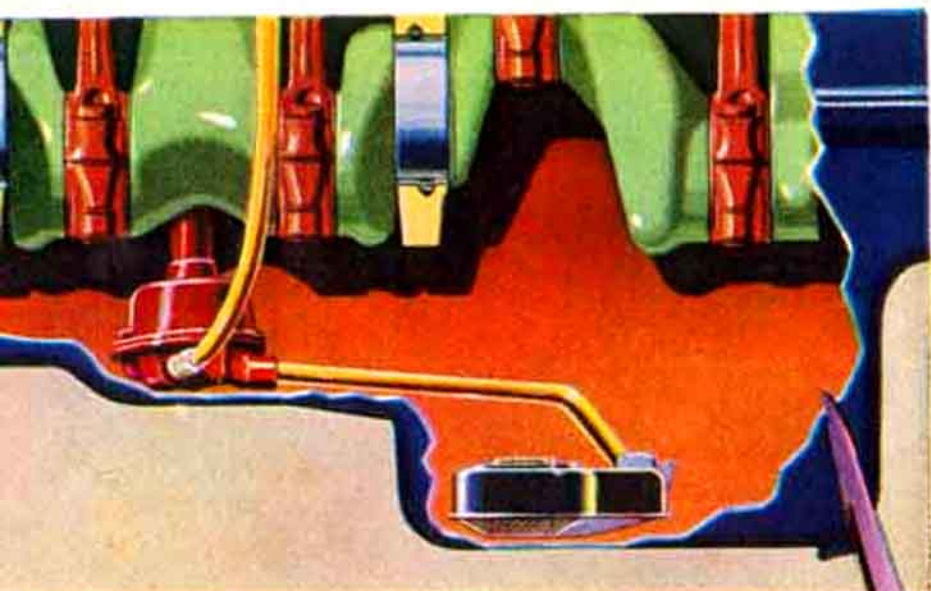

NEW FLOATING OIL INTAKE

This is another new advance offered by all three new Chevrolet engines. The screened intake of the oil pump is designed to float just beneath the surface of the oil in the crankcase, avoiding the froth at the top and the sediment at the bottom. Result—cleaner, more constant oil supply for better lubrication.

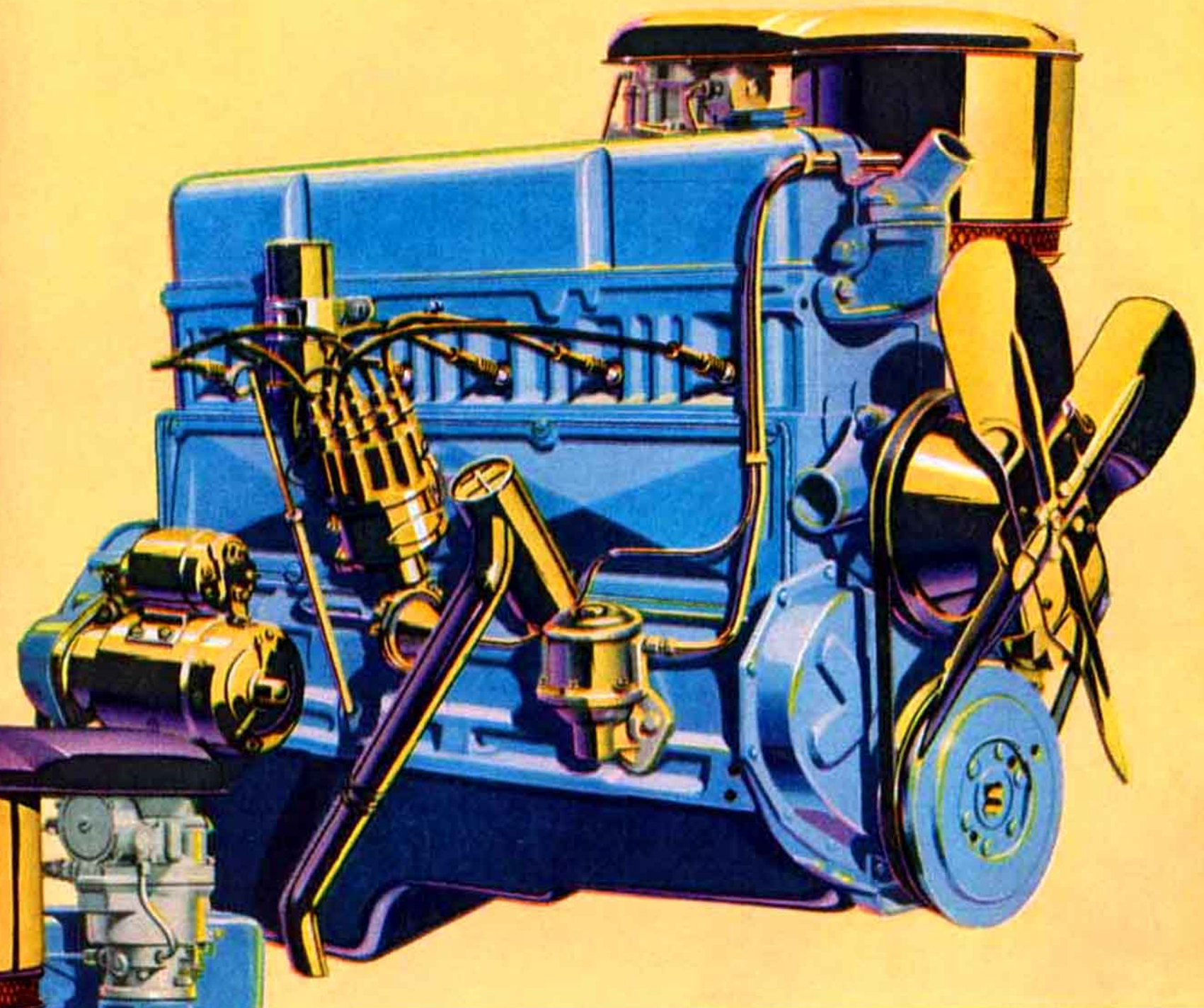
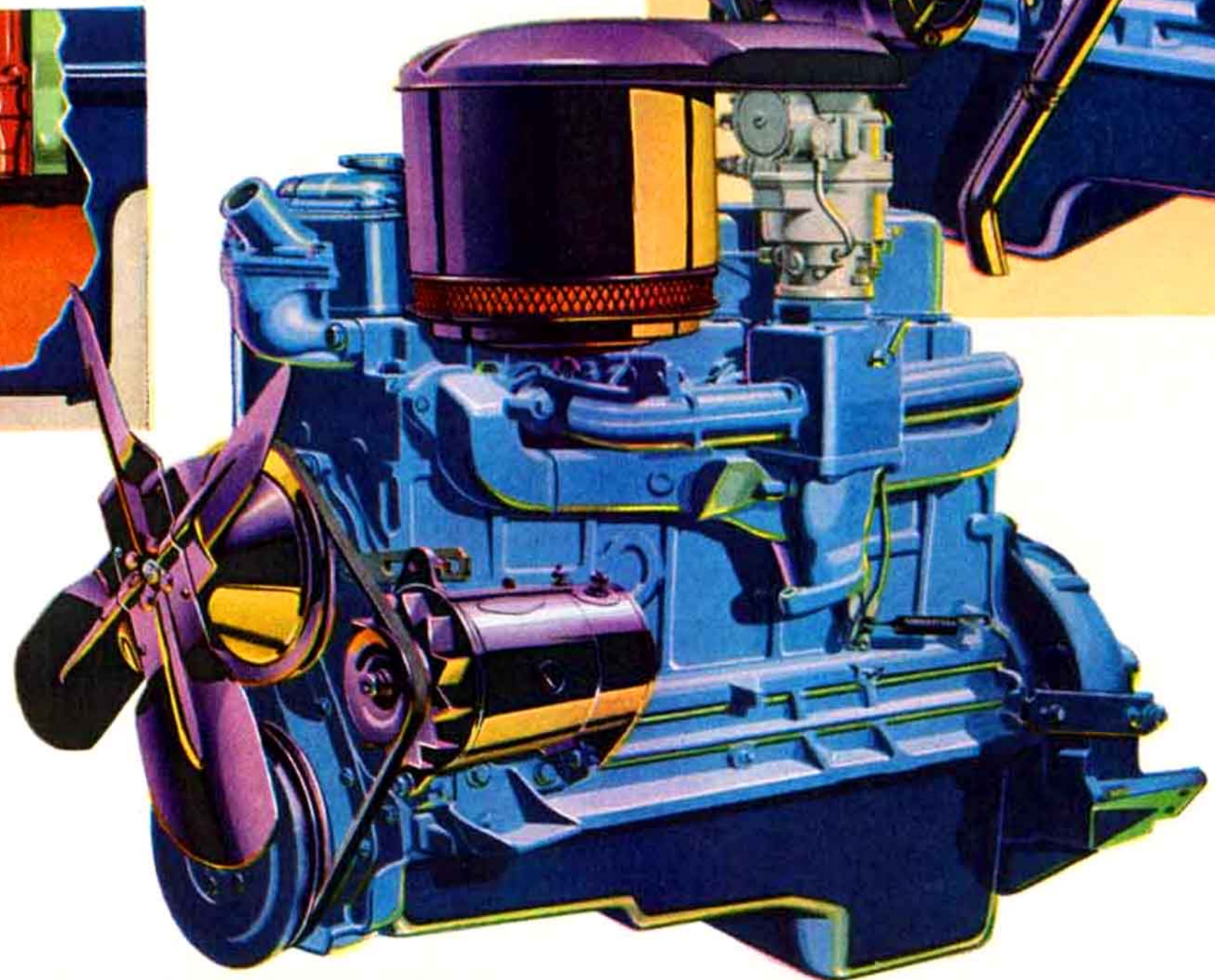

THE NEW 123-H.P. SIX

This great new Chevrolet six is teamed with either the new heavy-duty Synchro-Mesh transmission or the new Touch-Down Overdrive. It delivers 123 horsepower with a compression ratio of 7.5 to 1 . . . brings you the same new engineering advances as the new Powerglide six (above). This new 123-h.p. six gives you power to spare, fine all-round performance and the kind of gas economy that adds up to big savings in a hurry!

THE BIGGEST POWER-DRIVE CHOICE IN CHEVROLET HISTORY!

In the new Chevrolet you have your choice of three great valve-in-head engines, including the new V8—and your choice of three advanced drives, including the new Touch-Down Overdrive. All in all, you can select from six different power-drive combinations (as shown in the table at right)—the biggest choice in Chevrolet history! You get power as you like it in Chevrolet for '55!

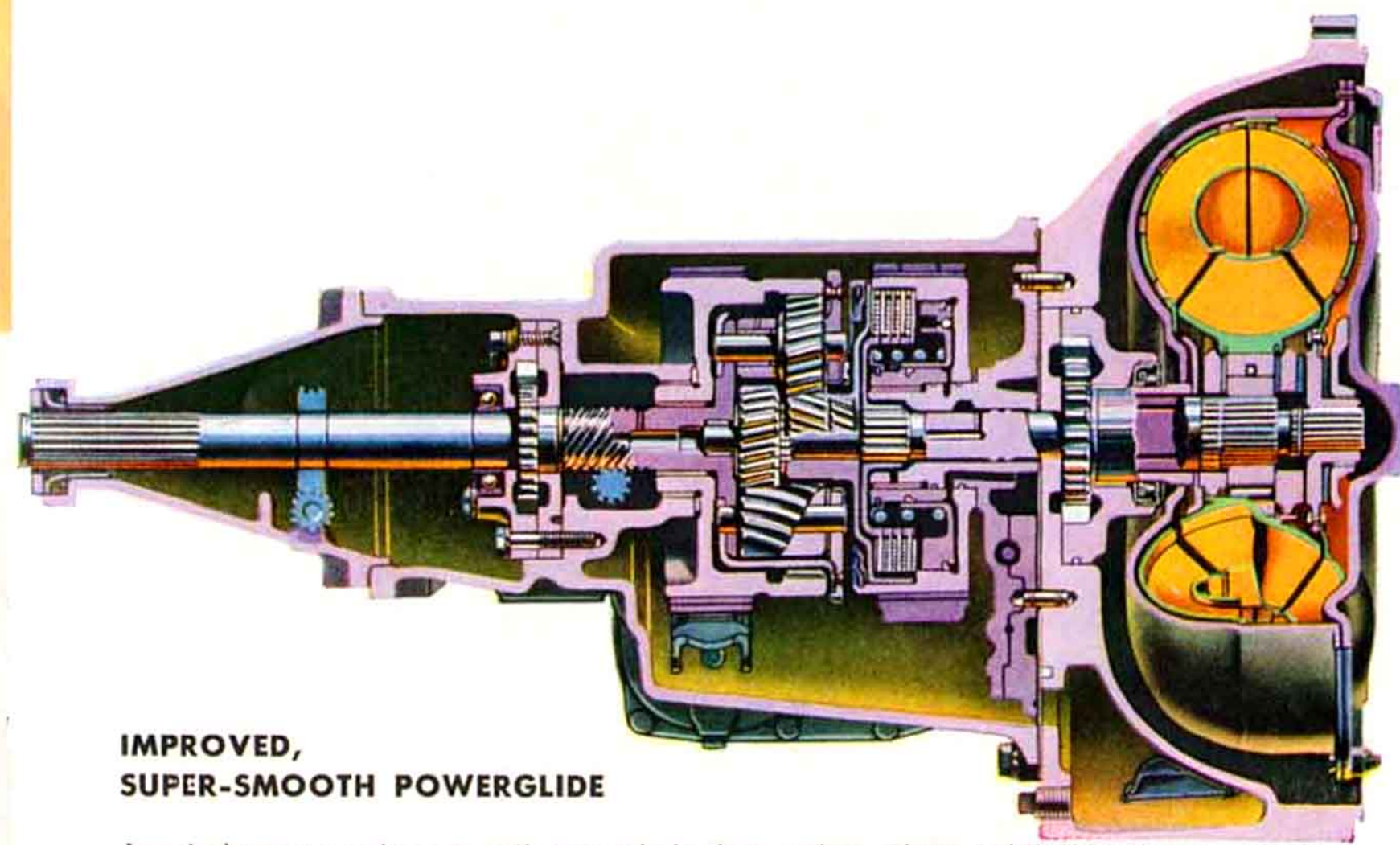

IMPROVED, SUPER-SMOOTH POWERGLIDE

America's most popular automatic transmission is smoother, quieter and thrifter than ever for '55! New engineering advances keep Powerglide's automatic shifts from low to cruising range a smooth, silent secret. You move away from a standing start in an unbroken stride of power. And Powerglide now brings you even greater durability. Teamed with the EconoMiser axle and either the new 136-h.p. six or the great new V8, it's optional on all models at extra cost.

TAKE YOUR CHOICE OF 6 NEW POWER TEAMS

- | | | | | | |
|---|---|---|-----------------------------------|---|------------------------------------|
| 1 | 123 h.p. SIX
with Standard
Transmission | 2 | 123 h.p. SIX
with
OVERDRIVE | 3 | 136 h.p. SIX
with
POWERGLIDE |
| 4 | 162 h.p. V8
with Standard
Transmission | 5 | 162 h.p. V8
with
OVERDRIVE | 6 | 162 h.p. V8
with
POWERGLIDE |

Both Overdrive and Powerglide Power Teams optional at extra cost.

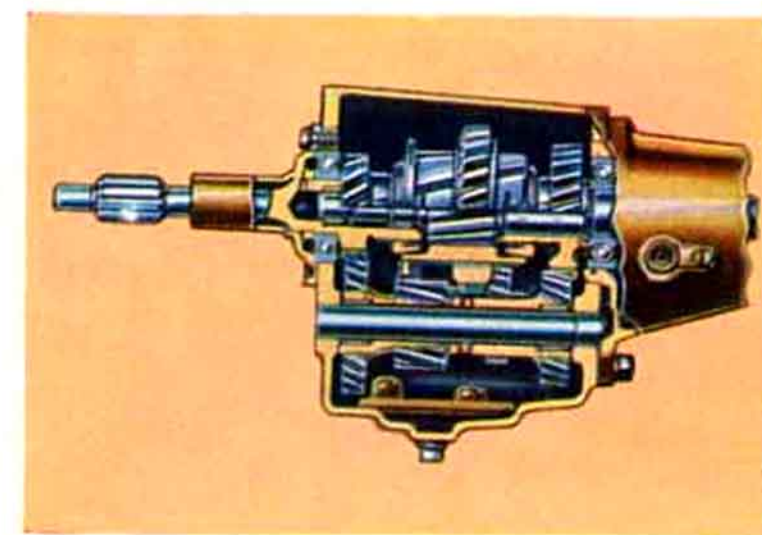

NEW HEAVY-DUTY SYNCHRO-MESH TRANSMISSION

The new heavy-duty synchro-mesh transmission offers the very finest in standard driving with outstanding gasoline economy. It brings you extra durability—plus extra-smooth operation. Teamed with Fuel-Saver axle and either the new 123-h.p. six or the great new V8.

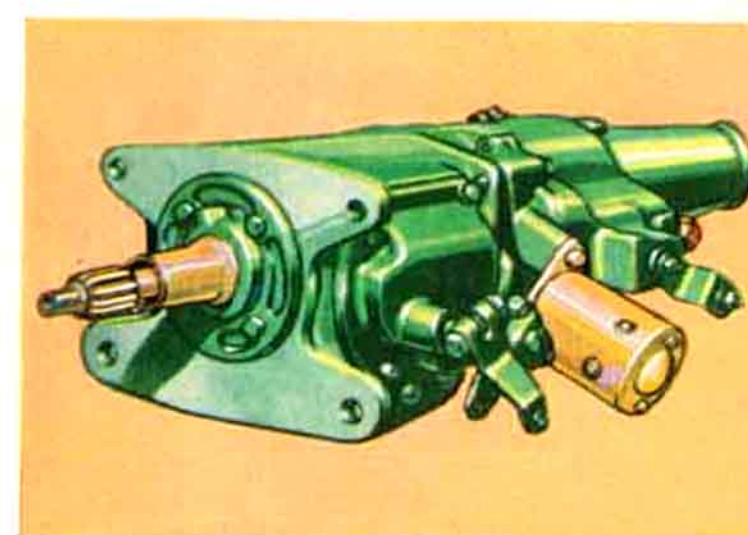

NEW TOUCH-DOWN OVERDRIVE

Here's great new driving flexibility and wonderfully responsive performance combined with big gas savings! Teamed with either the new 123-h.p. six or the great new V8 and new Power-Master rear axle, it's optional on all models at extra cost.

COMPLETELY NEW 1955 CHEVROLET CHASSIS

The 1955 Chevrolet is just as new underneath as it is "topside"! This completely new chassis is what makes driving the new Chevrolet such a wonderfully exciting experience. You'll find it brings you an entirely new feeling of stability and safety on the road . . . a minimum of pitch and roll on curves . . . almost unbelievable riding smoothness that makes back roads seem like boulevards! And with all its new nimbleness and big-car comfort, the new Chevrolet is every bit as dependable as you've come to expect a Chevrolet to be. In fact, it's designed to deliver a long lifetime of fine performance with even less maintenance than the thrifty Chevrolets of recent years.

NEW HOTCHKISS DRIVE

Drive line shocks are cushioned by new, longer rear springs with Chevrolet's new Hotchkiss Drive. Also, unsprung weight is substantially reduced. Both these factors are important reasons behind Chevrolet's wonderful new ride.

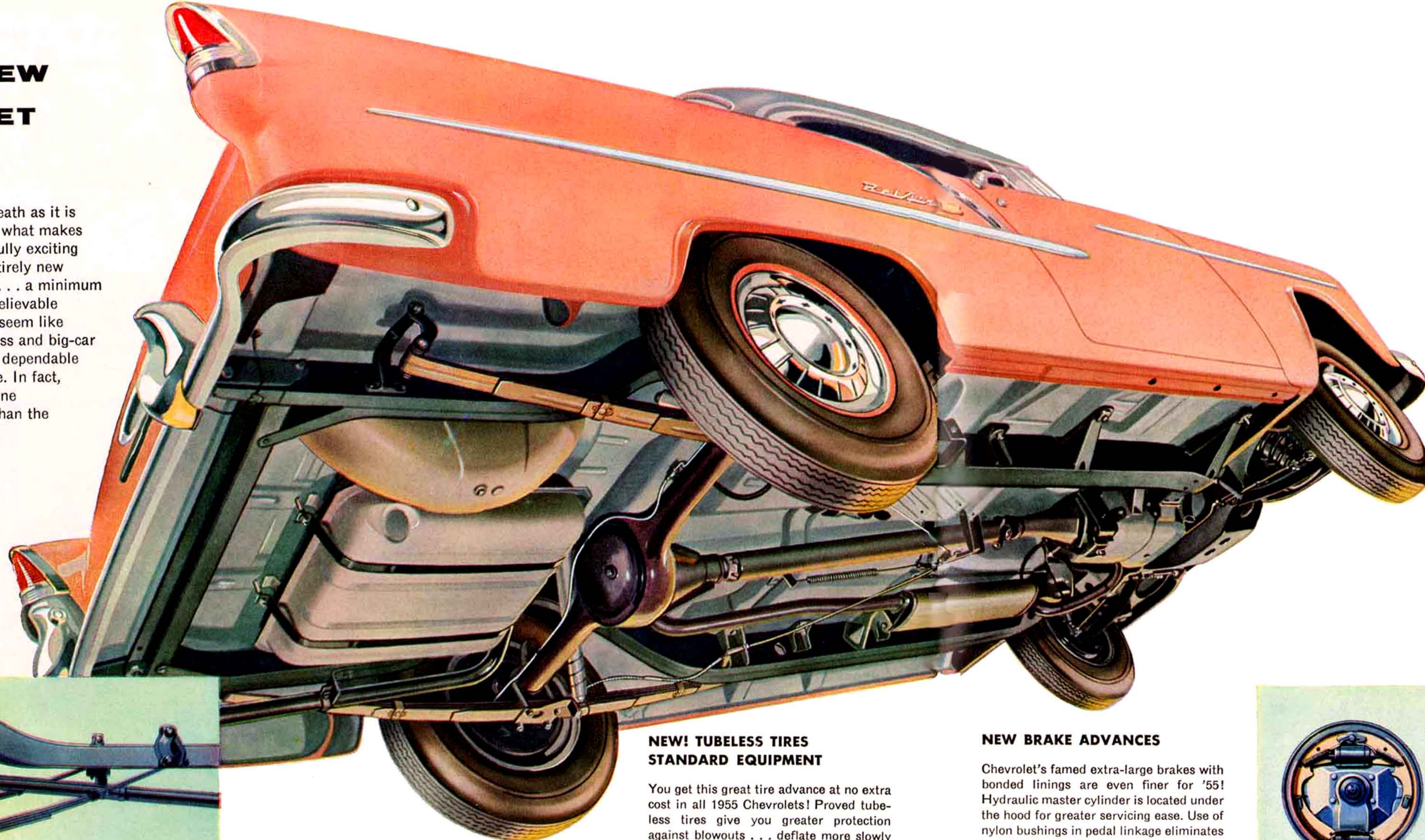
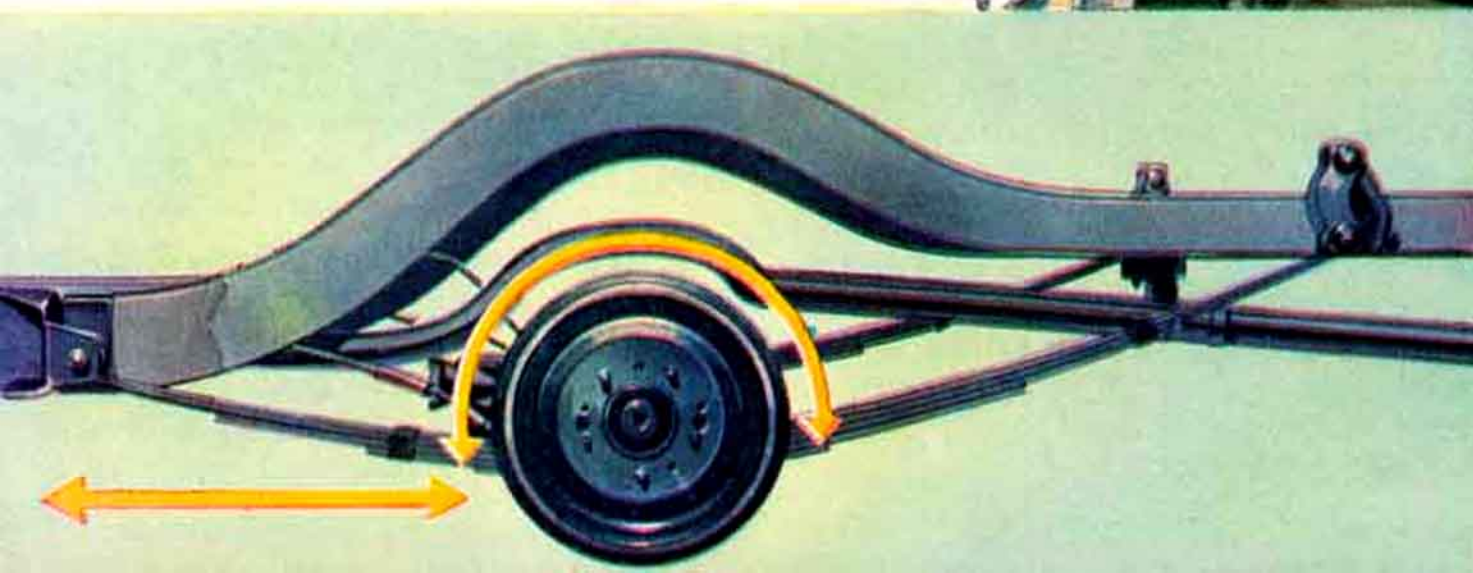

NEW! TUBELESS TIRES STANDARD EQUIPMENT

You get this great tire advance at no extra cost in all 1955 Chevrolets! Proved tubeless tires give you greater protection against blowouts . . . deflate more slowly when punctured.

NEW BRAKE ADVANCES

Chevrolet's famed extra-large brakes with bonded linings are even finer for '55! Hydraulic master cylinder is located under the hood for greater servicing ease. Use of nylon bushings in pedal linkage eliminates need for lubrication.

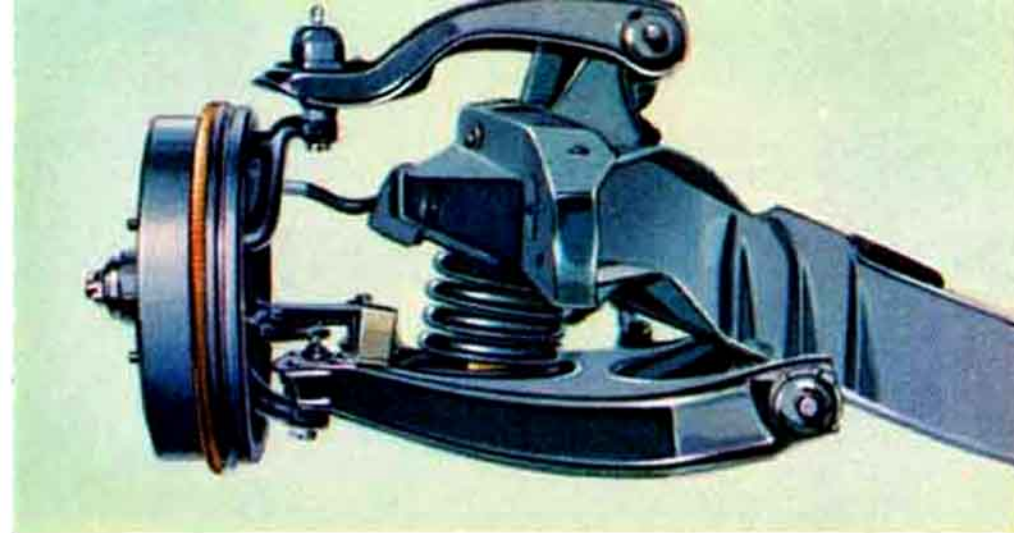
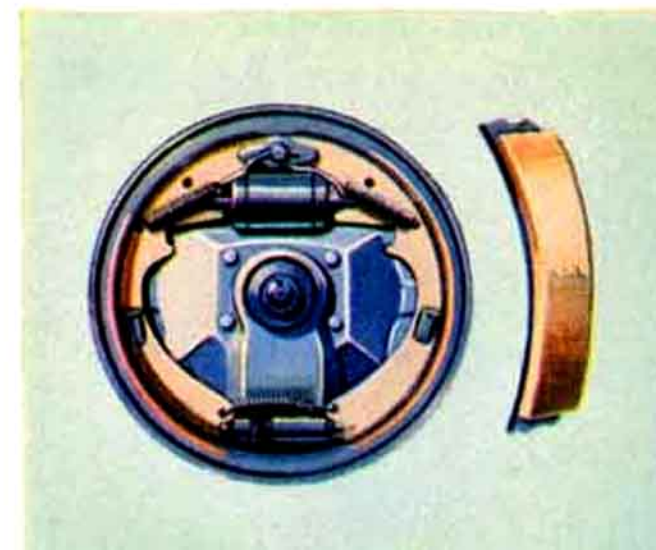

NEW KNEE-ACTION FRONT SUSPENSION

It's the greatest advance in riding comfort since Chevrolet's original Unitized Knee-Action! Four self-adjusting spherical joints absorb road shocks to help give you a wonderfully new kind of ride. And they require much less lubrication!



NEW ANTI-DIVE BRAKING CONTROL

This exclusive new Chevrolet development means "heads up" stops—even when you stop in a hurry. It greatly reduces passenger-pitching braking dive. And it lessens chances of bumper locking when you stop in close quarters.

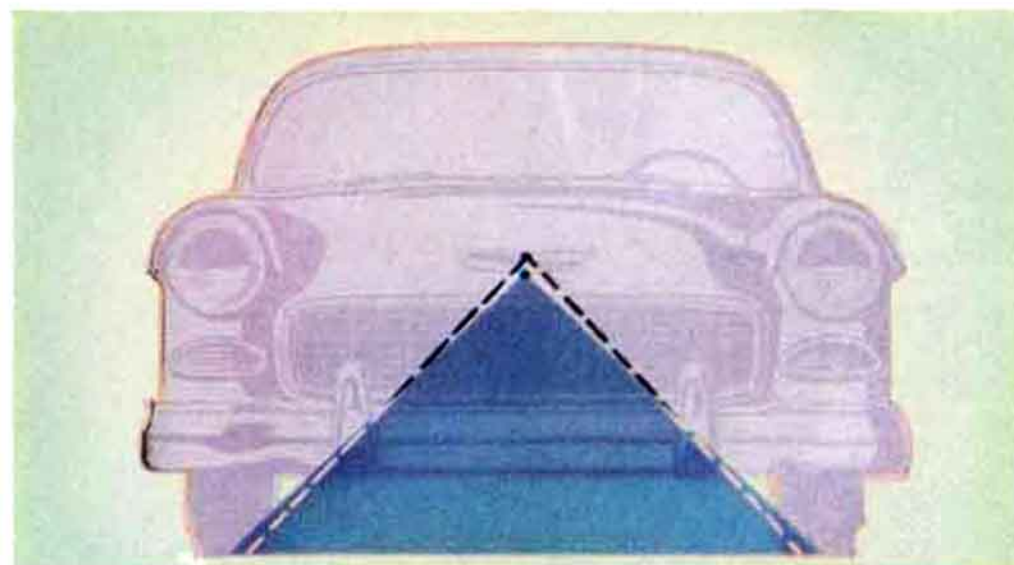

LOWER CENTER OF GRAVITY, WIDER FRONT TREAD

Here are two more important reasons behind the '55 Chevrolet's steady, road-hugging ride. The front tread is 1.3 inches wider. The center of gravity has been substantially lowered. The new Chevrolet is so stable that it requires no front-end stabilizing bar!



NEW ENGINE SUPPORTS

A newly designed engine mounting system cushions engine vibrations and power impulses with greater effectiveness. Live rubber mounts in front and rear support the engine in a naturally balanced position to give you silk-smooth performance at all engine speeds.

A WHOLE NEW DESIGN IN CHEVROLET'S BODIES BY FISHER

There's a lot more that's new besides the beauty in Chevrolet's sleek new Bodies by Fisher! The entire body structure has been redesigned and more closely integrated with the frame. Together with new manufacturing methods, this new design brings you great new strength, rigidity and roominess. And it contributes greatly to the solid and steady big-car comfort you'll enjoy in the new Chevrolet. Remember . . . Chevrolet's the only low-priced car to bring you the advances and advantages of the body used in many of America's highest-priced cars—Body by Fisher!

NEW! AIR CONDITIONING IF YOU WISH

Now Chevrolet brings the luxurious comfort of air conditioning to the low-price field. Combines heating and cooling in one highly efficient unit. And the whole thing fits compactly into the front of the car . . . requires no trunk space. Optional at extra cost.

NEW HIGH-LEVEL VENTILATION

Chamber at right receives air at hood-high level—away from road dirt, fumes and heat—and directs it under slight pressure to the passenger compartment. The result is more efficient ventilation—even on rainy days, since any water present is drained off by the chamber. This air chamber also gives increased strength and rigidity to the forward part of the body.

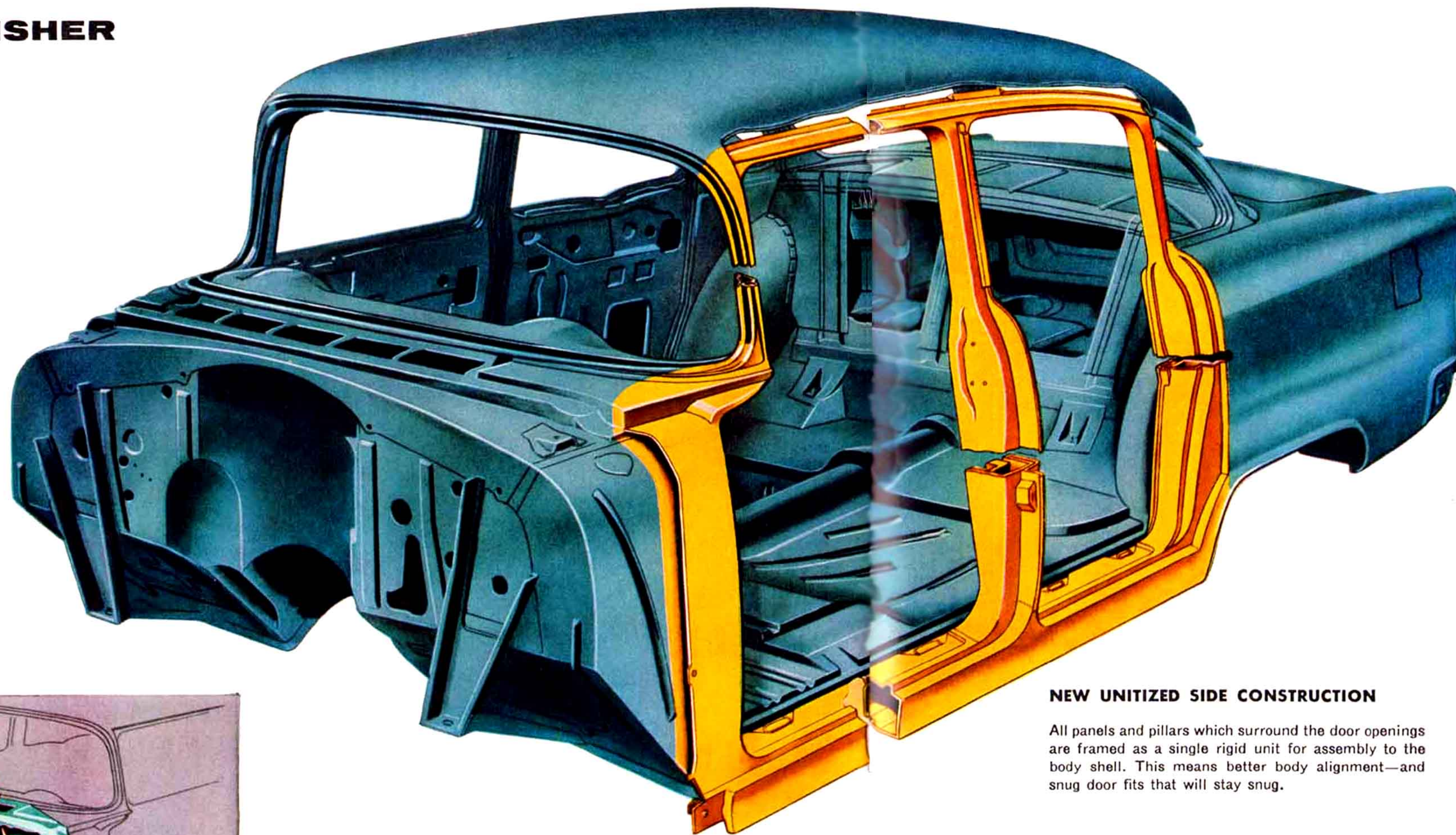
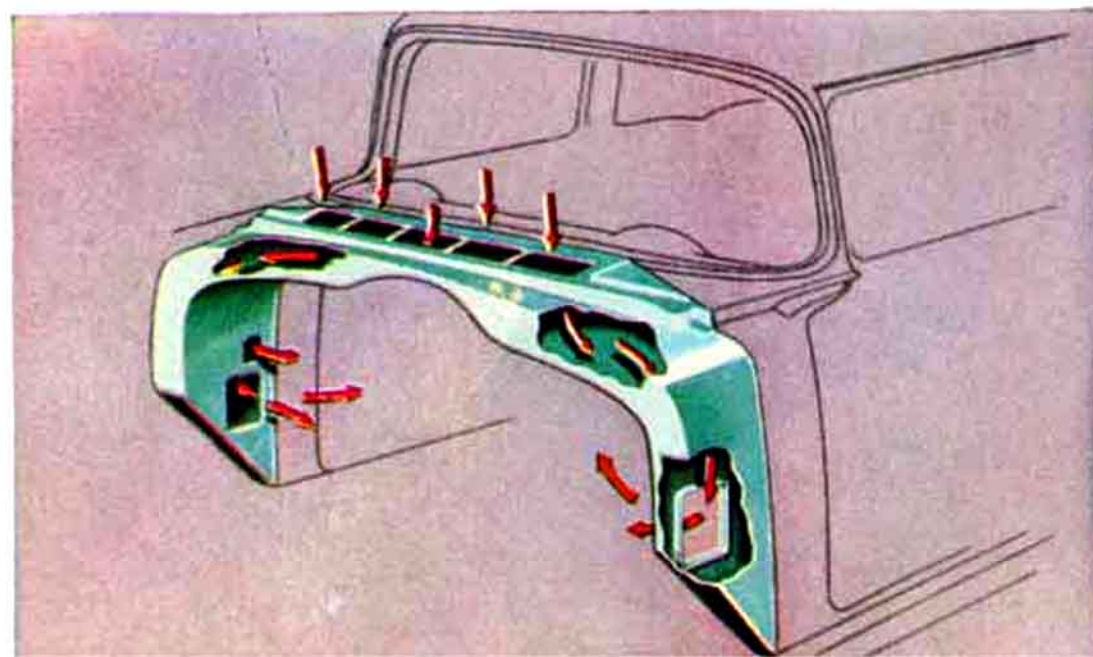

NEW UNITIZED SIDE CONSTRUCTION

All panels and pillars which surround the door openings are framed as a single rigid unit for assembly to the body shell. This means better body alignment—and snug door fits that will stay snug.



NEW RUBBER BODY-MOUNTS

Closed bodies are insulated from the frame at every mounting point by new live-rubber mounts. One more important reason for the whisper-quiet ride you get in the new Chevrolet!

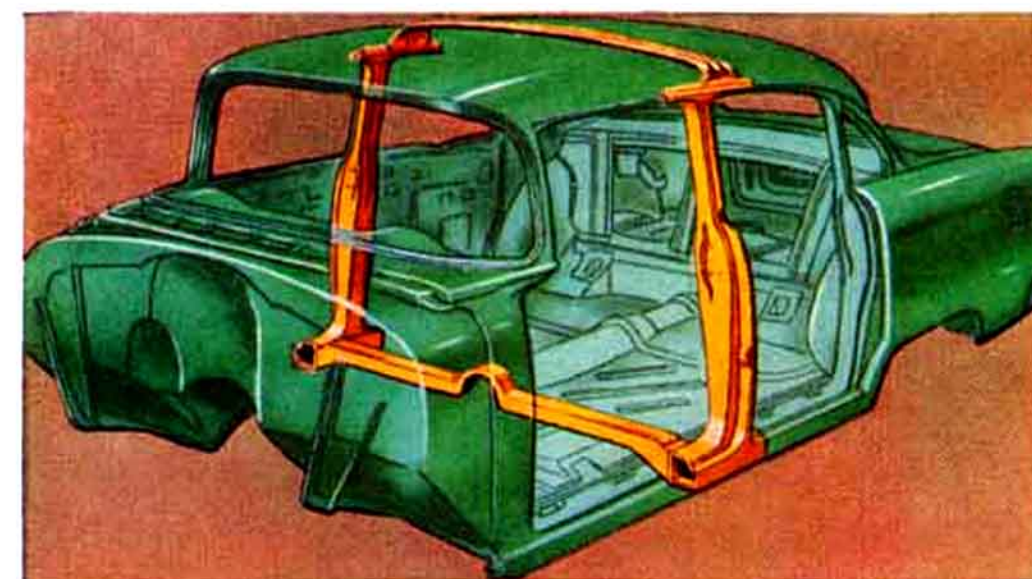

NEW CENTER FRAMING

The new center pillars, a new heavy-gauge floor brace, and the sturdy center roof bow team up to form a rugged structure at the center of the body. Here's extra strength for greater safety!



NEW, GREATER AREAS OF SAFETY PLATE GLASS

You can see more in all directions in the new Chevrolet! Four-door models, for example, bring you over 18 per cent greater glass area with 19 per cent larger windshield, 21 per cent larger rear window, and bigger side windows, too! All glass in all models is Safety Plate Glass for clearer visibility!



NEW LOW-LEVEL LUGGAGE COMPARTMENT

The roomy luggage compartment of the new Chevrolet is both wider and lower. The sill is almost flush with the floor, to make loading and unloading easy. And the lid is easier to open than ever—just a turn of the key and a light touch of your finger does it!



NEW LINKAGE-TYPE POWER STEERING

Chevrolet's new Power Steering is more compact, more accessible for service and more effective in cushioning road shock. In addition it provides easier power-off steering. Chevrolet Power Steering does up to 80 per cent of the work required to turn the wheels . . . makes parking and maneuvering in traffic far easier. Also, it helps you steer a straight course in spite of ruts, sand—or even a blowout. Optional on all models at extra cost.

CHEVROLET OFFERS NEW AND IMPROVED AUTOMATIC POWER HELPERS

POWER CONTROLS ON ALL WINDOWS POWER-POSITIONED FRONT SEAT

A finger touch automatically raises and lowers windows in front and rear both. Master control on left front door permits driver to control all windows. In addition, of course, each window has its own individual control for the convenience of passengers. . . . At the touch of a button, Chevrolet's Power-Positioned Front Seat moves to your most comfortable driving position. . . . These features are available separately or in combination as extra-cost options on all models.

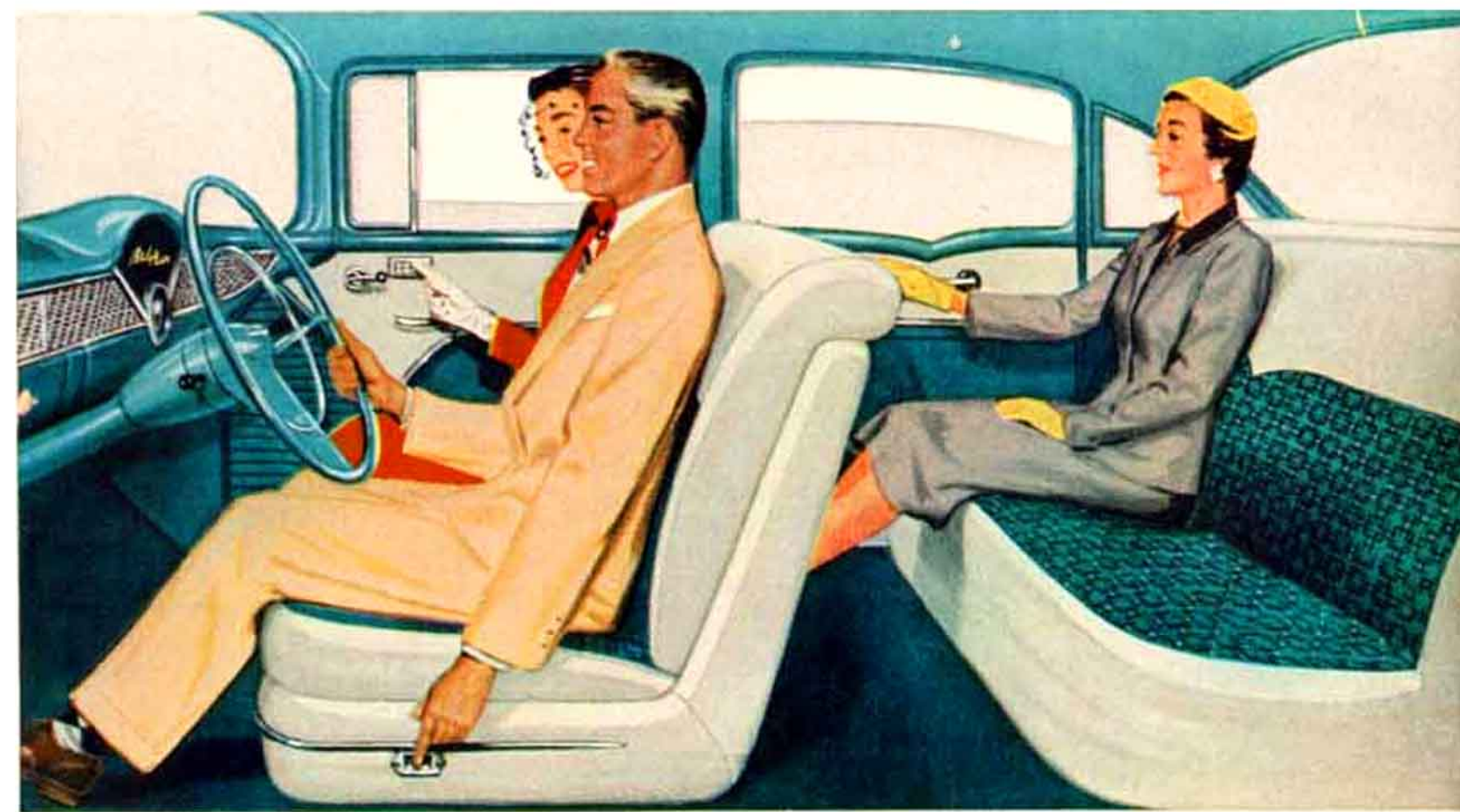
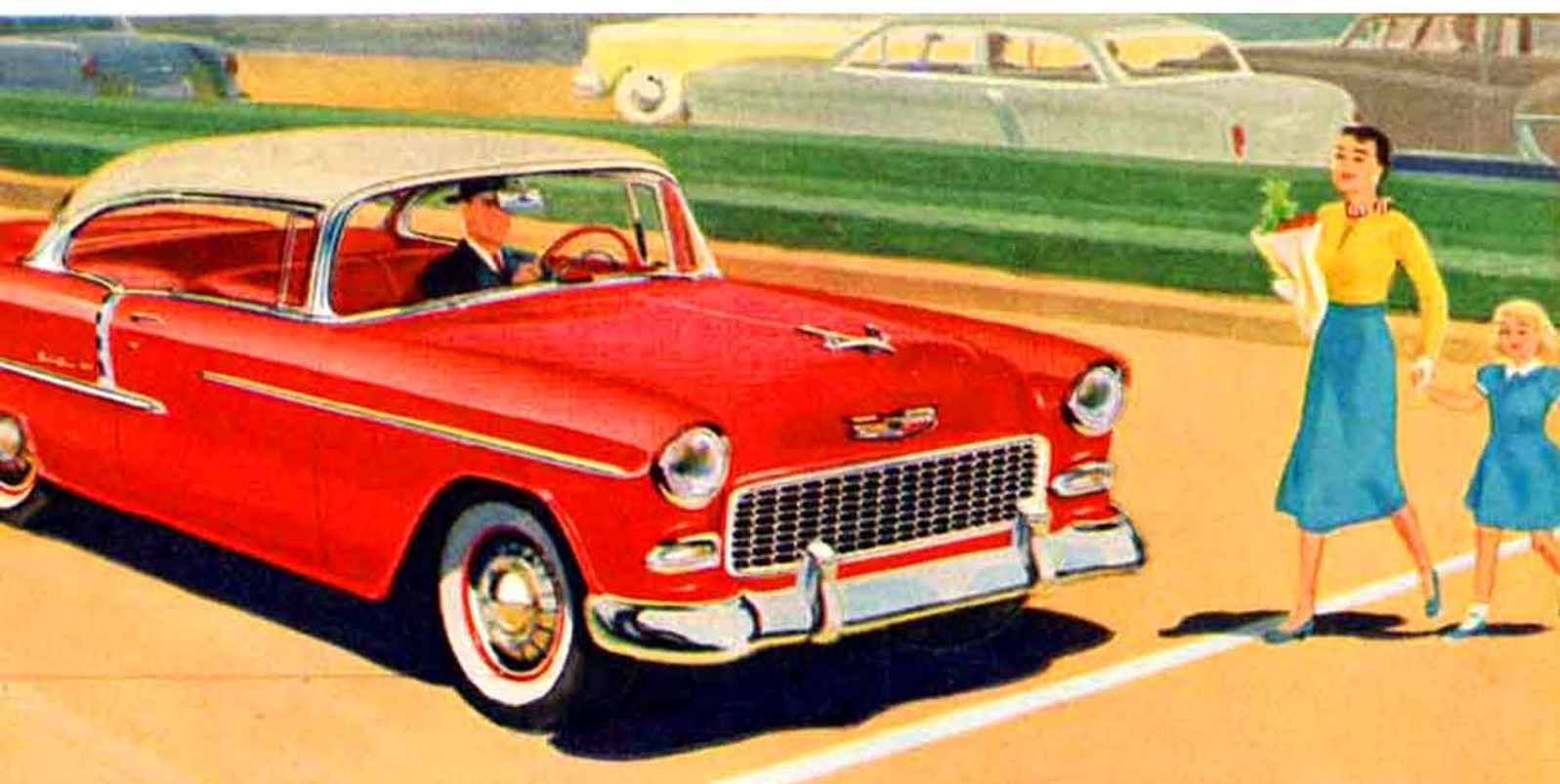

IMPROVED POWER BRAKES

Chevrolet's improved Power Brakes bring you easier power-off braking for greater safety. And they bring you to a stop with a light touch of the pedal. Optional at extra cost on all models.

ENGINEERING SPECIFICATIONS



CAR EXTERIOR DIMENSIONS

Sedans and Coupes: Overall length, 195.6". Overall width, 74.0". Loaded height, 60.5" (Sport Coupe and Convertible, 59.1"). **Station Wagons:** Overall length, 197.1". Overall width, 74.0". Loaded height, 60.8".

POWER PLANT

Engine: 6-cylinder or 8-cylinder, high-compression, valve-in-head engine (in choice of three power teams). Specifications listed below and in center chart.

Pistons: Tin-coated aluminum alloy, with expansion-controlling steel struts, offset pins, and three rings.

Crankshaft: Precision-counterbalanced, forged steel. Rubber-floated harmonic balancer. Alloy iron camshaft.

Bearings: Precision interchangeable steel-backed babbit crankshaft, camshaft, and connecting rod bearings.

Lubrication: Controlled full-pressure system. Floating oil intake. Crankcase ventilator. Refill, 5 qt. (V8, 4 qt.).

Fuel System: Downdraft carburetion. Automatic choke. Oil-wetted air cleaner. Thermostatic fuel mixture heat control. High-turbulence combustion chambers. 16-gallon tank (17, station wagons) with self-cleaning filter screen. Fuel filler inside of left rear fender, concealed by door.

Exhaust System: 30" reverse-flow muffler with three resonance chambers. Special 24" muffler for Convertible.

Cooling System: Ribbed cellular radiator with pressure cap. 4-blade fan and self-adjusting permanently lubricated water pump. Thermostat and by-pass temperature control. Full-length water jackets around all cylinders. Capacity, 16 qt. (17 qt. with heater).

Electrical System: 12-volt system. 54-plate battery (50 ampere-hour rating at 20 hours). 25-ampere generator, with current and voltage regulators. Solenoid-operated positive-shift starter. All-weather ignition. Automatic centrifugal and vacuum spark control.

Mounting: Dynamically balanced on rubber cushions.

SUSPENSION SYSTEM

Frame and Bumpers: Double-drop box-girder frame (with special X-structure of I-beams in Convertible). Contoured wraparound bumpers, with guards.

Front Suspension: Independent coil spring suspension, with coaxial life-sealed double-acting shock absorbers. Self-adjusting spherical-joint steering knuckles with non-metallic bearings. Four lubrication fittings.

Rear Suspension: Semi-elliptic leaf springs, 58" long by 2" wide. Lubrication-eliminating leaf inserts. Outrigger mounting, with compression shackles. Diagonally mounted life-sealed double-acting shock absorbers.

Wheels and Tires: Short-spoke steel disk wheels; 5" rims. Full wheel disks on Bel Air models; hub caps on others. 6.70-15-4 p.r. extra-low-pressure tubeless tires. Wheelbase, 115". Front tread, 58". Rear tread, 58.8".

CONTROLS

Brakes: Hydraulic, self-energizing, with bonded linings. 11" dia. drums with cast alloy iron braking surfaces. Braking dive controlled by car suspension system. Mechanical actuation of rear brakes for parking.

Steering: Recirculating ball-nut steering gear; ratio 20 to 1. Relay type linkage. Overall ratio, 25.7 to 1.

Driving Controls: 18" steering wheel (3-spoke on Bel Air models; 2-spoke on others). Full-circle horn ring on Bel Air and "Two-Ten" models; horn button on "One-Fifty" models. Transmission and direction signal* control levers, with mechanism inside steering column. Parking brake T-handle at left of steering column. Suspended brake and clutch pedals. Treadle accelerator. Foot-controlled headlight-beam switch. Light switch. Key-turn starter and ignition lock switch. Windshield wiper and ventilation controls.

Instruments: Speedometer. Fuel gauge. Heat indicator. Generator charge, oil pressure, and country beam warning lights. Direction signal* arrows. Adjustable indirect instrument lighting. Lighted automatic transmission* selector indicator on instrument panel.

Vision Aids: Two windshield wipers. Full-width defrosting. Inside mirror. Two sun shades (one, "One-Fifty" models).

Driving Lights: Sealed beam headlights, protected by dual circuit breakers. Parking lights. Tail and stop light units, with red reflex buttons. Dual rear license lights.

BODY CONSTRUCTION

Structure: Welded steel. Turret top with central bow (except Convertible). Full-length floor. Double-walled cowl. Unitized sides and rear fenders. Lacquer finish.

Closures: Rear-opening double-walled doors: Concealed hinges; swing-out type front door hinges. Door checks. Rotary locks. Pushbutton outside handles; lever inside controls. Button-on-sill latches, with rear door safety adjustment. Aluminum sill plates. Two-panel sedan and coupe deck lid: Concealed counterbalancing hinges, key release, lift handle, slam latch. Extra-low trunk sill. Box-section station wagon lift gate: Concealed hinges, self-latching supports, wedge lock. Double-walled station wagon tail gate: Exposed hinges, support cables with re-wind springs, slam latches operated by outside T-handle. Key locks for both front doors, deck lid or end gates. Front-opening hood: Counterbalancing hinges, slam latch with safety catch. Convertible folding fabric top: Zippered-in rear curtain with vinyl plastic window, vinyl boot, hydraulic operating mechanism.

Insulation: Thorough sealing and insulation. Extra top sound deadener in Bel Air and "Two-Ten" models.

Front Ventilation: High-level air intake in top of cowl; individually controlled outlets in cowl side panels.

Mounting: Rubber cushioned (except Convertible). Stabilized mounting of front fenders, hood and radiator.

BODY EQUIPMENT

Windows: Polished safety plate glass in windshield and all windows. Windshield: One-piece wraparound; vertical pillars. Door windows: Crank-down. Crank-operated front door ventipanes. Rear quarter windows: Crank-down (2-door sedans, coupes). Stationary (4-door sedans, Utility Sedan). Wraparound stationary (station wagons) with crank-down front sections ("Two-Ten" 2-door model). Rear window: Wraparound (sedans, coupes except Convertible). Curved (station wagons).

Seats: Full-width; all-steel frames with S-wire springs. Front seat: Solid back (4-door models); split center-fold back (2-door models). Foam rubber cushion (Bel Air and "Two-Ten" models). Inclined-plane seat adjustment. Rear seat: Foam rubber cushion (Bel Air and "Two-Ten" sedans, coupes). Folding seat (station wagons).

Upholstery and Trim: All vinyl (Convertible, Club Coupe, "Two-Ten" and "One-Fifty" station wagons); combinations of pattern cloth, gabardine, vinyl (others). Chrome front seat and side wall moldings (Bel Air and "Two-Ten" models); windshield top and side molding (Convertible); roof bows (Sport Coupe).

Floor Coverings: Carpet (Bel Air sedans, coupes; Club Coupe). Rubber mats (others), also sedan and coupe trunk, Utility Sedan load space. Linoleum on platform, tail gate, and surface of folded rear seat (station wagons).

Appointments: Wraparound instrument panel with instrument cluster in front of driver, matching radio grille, and central glove compartment with key lock. Automatic glove compartment light, ash receptacle, and cigarette lighter (Bel Air and "Two-Ten" models) and electric clock (Bel Air models). Four arm rests (Bel Air and "Two-Ten" models, except two in station wagons). Two rear seat ash receptacles (Bel Air and "Two-Ten" 2-door models; one, Bel Air and "Two-Ten" 4-door sedans). Two assist straps (Bel Air and "Two-Ten" 2-door sedans, Club Coupe). Package shelf (sedans, coupes except Convertible).

Lights: Central dome light (sedans, Club Coupe, station wagons). Two rear corner lights (Sport Coupe). Two courtesy lights under instrument panel (Convertible). Manual control by light switch on instrument panel. Automatic switches at all doors (Bel Air models, "Two-Ten" 2-door models); at front doors ("Two-Ten" 4-door models).

Exterior Chrome: Hood ornament, hood and rear emblems, light bezels, radiator grille, bumpers, ventipane frames, handles, hub caps or wheel disks (all models). "V" on rear fenders (V8 models). Windshield, window sill, rear side, and sash moldings ("Two-Ten" models). Windshield and side window moldings; rear window reveal (except Convertible); windshield pillar moldings; front, sash, and rear side moldings (Bel Air models). Special top and belt moldings, and winged spears replacing sash moldings (Bel Air and "Two-Ten" station wagons).

FACTORY-INSTALLED OPTIONAL EQUIPMENT*

Four-barrel carburetor and dual exhaust system for V8 engines. Overdrive. Automatic transmission, in combination with either 6-cylinder engine or V8 engine. Low-pedal vacuum-power brakes. Hydraulic power steering. Direction signals. Electric windshield wipers. Tinted safety plate glass. Electric-power window lifts. Electric-power front seat adjustment. Heater and defroster. Air conditioner. Whitewall tires.

POWER TEAMS	CONVENTIONAL		OVERDRIVE		AUTOMATIC	
	123-hp Six	162-hp V8	123-hp Six	162-hp V8	136-hp Six	162-hp V8
Engine Size	235.5 cu. in. displacement. 3.56" bore, 3.94" stroke. 7.5 to 1 compression ratio.	265.0 cu. in. displacement. 3.75" bore, 3.0" stroke. 8.0 to 1 compression ratio.	235.5 cu. in. displacement. 3.56" bore, 3.94" stroke. 7.5 to 1 compression ratio.	265.0 cu. in. displacement. 3.75" bore, 3.0" stroke. 8.0 to 1 compression ratio.	235.5 cu. in. displacement. 3.56" bore, 3.94" stroke. 7.5 to 1 compression ratio.	265.0 cu. in. displacement. 3.75" bore, 3.0" stroke. 8.0 to 1 compression ratio.
Engine Special Features	Concentric carburetor. 4-bearing crankshaft. Gear drive timing.	Dual carburetor. 5-bearing crankshaft. Chain drive timing.	Concentric carburetor. 4-bearing crankshaft. Gear drive timing.	Dual carburetor. 5-bearing crankshaft. Chain drive timing.	Concentric carburetor. 4-bearing crankshaft. High-lift camshaft. Gear drive timing. Hydraulic valve lifters.	Dual carburetor. 5-bearing crankshaft. Chain drive timing. Hydraulic valve lifters.
Clutch	9½" dia.	10" dia.	9½" dia.	10" dia.	Diaphragm spring type. Life-lubricated throwout bearing. Strap drive.	
Transmission	Heavy-Duty Transmission 3-speed, synchro-mesh, selective gear transmission, with gearshift lever on steering column. Gear Ratios: First 2.94 to 1 Second 1.68 to 1 Third 1.00 to 1 Reverse 2.94 to 1		Heavy-Duty Transmission plus Overdrive* 3-pinion, planetary gear overdrive, providing automatic fourth speed; gear ratio, 0.71 to 1. Accelerator control: Electric cut-in, through releasing treadle, at approx. 25 mph.; down-shift to direct drive by pressing treadle to floor. Pull-out knob locks out overdrive.		Automatic Transmission* Hydraulic, 3-element torque converter, with planetary gears for reverse and automatic low. Selector lever on steering column. Safety switch in starter circuit. Oil cooler integrated with engine cooling system. Maximum torque converter ratio, 2.1 to 1. Planetary gear ratio, 1.82 to 1. Maximum overall ratio, 3.82 to 1.	
Rear Axle	Semi-floating, with hypoid gears. One-piece "banjo" housing. Hotchkiss drive.					
	3.70 to 1 ratio		4.11 to 1 ratio		3.55 to 1 ratio	

All illustrations and specifications contained in this literature are based on the latest product information available at the time of publication approval. The right is reserved to make changes at any time without notice in prices, colors, materials, equipment, specifications and models, and also to discontinue models.

