

THE

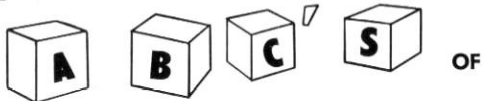

# ***FUEL INJECTION***

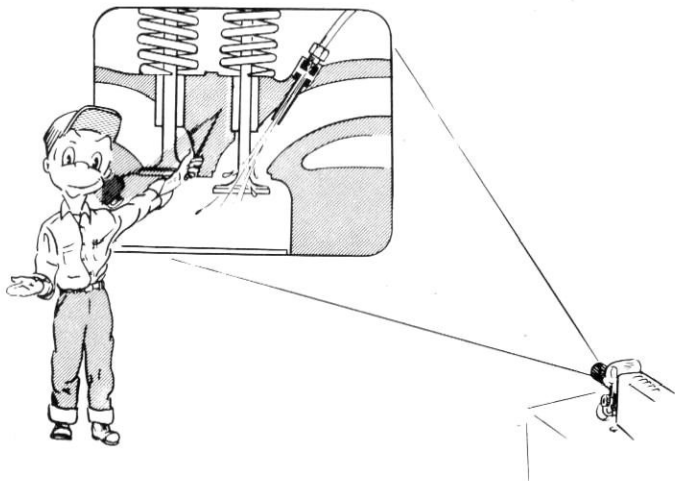

A ROCHESTER SERVICE TRAINING TEXT . . . Rochester Products Div.  
Gen. Motors Corp.  
Rochester, N. Y.

# WHAT IS FUEL INJECTION



Fuel Injection is a means of supplying fuel and air to an engine. Though its job is similar to carburetion it is much more efficient in many ways. From the illustration you can see that the most notable difference from carburetion is that the fuel is not mixed with the air until the air has very nearly reached the cylinder. In the carburetor fuel and air are mixed in the venturi and the intake manifold transports the mixture to the cylinders; in a fuel injection system the manifold carries only air and the fuel is sprayed under pressure into the air stream, either at the intake valve port or in the cylinder itself. The big difference then is in the fact that the manifold is not required to transport fuel/air mixture. It has been manifold limitations which have caused many carburetion problems and which led GM engineers to develop a new fuel injection system.

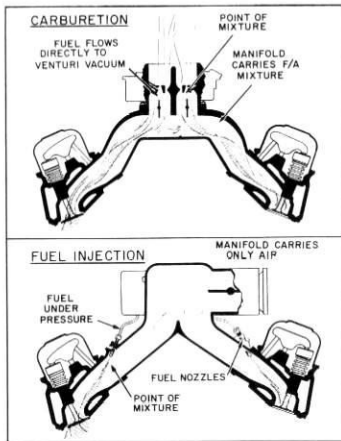

## Why F.I.?



Carburetors have come a long way over the past years, and engineering and production methods have combined to produce carburetors which get the most possible out of an engine. Carburetion does, however, have some limitations which can be overcome by fuel injection.

## FUEL DISTRIBUTION

One of the most important advantages of fuel injection is its ability to divide the fuel equally between all cylinders. From the illustration showing an exaggerated 8-cylinder manifold, it can be seen that when the manifold carries fuel/air mixture to a variety of sizes and lengths of passages, it is very difficult to feed each cylinder in equal amounts. As a matter of fact, it would not be uncommon to have 15% difference in fuel/air ratio between the leanest cylinder and the richest cylinder of a given engine with a carbureted fuel system. The main difficulty is that air is quite willing to flow around corners and through various shaped passages but the fuel, being heavier, is bothered by obstructions, curves, etc. In fuel injection fuel can be fed under pressure through a set of calibrated nozzles, one for each cylinder so that the fuel charge for each cylinder is virtually equal.

You can see that in the carbureted system it would be necessary to supply mixtures rich enough so that no cylinders were too lean, which means that there would be waste in the cylinders which were already rich enough. The engine equipped with fuel injection can often be run as much as 10% leaner than it would have to be with a carburetor and manifold.

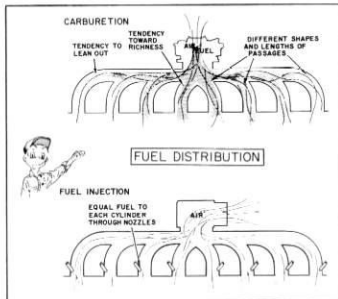

## AIR FLOW

In a carbureted fuel system the intake manifold must strike a happy medium between low and high speed requirements. At idle for instance, air flow is very slight and in order to keep the gasoline mixed with the air, it is necessary to have small passages to keep up the air velocity. On the other hand, when power is required, we would like to have as big a manifold passage as possible, to allow maximum breathing of the engine. Naturally, to supply both of these requirements, the manifold must be a compromise between small and large passages and results in passages of medium size which limit both the low and high speed performance, but provide enough of each to get by.

In the case of fuel injection, the manifold does not have to carry a fuel/air mixture and, therefore, can be designed to give the best breathing possible. In fact the manifold can be made to actually supercharge the engine at certain speeds. This is done by having a ramp for each cylinder so that the air on its way to the cylinder will be traveling in a long column, while the valve is open and air is entering the cylinder, the air flow gets quite a lot of momentum in the ram pipe. As the piston reaches bottom dead center and starts back up, air will continue to flow into the cylinder because of air velocity in the ram pipe. At the particular engine speed where the valve just closes as the air stops flowing, an extra charge of air has been trapped in the cylinder. This effect is called dynamic super charging; by design of the ram tubes a particular engine speed can be picked for this effect to occur and quite a boost in torque results at that particular point.

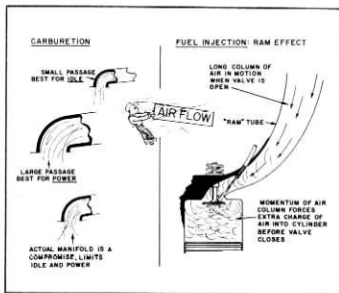

## MIXTURE HEATING

In a carburetor, mixture temperature is a problem during cold operation and it is necessary to bring exhaust heat through the heat riser in the exhaust manifold up to the base of the carburetor during warm-up. The unfortunate part is that this heat remains even when the engine is warm and often leads to vapor trouble, in addition to requiring periodic service to clean out the heat passages.

In fuel injection, on the other hand, fuel and air are actually mixed in a very warm part of the engine and no extra heat is required during warmup.

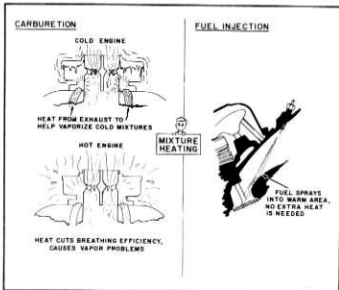

## HORSEPOWER

Many engineers feel that we are approaching practical limits of carburetion in size of venturi, number of cores, etc., and of course the farther we go in this direction the more difficult it becomes to maintain efficiency in the part throttle operation.

Since a fuel injection system could supply almost unlimited quantities of fuel and air, more efficient engine performance can be realized with today's engines. This allows considerable room for further advances in engine design.

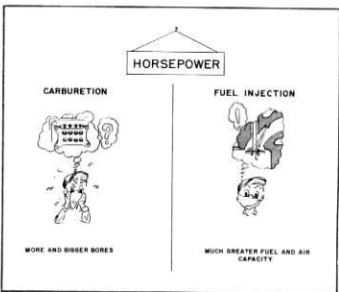

## HEIGHT

Styling of today's car has obviously become a very important factor and one of the trends is toward lower hood lines. Carburetor and air cleaner heights have been reduced year after year until it seems almost impossible to build them any lower. Since fuel injection does not require a down draft of air intake, it offers interesting possibilities in being able to reduce height for future styling requirements.

## OTHER ADVANTAGES OF FUEL INJECTION

Since fuel delivery does not depend on level of fuel in a bowl, operation of the fuel injection system is very little affected by maneuvers like tight turns and steep hill climbing.

Since the fuel is sprayed into the warm part of the engine, much less extra fuel is required before the system is operating at normal performance.

Response to the throttle is instantaneous since the fuel is under pressure at all times and needs only to be released for acceleration.

Another possibility in fuel injection is that fuel, since it is supplied separately from the air, can be shut off completely during deceleration if desired. This could reduce the amount of unburned hydrocarbons exhausted to the air and could also offer some improvement in fuel economy.

## TYPES OF FUEL INJECTION SYSTEMS

Different fuel injection systems can be described in two ways — by where the fuel is injected and by whether it is timed or continuous in flow.

One system which has been in use for many years is the timed direct cylinder injection such as used in a Diesel engine, where the nozzle is right in the combustion chamber and sprays fuel into the chamber when the piston reaches top dead center on compression. This system has been successfully used on Diesel engines but involves rather complicated and expensive timing devices and pump equipment.

A second system is timed port injection which is currently offered by several manufacturers. The nozzle is located in the intake port and sprays fuel toward the intake valve whenever the valve is open. The timing equipment required is still rather expensive and there is some question as to whether the timing of the discharge has enough advantages to offset the additional cost.

Continuous flow port injection has been used for some time as an accessory for racing application. Fuel is sprayed continuously into the intake port at such a rate that a full charge is delivered over a complete cycle of the engine. Since injection of this type involves a nozzle with no valve of any sort, vacuum effects on the fuel spray have been a problem. With pressure behind the nozzle and a variety of vacuum values ahead of the nozzle, it has been very difficult to control fuel flow, particularly at idle and low speeds.

After testing all the current systems at this time, GM engineers concluded that continuous flow port injection was the most practical system for American automobiles, for no system on the market had been able to provide the necessary full range in performance. Therefore, the GM Technical Center Engineering staff set to work to design a new continuous flow fuel injection system.

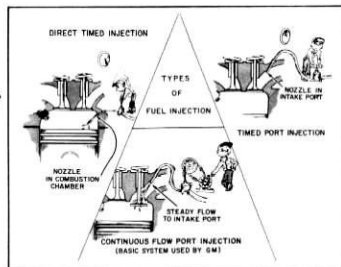
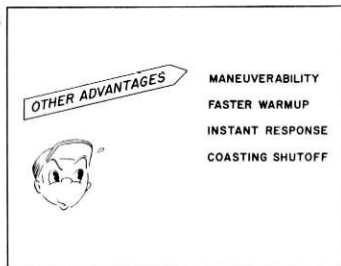
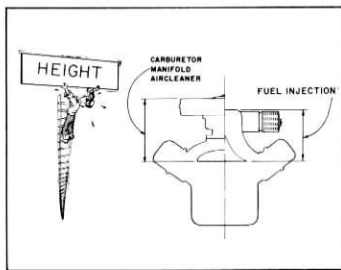

## GM SYSTEM FEATURES

The new fuel injection system is unique in several respects. The system contains a float controlled fuel reservoir for the high pressure gear pump, which eliminates the need for a pump overflow line to the gas tank. With this design there is always fuel available for starting. Since the gear pump is in the reservoir, no pump plumbing is required.

To avoid vacuum effects on the nozzle orifice which have caused previous trouble with continuous flow systems a vented fuel nozzle was designed in which the fuel is sprayed directly into atmosphere, across an air duct and through a small hole into the intake manifold. With this type of nozzle, vacuum effects are nearly nil and positive fuel control at all speeds is possible. Other features include mechanical simplicity, instantaneous response, and outstanding performance from low idle to full power.

## HOW DOES THE GM SYSTEM WORK

The GM system will be explained in the following text, first by basic principles, in simplified form, then by tracing each actual system of operation in a typical fuel injection unit. Since there are minor differences in various models for different cars, this will be a general discussion of a typical unit. On the last page of this booklet is a complete schematic drawing, with all the systems in their proper place and each important part identified.

## FUEL INJECTION REQUIREMENTS

The fuel injection system has the same old job to do that the carburetor has been doing so well for so many years. It is basically a matter of supplying combustible fuel/air mixture at the cylinder for ignition with a minimum of waste. To be a satisfactory fuel system it must be able to change mixture ratios for power and economy and to provide full performance throughout the range of cold operation, hot operation, and all driving conditions. The chief difference between fuel injection and carburetion is that fuel injection is able to do all these things more efficiently with potential increases in both economy and performance.

## NOZZLE PRINCIPLE

In the injection system for a typical 8 cylinder engine, fuel is supplied through 8 matched nozzles, each of which contains a calibrated orifice. Fuel flow at the nozzle depends on the pressure pushing the fuel; therefore, the control system for combining fuel with air will be a matter of regulating the fuel pressure to match the amount of air flowing.

### GM SYSTEM FEATURES



FUEL RESERVOIR  
NO RETURN LINE NEEDED



VENTED FUEL NOZZLE  
ELIMINATES VACUUM EFFECTS  
ON ORIFICE

MECHANICALLY SIMPLE

INSTANTANEOUS RESPONSE  
OUTSTANDING PERFORMANCE,  
FROM CURB IDLE TO FULL POWER



### HOW DOES IT WORK ?



### BASIC JOB - FUEL /AIR MIXTURE

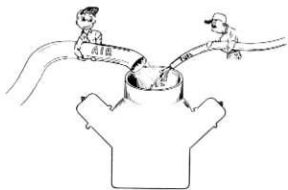

REQUIREMENTS - COMBUSTIBLE MIXTURE  
- POWER & ECONOMY CONTROL  
- FULL PERFORMANCE RANGE

### INJECTION NOZZLE PRINCIPLE

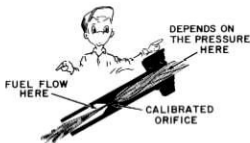

## BASIC FUEL CONTROL

Air entering the system passes through a venturi and causes a vacuum which indicates directly the amount of air flow. This venturi vacuum, plus the load on the engine, as indicated by manifold vacuum, provides a control signal which indicates how much fuel pressure should be supplied for the correct fuel/air ratio. If air flow increases fuel pressure must increase. If engine load increases fuel pressure must increase. When air flow or engine load decreases, pressure is decreased also so that fuel flow is less. Therefore, fuel flow will always be in relation to the amount of air that is flowing and the load on the engine.

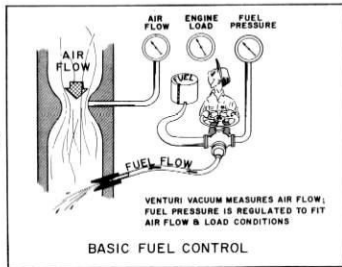

## GENERAL DESCRIPTION

The GM system has three basic parts — (1) the air meter, which must supply air in answer to the driver's foot and send a control signal to the fuel meter; (2) the fuel meter which pressurizes the fuel and feeds the correct pressure to the nozzles in answer to the control signal from the air meter; (3) the intake manifold supplies air from the air meter to the engine and contains a ram pipe for each cylinder. The following is a step-by-step description of these basic parts.

## FUEL SUPPLY

As shown in the drawing, the fuel meter contains a float controlled fuel bowl, very similar to those used in carburetion. Fuel is supplied to the fuel meter by a conventional diaphragm type pump and passes through a ten micron filter before it reaches the fuel meter. Fuel from the fuel valve splashes directly into the inlet cup where it spills over more evenly into the fuel bowl to avoid getting bubbles in the fuel which might be picked up by the gear pump. Float level although important is not as critical as in carburetion because the reservoir is merely a supply for the gear pump.

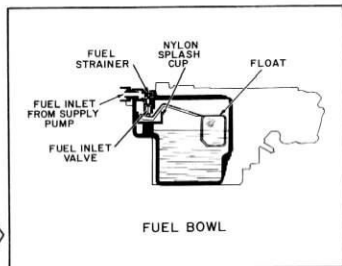

## HIGH PRESSURE GEAR PUMP

In the fuel bowl is a close tolerance gear pump which is driven by a flexible drive shaft from the electrical distributor at 1/2 engine RPM. The gear pump can supply pressures as high as 400 P.S.I. and has about twice the capacity of normal engine requirements at any speed. Fuel which is not supplied to the nozzles by the metering system, is spilled back into the bowl.

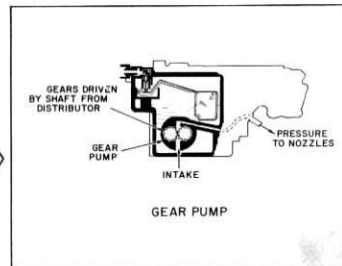

## FUEL PRESSURE CONTROL

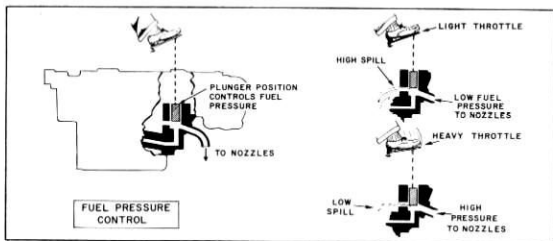

Pressure from the gear pump must be regulated to provide the right flow at the nozzles. Fuel in the metering system can go either to the nozzles or through another passage back to the bowl, through spill ports. The quantity delivered is controlled by a plunger which moves vertically to close or open the spill ports. In other words, if high spill is allowed delivery pressure is lowered or if low spill is allowed delivery pressure is raised. For high fuel flow high pressure would be needed and the spill plunger would be moved down to cover the spill ports and force more fuel through the

nozzles. For low flow the spill plunger would be raised so that more fuel is allowed to spill and there is less pressure to the nozzles. As shown in the illustration you could imagine the spill plunger position as being a direct result of the driver's foot on the accelerator pedal. When the driver pushes the accelerator and asks more power, the plunger moves downward to raise the fuel pressure. On the other hand, when the driver lets up on the accelerator, the spill plunger rises and decreases the fuel pressure.

## CONTROL LINKAGE

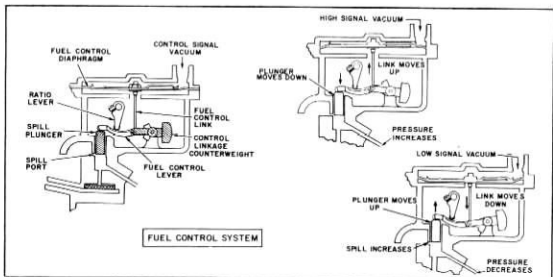

Of course the accelerator pedal is not directly connected to the spill plunger. Fuel control is accomplished by a very precise linkage system which is shown in the illustration. One end of the fuel control lever rests directly on the spill plunger and controls spill plunger position. The other end of the lever is connected by a link to the control diaphragm and the lever pivots around another part which is called the ratio lever. When the diaphragm pulls the link upward, the lever end pushes downward on the spill plunger to increase fuel pressure. When the diaphragm allows the link to fall, fuel pressure forces the spill plunger upward to open the spill ports and lower fuel pressure. This linkage system is so designed that it will balance at the particular point where the fuel pressure is correct for the amount of pull on the diaphragm. The linkage system is carefully counter-balanced so that the only

forces acting are fuel pressure and diaphragm vacuum. The small counterweight balances the weight of the fuel control lever itself. The large counterweight compensates for the weight of the entire system including the diaphragm. This precise balance is necessary if there is to be a quick reaction to slight vacuum changes on the diaphragm. The ratio of diaphragm vacuum to fuel pressure and thus the fuel/air ratio, can be controlled by the location of the pivot point or the ratio lever. Moving the ratio lever changes the mechanical advantage of the linkage system. For normal driving the ratio lever is in a fixed position and fuel pressure is a result of control diaphragm vacuum. When mixture enrichment is required the ratio lever is moved to change the mechanical advantage of the fuel control lever and thus change the fuel/air ratio.

## AIR METER

The two main parts of the air meter are the throttle and the venturi. The throttle controls the flow of air into the system and is connected directly to the accelerator through linkage. The venturi is a little different from the familiar type in which air enters through the center. It is a very high efficiency venturi and consists of a cone shaped diffuser suspended in the bore of the air meter, so that air can pass between the outside of the cone and the inside of the air meter bore. This type of venturi has hardly any restriction to air flow which is a vital factor in breathing capacity.

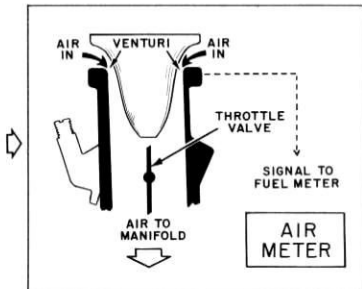

## CONTROL SIGNAL

Around the venturi is a groove which is open to venturi vacuum. Venturi vacuum is a measure of air flow and is used as a control signal, through a tube to the control diaphragm of the fuel meter. Since the venturi vacuum will always be a direct measure of the amount of air flowing, the metering system can be calibrated to feed a certain fuel pressure for a certain venturi vacuum, and thereby get the correct fuel/air ratio to the cylinders.

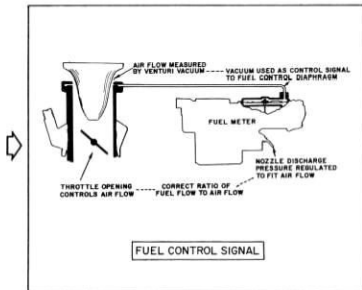

## AIR FOR IDLE

For idle the throttle valve is left closed in the bore and air is taken through a bypass around the valve and this idle air is regulated by a large idle air adjustment screw. Engine idle speed then can be controlled by turning the screw in or out to decrease or increase engine speed. In addition to the air through this bypass, a portion of the idle air enters directly through the air duct in each nozzle.

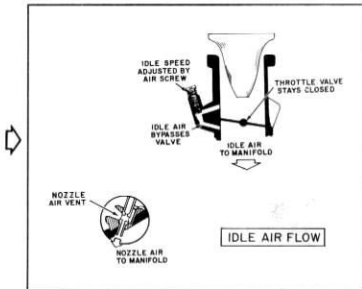



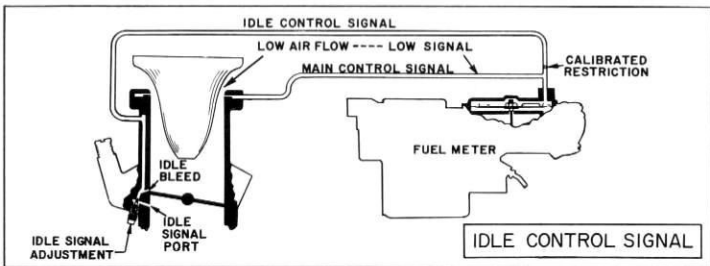

### IDLE CONTROL SIGNAL

At idle speeds and low throttle opening, air flow through the venturi is so slight that there is very little venturi signal. Since we must supply slightly richer mixtures for idle operation, additional vacuum is introduced into the signal system to increase the fuel pressure slightly. The passages shown in the air meter very much resemble the idle system in a carburetor. Below the throttle valve the idle system is opened to manifold vacuum. The amount of vacuum allowed to affect the system is controlled by an idle needle. Just above the throttle valve is a small hole which acts as a bleed at idle and as a vacuum source when the throttle valve is slightly open. Vacuum in the idle system is supplied to the diaphragm through a signal tube. The venturi signal and idle signal come together in a "T" fitting at the control diaphragm. At idle and very low speeds the idle signal system provides most of the control signal. As the throttle valve opens manifold vacuum drops and venturi vacuum increases so that the venturi control signal becomes the more important signal.

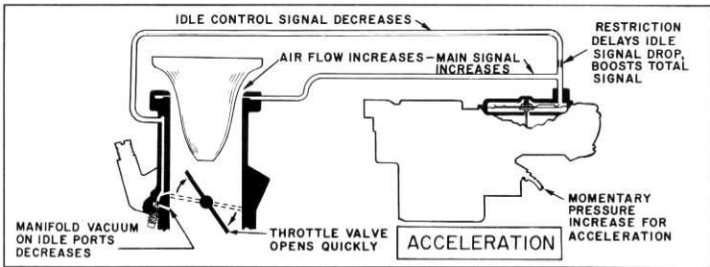
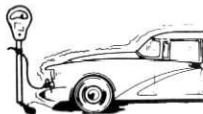

### ACCELERATION

At normal driving speeds acceleration is instantaneous. To prevent any possible lag at lower speed the signal system contains a restriction in the idle signal line which retains a momentary high signal at the diaphragm whenever the throttle is opened quickly. As the throttle is opened the venturi signal increases immediately and the idle signal drops off. The restriction in the idle signal line forces the signal to stay higher momentarily until it bleeds through the restriction so that there is a slight boost in signal for acceleration.



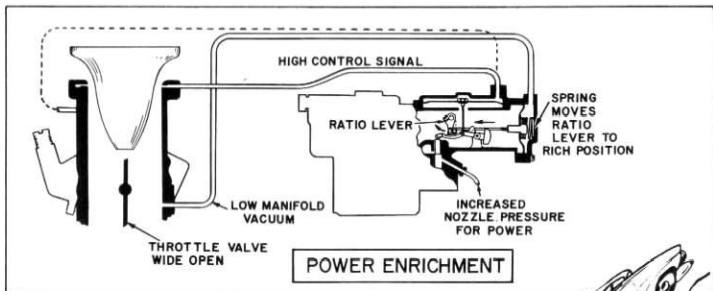

## POWER

For power operation richer mixtures are necessary and can be obtained by moving the ratio lever. Since manifold vacuum is the best indication of power requirements, the ratio lever is connected to a diaphragm which reacts to manifold vacuum. When the load is light and the vacuum is high, the ratio lever remains in economy position. When the vacuum drops with an increase in engine load, a calibrated spring behind the diaphragm moves the ratio lever to power position. The mixture limits of economy and power ratios are pre-set at the factory by stop screws which limit the movement of the enrichment linkage.

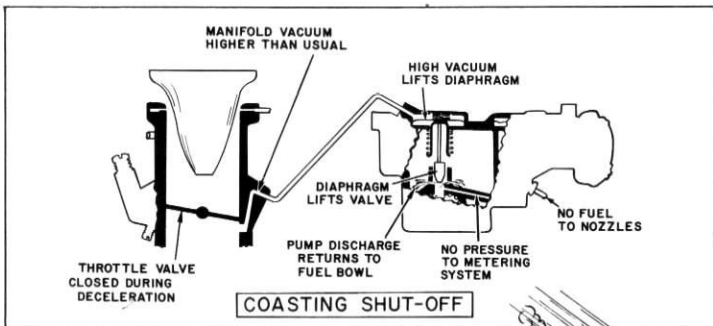
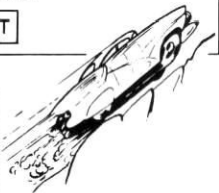

## COASTING SHUT-OFF

In those units which use the coasting shut-off there is a spring loaded valve in the high pressure gear pump. During normal operation the spring keeps the valve closed so that full pressure is delivered to the metering system. Whenever deceleration causes higher than normal vacuum, a diaphragm overcomes the spring and lifts the valve and allows gear pump delivery to return to the bowl so that there is no pressure on the metering system. Thus fuel can be cut off completely except when power is actually required from the engine.

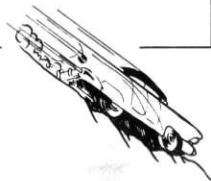

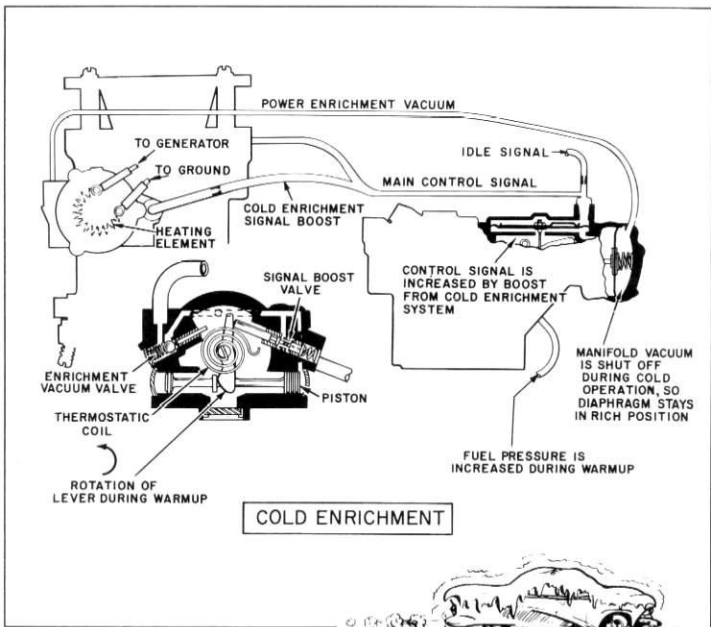

COLD ENRICHMENT

## COLD ENRICHMENT

In the fuel injection system there is no choke as such. Cold enrichment is obtained by adding more fuel rather than choking off the air. In the GM system two methods are used for cold enrichment; one simply shuts off vacuum to the power enrichment diaphragm so that power mixtures are used until the car is warmed up; the other introduces manifold vacuum into the signal system for an additional signal boost during cold operation. In various applications both systems are used separately or together. The illustration shows a system which will use a signal boost and power enrichment. If one or the other only were used it would simply be a matter of eliminating one valve and one tube. In the system shown, vacuum for starting the

engine would first pull the piston completely down and hold it there, which would index the lever to open the boost valve just the right amount and would also move the external linkage to set the fast idle cam on the second step position. Generator current heats a resistance element in the thermostat cover which heats the thermostatic coil until it begins to relax. As the coil relaxes the lever gradually moves until the bleed is closed. At this point there is no further signal boost but power enrichment is still used because manifold vacuum to the enrichment diaphragm is blocked by the spring loaded check ball. As the coil warms up still more, the lever opens the ball check valve to allow vacuum to the enrichment diaphragm and return the system to normal economy operation.

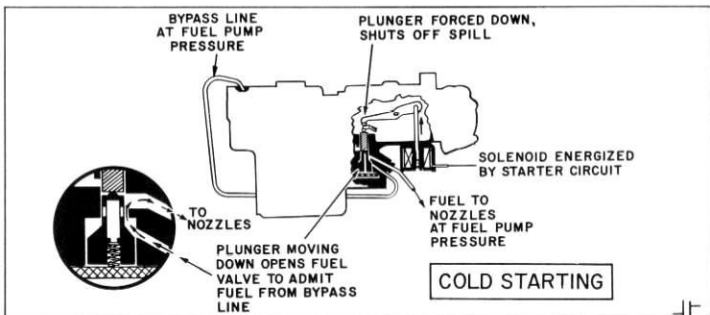

## STARTING SYSTEM

For cold starting extra fuel is needed to make up for poor fuel evaporation. At cranking RPM the gear pump delivery is often not enough for cold starting, so fuel pump pressure is taken directly from the fuel inlet to the fuel meter through a tube to the fuel metering system. A solenoid energized by the starter circuit pushes the spill plunger down to eliminate all spills and also open the fuel valve itself so that the starting bypass line can supply fuel directly to the metering system. As soon as the engine starts, the system reverts to normal operation.

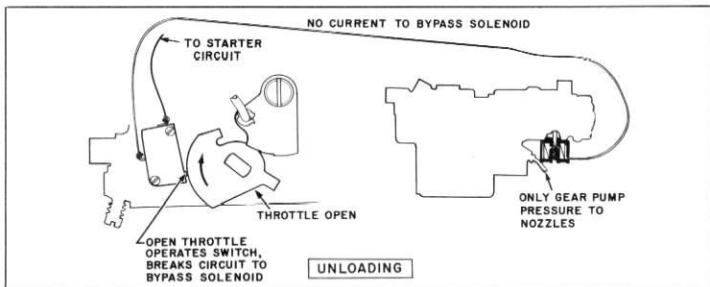

## HOT STARTING AND UNLOADING

For hot starting extra fuel is definitely not needed or desirable. To keep the solenoid from operating, a micro switch is provided so that when the throttle valve is open there is no current to the solenoid. With this particular type of starting mechanism it is important that proper procedure be used for both cold starts and hot starts. For cold starts the accelerator should be depressed once and then released, allowing the throttle to be pre-set for starting by the fast idle cam. Further

opening of the throttle would de-choke the system and prevent starting. For hot starting, the throttle should be opened until the micro switch breaks the circuit to the starting solenoid so that extra fuel is not introduced into the system. On the following two pages are complete details of a typical GM fuel injection system. Each important part is numbered and each number is listed on the opposite page with the part name and function.

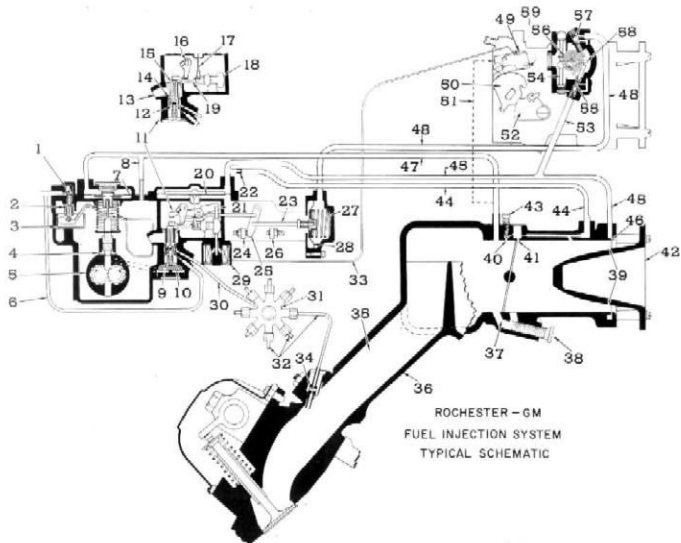

### INDEX FOR COMPLETE SCHEMATIC DRAWING

- |                                   |                                  |                                    |
|-----------------------------------|----------------------------------|------------------------------------|
| 1. Fuel Inlet Strainer            | 21. Starting Solenoid Lever      | 41. Off-Idle Port                  |
| 2. Needle and Seat                | 22. Signal Line Restriction      | 42. Venturi Diffuser Cone          |
| 3. Splash Cup                     | 23. Enrichment Control Rod       | 43. Idle Signal Needle             |
| 4. Coasting Shutoff Valve         | 24. Power Mixture Limit Stop     | 44. Idle Signal Tube               |
| 5. Gear Pump                      | 25. Enrichment Lever             | 45. Venturi Signal Tube            |
| 6. Starting Bypass Fuel Line      | 26. Economy Mixture Limit Stop   | 46. Airflow Sensing Groove         |
| 7. Coasting Shutoff Diaphragm     | 27. Enrichment Control Spring    | 47. Manifold Vac. to Vent @ C.S.O. |
| 8. Bowl Vent to Manifold          | 28. Enrichment Control Diaphragm | 48. Vacuum to Enrichment Diaphragm |
| 9. High Pressure Fuel Valve       | 29. Starting Bypass Solenoid     | 49. Unloader Switch                |
| 10. Fuel Valve Inlet Strainer     | 30. High Pressure Fuel Line      | 50. Throttle Lever                 |
| 11. Metering Linkage              | 31. Fuel Distributor             | 51. Vacuum to Air Meter Passages   |
| 12. Anti-percolation Check Ball   | 32. Nozzle Lines                 | 52. Fast Idle Cam                  |
| 13. Spill Return to Bowl          | 33. Solenoid Wire                | 53. Signal Boost Tube              |
| 14. Spill Port                    | 34. Fuel Nozzle                  | 54. Locating Piston                |
| 15. Spill Plunger                 | 35. Ram Tube                     | 55. Signal Boost Valve             |
| 16. Ratio Lever                   | 36. Intake Manifold              | 56. Thermostatic Coil              |
| 17. Control Diaphragm Link        | 37. Idle Air Bypass              | 57. Enrichment Vacuum Valve        |
| 18. Control Linkage Counterweight | 38. Idle Air Adj. Screw          | 58. Cold Enrichment Lever          |
| 19. Fuel Control Lever            | 39. Venturi                      | 59. Wire to Starting Circuit       |
| 20. Fuel Control Diaphragm        | 40. Idle Signal Port             |                                    |