

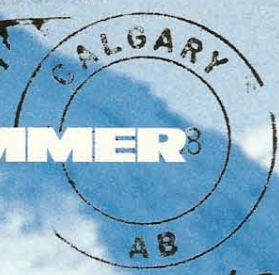

HUMMER[®]



1999

POSTAGE
5

epart...
ROSA...
A
CASTILLA... ROSALES...
EDUARDO...
10 FEB 1005

It's not a car. It's not a truck. It's not another sport utility vehicle. It's a Hummer – a vehicle that defies categorization, a vehicle that can go places and do things no other commercial wheeled vehicle in the world can.

The Hummer wasn't designed to meet the needs of the ordinary driver. Instead, it was engineered to meet the rigorous demands of the U.S. armed forces. They needed a vehicle like nothing in



The 1999 Hummer:

*A vehicle not in a class,
but a universe all its own.*

existence, a vehicle of enormous power and agility, a vehicle that could navigate impossible terrain and overwhelming obstacles, a vehicle that would last 12 years even with the most strenuous use.

AM General Corporation developed such a vehicle, and, save for a few refinements and creature comforts, the civilian Hummer vehicle is basically unchanged from its military counterpart.

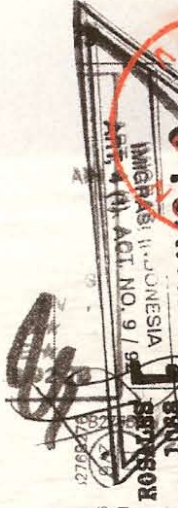

HUMMER®, HUMVEE®, ForqTrac 4x4 (TT4), Hummer Genuine™ Accessories and the vehicle's grille design are registered trademarks of AM General Corporation.

The Hummer's American roots can be traced back to 1903, when the company that would later be known as AM General was founded. Now in our eighth year of civilian production (with our fourth-generation workforce), we're proud to say that 90% of the Hummer's content is made in the U.S., higher than that of any other U.S. vehicle.

The world.

New this year is TorqTrac 4™ technology that monitors all four wheels and automatically stops tire spin while redistributing torque to the wheels that have traction. In other words, the most user-friendly 4-wheel drive on earth just got easier to drive.



Unabridged.

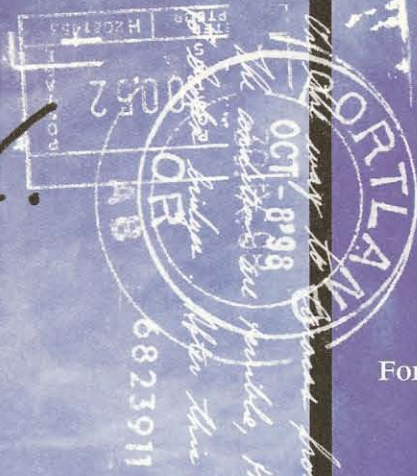

It's all in the name. The name of the vehicle that's built to survive to spend 14 days in the frozen north. The name of the vehicle that's built to survive to spend 14 days in the frozen north. The name of the vehicle that's built to survive to spend 14 days in the frozen north.

Scale a 22" vertical rock ledge

Ford 30" of water. Plow through a

three-foot snowdrift. Claw your

way up mountainous sand dunes

Climb 60% grades. Traverse 40%

side slopes. Go places and do things

that would be impossible in any

other commercial wheeled vehicle



FORM FOLLOWING FUNCTION IN ITS PUREST SENSE.

The Hummer looks the way it does because of what it was designed to do. Fleeting trends do not dictate its features. Its remarkable capabilities do.

A Hummer is engineered to have an unparalleled 16" of ground clearance (double that of most SUVs), 37" tires, steep angles of approach and departure for crossing ditches and gullies, and a 72" track width with a low center of gravity. The Hummer has full-time 4-wheel drive and a 4-wheel, fully independent suspension system complete with heavy-duty springs and hydraulic shock absorbers. And it's all powered by a 6.5L, 195-horsepower turbo diesel engine.

Wrap all of this up inside a heat-treated aluminum alloy shell that is not only lightweight but extremely durable and corrosion-resistant, support it with a box frame sporting five heavy-duty cross members that flex with the movement of the vehicle, and you have a vehicle like no other in the world.

VENTING SYSTEM

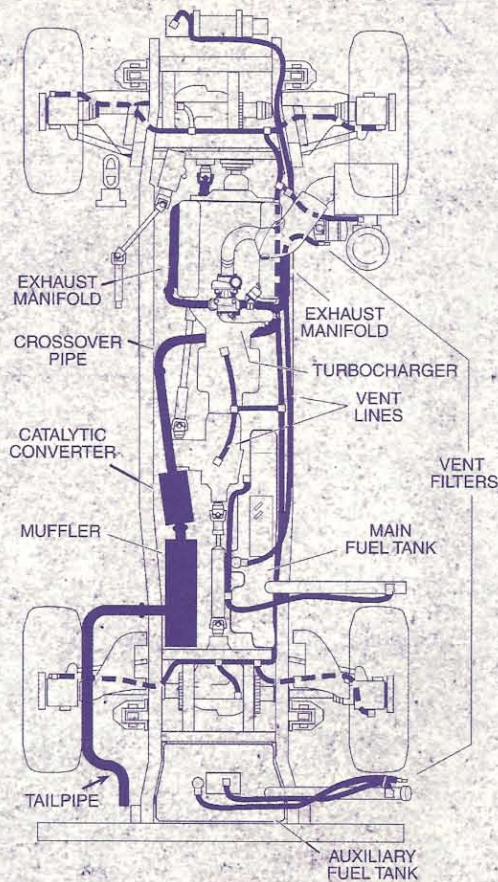

The Hummer has a sealed central venting system that protects major drivetrain components from contamination. A quarter-inch diameter hose connected to the vent on each component leads to a central hose connected to the air filter. This watertight system enables the Hummer to operate in up to 30" of water all day long without the threat of water, sand, silt or mud contamination.

CTIS

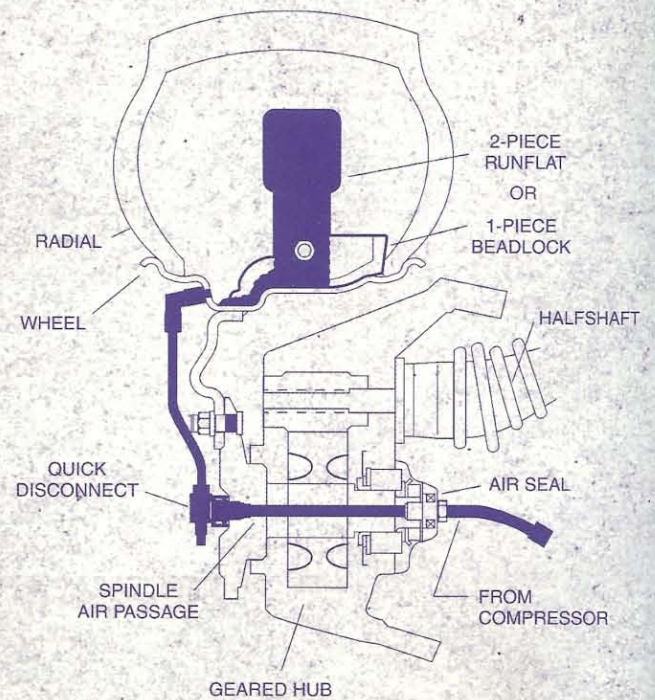

The Hummer's Central Tire Inflation System (CTIS) enables you to adjust tire pressure on the move to adapt to varied terrain. By deflating the Hummer's 37" tires, you get better traction in snow, loose sand, and mud. Softer tires also means less wear and tear on passengers and vehicle. Further, softer tires help you TREAD LIGHTLY™, preserving the natural environment. When you're back on solid ground, you can inflate the tires by simply flipping the switch on the dash while still on the go.

New this year is the Hummer's TorqTrac 4 (TT4) technology, which continuously monitors the rotational speed of each wheel. The unique TT4 4-channel system automatically reduces tire spin on severe terrain or slippery surfaces by applying the brake to the spinning wheel, allowing the differential to redistribute torque to those wheels with traction. Equipped with a Torsen® II limited slip torque-biasing differential and a locking transfer case, the Hummer's TT4 4-channel system provides the best mix of electronic and mechanical systems. Couple this with the Hummer's geared hub assembly, which provides a gear reduction of nearly 2:1 (doubling the torque to the wheel where you need it most), and there is very little terrain in the world that you can't negotiate.

TORQTRAC 4 (TT4)

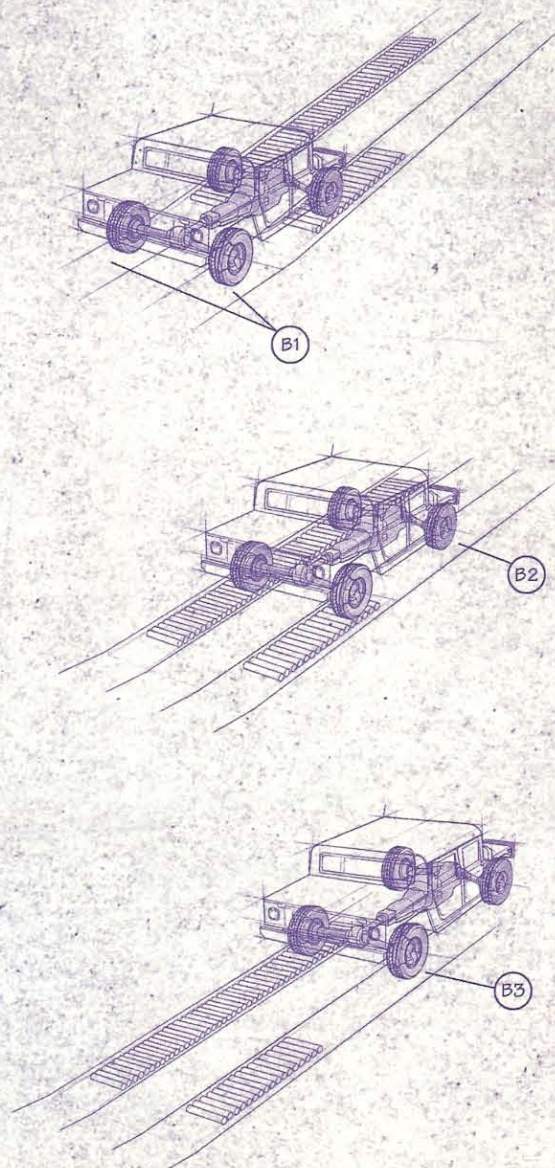

The roller-equipped slope best demonstrates the capabilities of the new TorqTrac 4 system.

DRAWING KEY NOTES

B1.
The Hummer approaching the roller-equipped slope first loses traction in the front two wheels. As the TT4 system slows the spinning front wheels, the transfer case redistributes power to the rear wheels with traction.

B2.
Here, brake action on all three spinning wheels sends torque to the right front wheel, the only wheel with traction, and the Hummer continues its climb.

B3.
Finally, the left rear wheel is spinning, activating the rear differential, which redistributes the traction to the right rear wheel, allowing the Hummer to successfully scale the slope.

APPROACH / DEPARTURE ANGLES

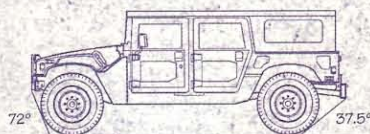

(Approach angle is 47° with winch)

HUMMER

PLAN KEY

VENTING SYSTEM

CTIS

TORQTRAC 4

PLAN C.528



*Some beasts mark their territories with
Some with their trophies.*

Off-road legend Rod Hall and the already legendary Team Hummer have quickly become the dominant force on the off-road racing circuit. Their string of major victories speaks for itself. And all those wins were accomplished in stock Hummers. The same exact Hummers available for sale to you. In fact, the only mechanical changes made to the race team vehicles were increasing the supply of fuel to the engine, increasing the RPM governor, advancing the timing, and adding some suspension and safety enhancements.

Unmodified Hummers were also the first and only motorized vehicles to cross Saudi Arabia's desolate Empty Quarter, the largest sand desert in the world. They have completed a 17,000-mile intercontinental environmental expedition from Venezuela to Alaska. And they have endured 9-day excursions across the North 65 latitude in Iceland.

Off-road racing and expeditions into uncharted territory provide the perfect testing ground for monitoring the Hummer's remarkable durability, reliability, and overall quality. They also provide a hotbed for product innovations and improvements that quickly get added to the Hummer's list of standard features.

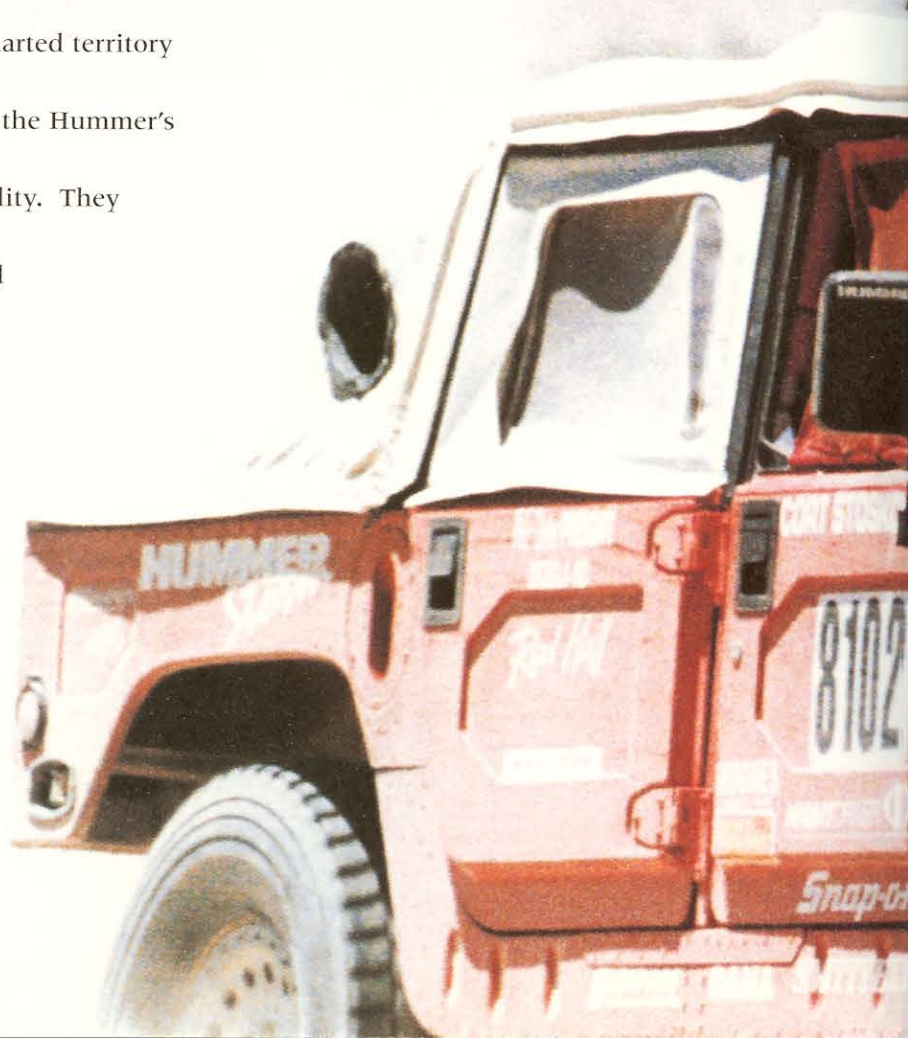

their scent.

Team Hummer Victories

- | | |
|--------------------|-----------|
| 1993 Baja 1000 | 1st Place |
| 1994 Banston-250 | 1st Place |
| 1994 Baja 500 | 1st Place |
| 1995 Gold Coast | 1st Place |
| 1996 Vegas to Reno | 1st Place |
| 1996 Baja 1000 | 1st Place |
| 1997 Mesquite | 1st Place |
| 1997 Tonopah | 1st Place |
| 1997 Vegas to Reno | 1st Place |
| 1998 Mesquite 300 | 1st Place |

But another Hummer that is class is what hope in pushing forward

the Baja Hunt to separate the places and the road conditions we have the most difficult

in the most difficult

the spirit of the

let me know

the spirit of the

let me know

the spirit of the

let me know

the spirit of the

let me know

the spirit of the

let me know

the spirit of the

let me know



The Hummer is as adept on the road as it is off. You'll find navigating a bank drive-through, city parking garages, and rush-hour traffic a breeze. With its power steering, 4-speed automatic transmission, and unique suspension system, it is surprisingly easy to maneuver. In fact, it handles more like a sports car than a truck. It also has an amazingly tight 26.5 ft. turning radius.

You'll also find the Hummer's interior quite comfortable, especially with standard features such as high-back bucket seats, a deluxe Delco sound system, a 124-amp alternator, a clock, power doors and windows, automatic transmission, power steering, power brakes, full instrumentation and an enhanced sound-

*Civilized.
Not domesticated.*

An optional Monsoon premium audio system, customized specifically for the Hummer's unique interior, is available. The system includes six coaxial speakers, pedestal-mounted tweeters, and a separate subwoofer enclosure for outstanding clarity.



dampening package. There's also plenty of head- and legroom and user-friendly controls and gauges. Options include a deluxe rearview mirror, a heated windshield, a premium Monsoon™ audio system, remote keyless entry, touring tires, and more.

You'll also appreciate the numerous safety features Hummer has to offer. Hummers meet or exceed all Federal Motor Vehicle Safety Standards for Class 3 trucks. The Hummer's list of safety features includes a padded dash, an energy-absorbing steering column, a steel roof, steel doors with side impact beams and ABS brakes.

Should a part ever need replacing, AM General has a network of dealers ready to service your vehicle.

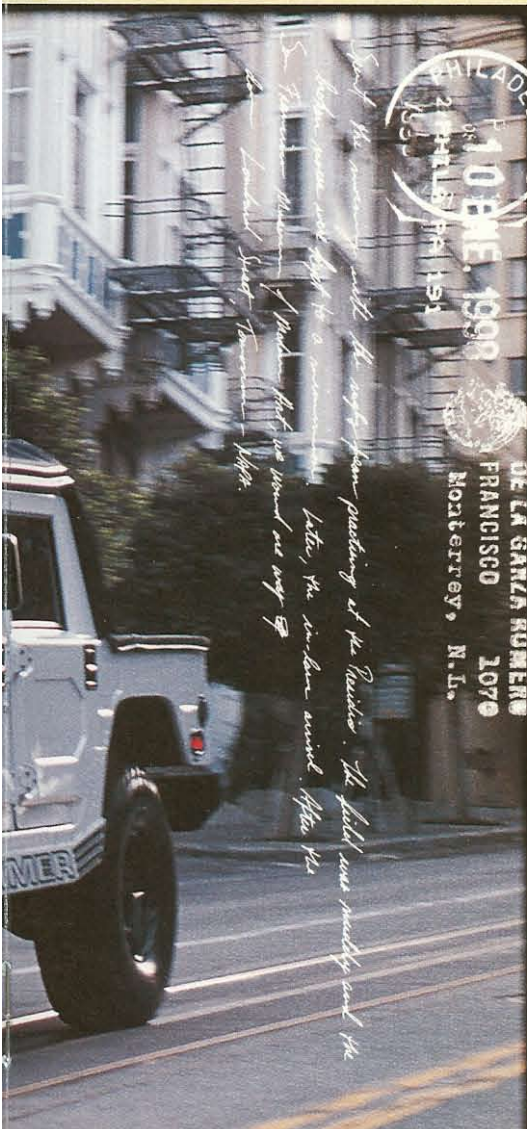

Your backstage pass to the

When you buy a Hummer, AM General will provide you a free one-year membership in the Tread Lightly program. Driving on public land is a privilege, not a right. So respect the environment and obey the law.

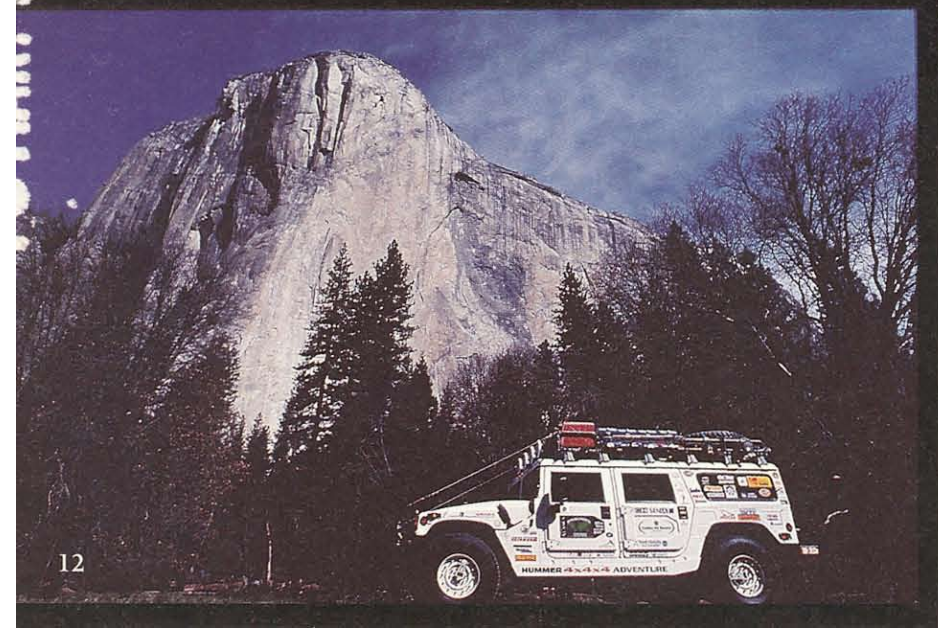

The true testing ground for the Hummer's raw capabilities isn't in a research facility but rather out in the thick of it all. But to go where the Hummer really feels the most at home, you'd have to be a little crazy. Either that, or you'd have to be Hummer Expedition Leader Tony Velazquez. His civilian-model Hummer has logged more than 31,000 miles over the most threatening terrain imaginable, including an

world.

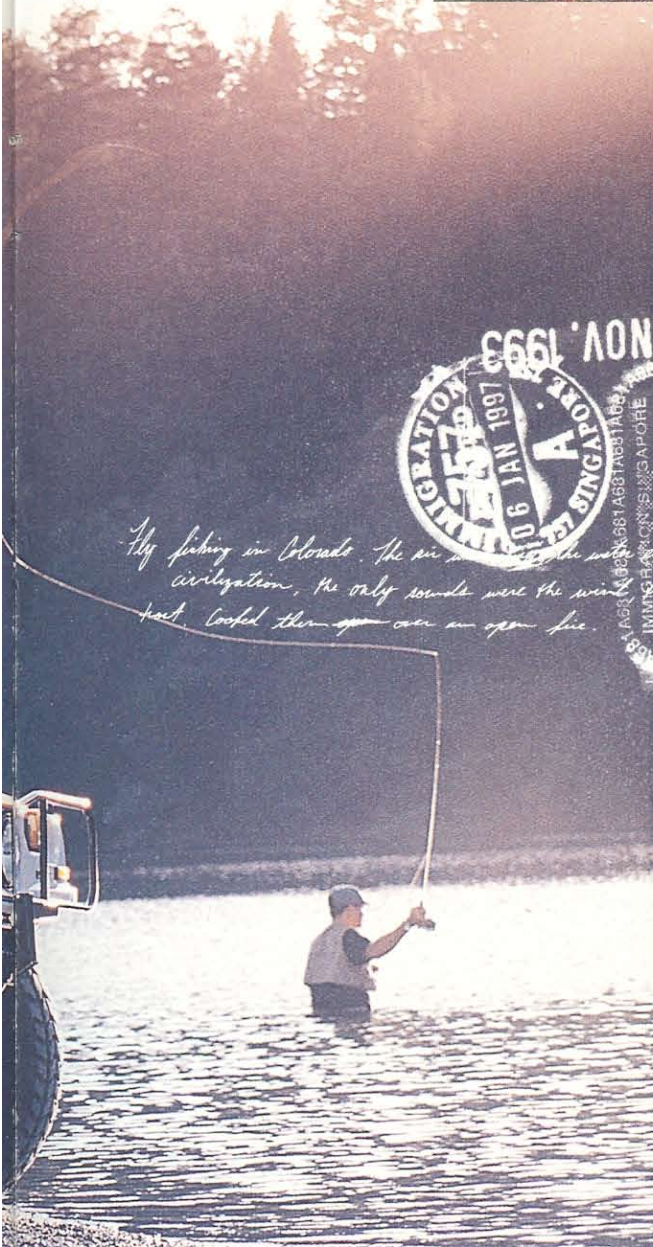

Fly fishing in Colorado. The air was crisp, the water clear. In the mountains, the only sounds were the wind and the water. We were so far from civilization, the only sounds were the wind and the water. When we cast our rods, caught to remember the best looked them up over an open fire.

intercontinental environmental expedition from Caracas, Venezuela, to Alaska. This maiden expedition included traversing the Dalton Highway, a famously treacherous path of ice from Fairbanks to Prudhoe Bay. Whether it was -73 degrees in Alaska or 113 degrees in the Baja desert, Tony's Hummer forged on. The team's second expedition took them through the deep jungles of Brazil. They traveled just 174 miles a day, encountering minor obstacles such as broken bridges and deep

sand, and reached Rio, unscathed, 14 days later. Tony is now planning a voyage through Russia to Mongolia. We'll keep you posted.

There's a whole world out there. A world without boundaries. A world very few have access to. You could be one of them. National and local Hummer clubs offer frequent opportunities to put your Hummer to the test at locations such as the Rubicon Trail in California and the rocky terrain of Moab, Utah.

The guts to take on the most

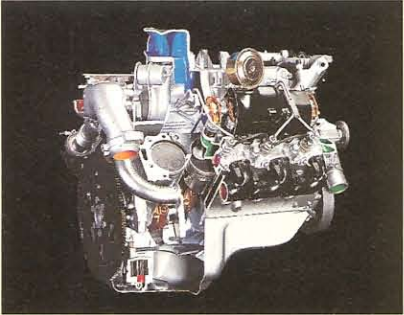

The Hummer is powered by a 6.5 L, 195-horsepower turbo diesel engine that generates 430 lb.-ft. of torque. Its near midship location provides excellent weight distribution.

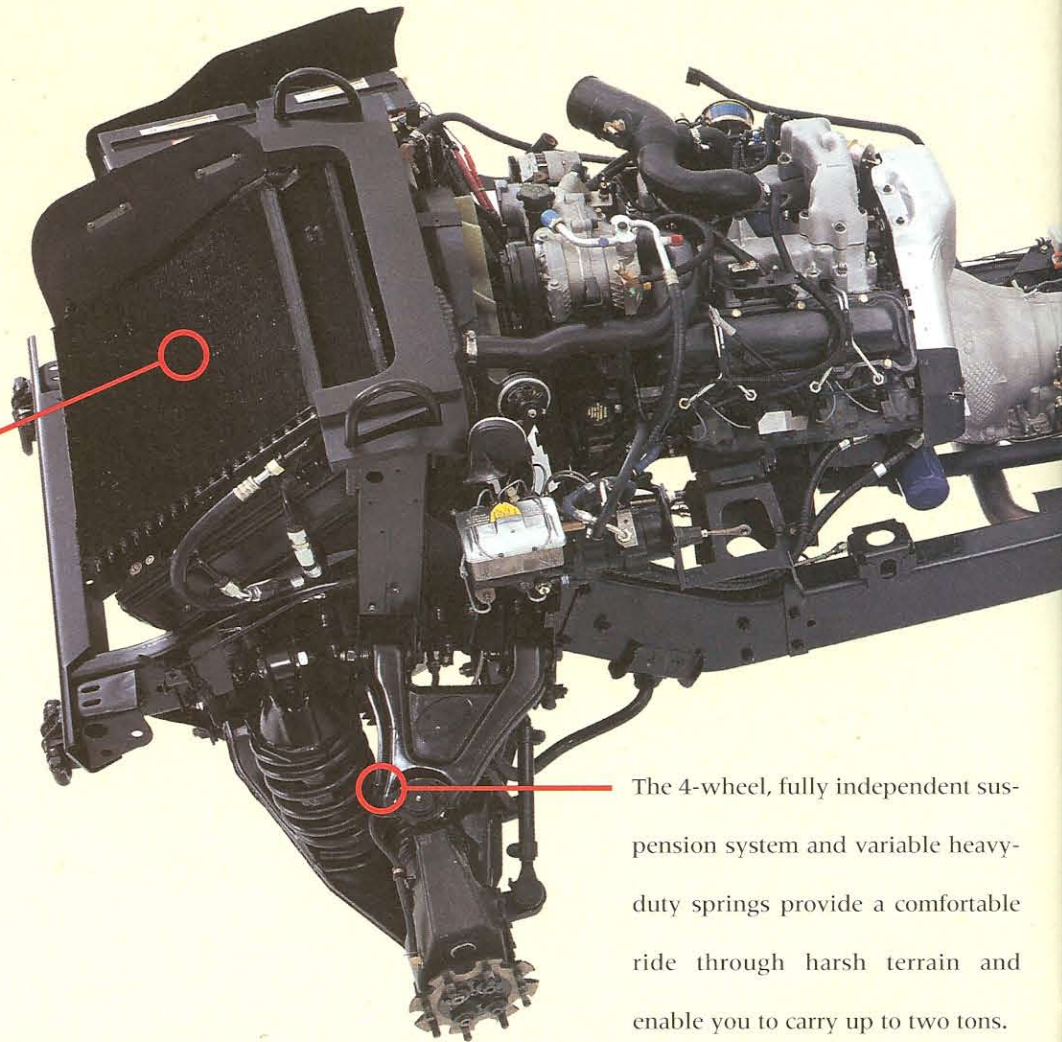

The Hummer's heavy-duty multiple cooling systems provide superior cooling capability for engine coolant, engine oil transmission / transfer case oil, and power steering fluid. Maintaining fluids at the correct operating temperature is important to increasing the life of power train components.

The 4-wheel, fully independent suspension system and variable heavy-duty springs provide a comfortable ride through harsh terrain and enable you to carry up to two tons.

The Hummer drivetrain provides an unprecedented total gear reduction of 33:1. The high mounting of the geared hub also contributes to the Hummer's unmatched 16" of ground clearance.

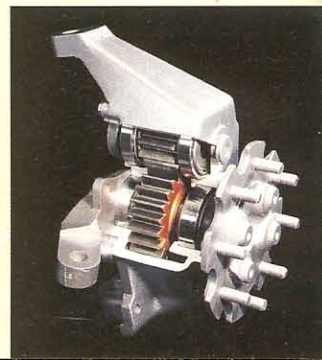

difficult terrain.

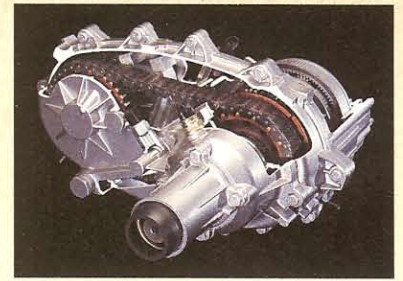

The Hummer's transfer case enables you to customize the drive-train configuration to match virtually any terrain. The transfer case provides a 4-wheel drive system with high and low ranges.

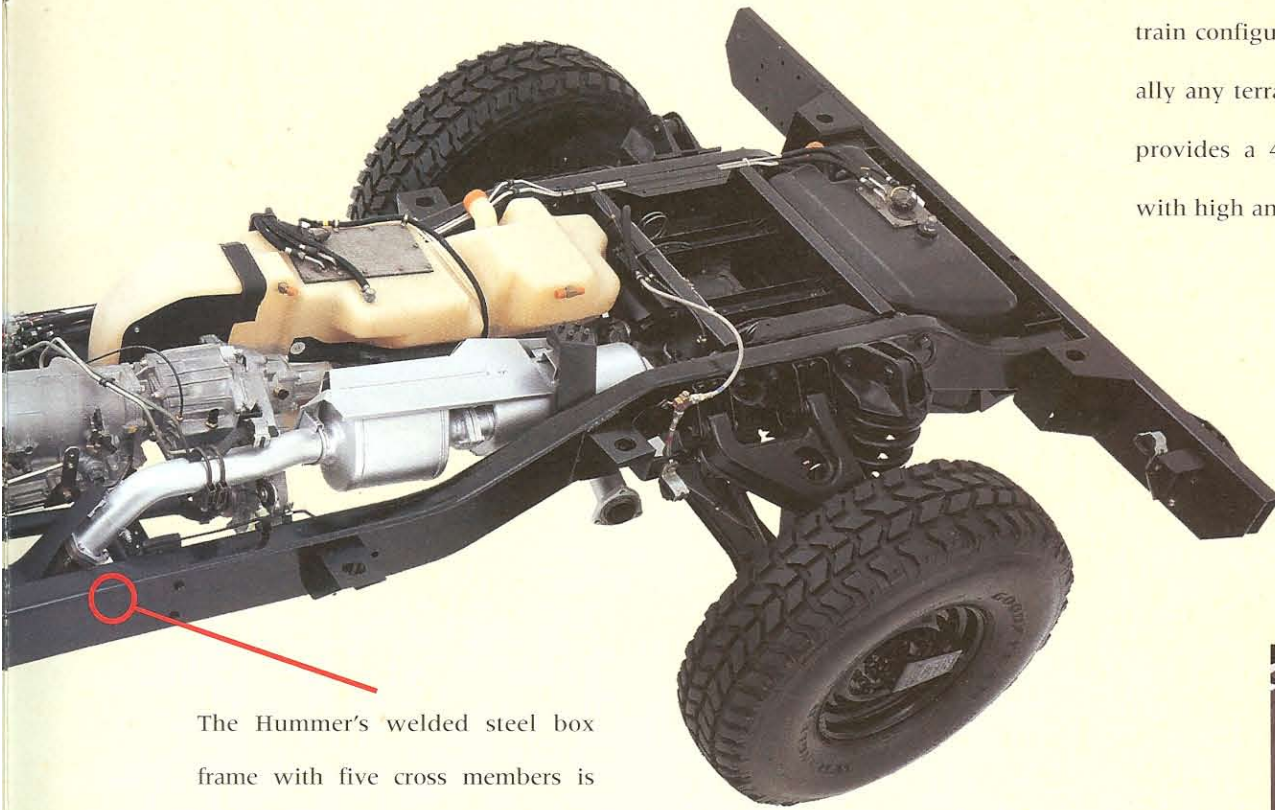

The Hummer's welded steel box frame with five cross members is extremely strong, yet flexible enough to absorb the stress of operating in severe terrain at full GVW.

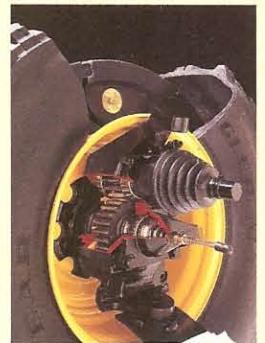

The Hummer can be equipped with a Runflat Tire System that allows you to travel up to 20 miles at 30 mph on flat tires. In other words, obstacles like low tire pressure or even a flat tire will no longer hinder your escape from a difficult situation.

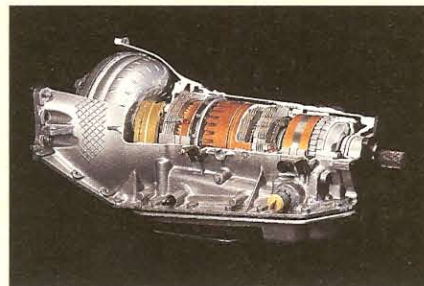

Power from the engine is transmitted to the Hummer's Hydra-Matic 4L80-E 4-speed overdrive electronic automatic heavy-duty transmission. Over time, it monitors your driving technique and adjusts to your driving style.



Off-Road Accessories Kit



Winch Accessories Kit

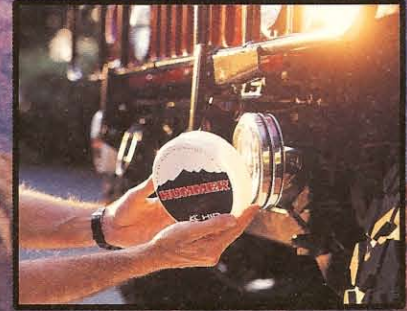

High Intensity
Discharge (HID) Lighting
System



Dash Appliqué



Stainless Steel
Wheel Covers



Pictured : cage-style roof rack, high intensity discharge (HID) lighting system, rocker panel protection decal, electric winch and winch roller fairlead. Also Available : hour meter • universal roof rack • bike / ski racks • dual oil filter kit • electric seat heaters • protective seat covers • auxiliary seats • Delco CD-changer kit • deluxe rearview mirror kit • traveler/survivor pak kit • winch kit • vehicle

Hummer Genuine Accessories



Bed Liner



Stainless Grille Cover



Leather Seating

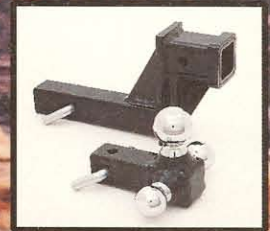

Tri-Ball Hitch Kit



Personalize your Hummer with Hummer Genuine™ Accessories. For a complete listing with photos, be sure to check out www.hummer.com, or ask your local dealer.

recovery strap • spare tire and wheel assemblies • swing-away spare tire carrier • bed-mounted spare tire carrier kit • floor mat kits • soft top cargo area extension • soft top slantback extension • snow chains • running board kit • removable running boards • tailgate decal kit • utility step • audio system infrared remote control • air filter restriction gauge kit • tire plug kit.

Specifications and Performance Data

	2-Door Hard Top		4-Door Hard Top		4-Door Open Top		4-Door Wagon	
	Standard	Metric	Standard	Metric	Standard	Metric	Standard	Metric
Curb Weight (Note 1):								
Turbo Diesel: 10,300 / 10,800 lb. GVWR	6,500 lbs.	2,948 kg	6,900 lbs.	3,130 kg	6,750 lbs.	3,061 kg	7,090 lbs.	3,216 kg
Payload (Notes 1 & 2):								
Turbo Diesel: 10,300 lb. GVWR	3,800 lbs.	1,724 kg	3,400 lbs.	1,542 kg	3,550 lbs.	1,610 kg	3,210 lbs.	1,456 kg
10,800 lb. GVWR	4,300 lbs.	1,950 kg	3,900 lbs.	1,769 kg	NA	NA	3,710 lbs.	1,683 kg
Gross Axle Weight Rating:								
Front: 10,300 / 10,800 lb. GVWR	4,100 lbs.	1,860 kg	4,100 lbs.	1,860 kg	4,100 lbs.	1,860 kg	4,100 lbs.	1,860 kg
Rear: 10,300 / 10,800 lb. GVWR	6,800 lbs.	3,084 kg	6,800 lbs.	3,084 kg	6,800 lbs.	3,084 kg	6,800 lbs.	3,084 kg
Maximum Towed Load (Note 3):								
Turbo Diesel: 10,300 / 10,800 lb. GVWR	8,300 lbs.	3,765 kg	7,900 lbs.	3,583 kg	8,050 lbs.	3,651 kg	7,710 lbs.	3,497 kg
Length (Note 1):	184.5 in.	4,686 mm	184.5 in.	4,686 mm	184.5 in.	4,686 mm	184.5 in.	4,686 mm
Maximum Height:	75 in.	1,905 mm	75 in.	1,905 mm	77 in.	1,956 mm	75 in.	1,905 mm
Width (Without Mirror):	86.5 in.	2,197 mm	86.5 in.	2,197 mm	86.5 in.	2,197 mm	86.5 in.	2,197 mm
Wheelbase:	130 in.	3,302 mm	130 in.	3,302 mm	130 in.	3,302 mm	130 in.	3,302 mm
Ground Clearance:	16 in.	406 mm	16 in.	406 mm	16 in.	406 mm	16 in.	406 mm
Track Width:	71.6 in.	1,819 mm	71.6 in.	1,819 mm	71.6 in.	1,819 mm	71.6 in.	1,819 mm
Grade Capability:	60%	60%	60%	60%	60%	60%	60%	60%
Side-Slope Capability:	40%	40%	40%	40%	40%	40%	40%	40%
Approach Angle Without Winch:	72°	72°	72°	72°	72°	72°	72°	72°
Approach Angle With Winch:	47°	47°	47°	47°	47°	47°	47°	47°
Departure Angle:	37.5°	37.5°	37.5°	37.5°	37.5°	37.5°	37.5°	37.5°
Runflat Capability (Note 4):								
(At 30 mph)	20 miles	32.2 km	20 miles	32.2 km	20 miles	32.2 km	20 miles	32.2 km
Turning Radius:	26.5 ft.	8.1 m	26.5 ft.	8.1 m	26.5 ft.	8.1 m	26.5 ft.	8.1 m

Notes 1) The data on this page applies to models without winch and optional accessories. Models with winch are impacted as follows: Payload: Reduce by 137 lbs. (62 kg); Curb Weight: Increase by 137 lbs. (62 kg); Length: Increase by 6 in. (152.4 mm). 2) Payload includes passengers, optional equipment, and trailer tongue weight. 3) Gross Combination Weight (GCW) of vehicle and trailer cannot exceed 14,800 lbs. (6,719 kg) for highway use only. A weight-carrying hitch gives your vehicle the capability to tow a maximum weight of 5,000 lbs. (2,270 kg). A weight-distributing hitch with spring bars gives your vehicle the capability to tow a maximum weight of up to 8,300 lbs. (3,765 kg). These are not necessarily weights the vehicle will tow at sustained highway speeds or varying altitudes. NOTE: The maximum allowable weight your vehicle can tow off-road, no matter what type of hitch is being used, is 5,000 lbs. (2,270 kg). 4) Optional, for emergency use only, a "get home" capability which will cause tire damage. Consult your local Hummer dealer for availability of accessories and current specifications. All specifications are based on latest information available at time of printing. Pictured vehicles may vary from actual production models. Manufacturer reserves the right to change prices, colors, materials, equipment, and specifications at any time and without prior notice. Details and specifications may vary according to local regulations and conditions. Some models may not be available at all times in all markets. See dealer for 3-year/36,000-mile warranty details. Copyright AM General, 1998. HUMMER®, HUMVEE®, TorqTrac 4™ (TT4), Hummer Genuine™ Accessories and the vehicle's grille design are registered trademarks of AM General Corporation.

Standard Equipment

- 4-Speed Automatic Transmission
- 4-Wheel ABS Power Disc Brakes
- Translucent Brake Fluid Reservoir with Level Sensor
- Auxiliary Fuel Tank
- Tachometer
- MT Tread Tires
- Utility Lighting Package
- Heat and Sound Insulation
- Halogen Headlights
- Aluminum Body
- Tonneau Cover (4-Passenger Models)
- 124 Amp Alternator
- Vertical Rear Doors (Wagon Model)
- Serpentine Drive Belt
- Flow-Through Ventilation
- Full-Time 4WD System
- Power Steering
- High-Back Bucket Seats
- 3-Point Seat Belts
- Padded Interior
- Power Door Locks (Including Wagon Rear Door)
- AM/FM Stereo w/Cassette
- Glove Box
- Geared Hubs
- EZ-Kool® Glass
- Driver and Front Passenger Seat Armrest
- Sliding Rear Window (2-Door and 4-Door models)
- Power Windows
- Air Conditioning with Auxiliary Rear Unit
- TorqTrac 4 (TT4)

Optional Equipment

- Central Tire Inflation System
- Trailer Towing System
- Driveline Protection
- Runflat Tire System
- Highway Touring Tires
- Tire Bead Lock System
- Black Vinyl Seats
- Power Mirrors
- Remote Keyless Entry
- Rocker Panel Protection
- Heated Windshield
- Deluxe Rearview Mirror
- Rear Window Defroster (2-Door and 4-Door models)
- Monsoon™ Premium Audio System w/CD Player/Changer
- Brush Guard
- 12,000 lb. Winch
- Body-Colored Wheels
- 10,800 lb. GVW

Components and Features

Turbo Diesel Engine :

Type : V8, 6.5L Diesel Turbocharged,
Electronically Controlled
Horsepower : (@ 3,400 rpm): 195 hp (145 kW)
Torque : (@ 1,800 rpm): 430 lb.-ft. (583 Nm)
Governor Type : Electronic
Displacement : 396 cu. in. (6.5L)
Bore and Stroke : 4.06 x 3.82 in. (10.3 x 9.7 cm)
Compression Ratio : 20.2:1
Maximum Speed : 83 mph (134 kph)
Typical Accel. : (0 to 60 mph) 18.0 sec.
Fording Depth : 30 in. (76.2 cm)
Fuel Capacity : 25 gal. (95L). Plus 17 gal. (64L) res.

Transmission : 4L80-E 4-speed automatic

Gear Ratios : 1st - 2.48:1, 2nd - 1.48:1,
3rd - 1.00:1, 4th - 0.75:1, Reverse - 2.08:1,
Torque Converter Ratio - 2.2:1
Transfer Case : New Venture Gear Model 242.
Gear Ratios : Low 2.72:1, High 1:1
Axles : Hypoid with a ratio of 2.56:1 Continuous
torque rating is 1,424 lb.-ft.
Geared Hubs : Gear Ratio - 1.92:1.
Frame : Steel Box section with 5 crossmembers
Electrical : 12 Volt 124 Amp - Alternator
Steering : Power assisted with a variable
ratio of 13/16:1

Differential : Zexel Torsen® II torque biasing differential

Brakes : Hydraulic actuated, four-wheel inboard
mounted Meritor-WABCO ABS power disc brakes
with translucent reservoir and level sensor. Rotors
are 10.5 in. (266 mm) in diameter with an effective
area of 17.4 sq. in. (112 sq. cm) each. Parking brake
manually activates rear service brakes.
Suspension : Independent double A-frame with
open-end coil springs and hydraulic shock absorbers
Tires : 37 x 12.50R-16.5 LT load range "D" Goodyear
Wrangler MT radial

Interior Colors



Sandstorm Cloth



Cloud Gray Cloth



Durable Black Vinyl

Exterior Colors



Candy Apple



Night Storm



Mesa Dusk



Black



Competition Yellow



Silver Metallic

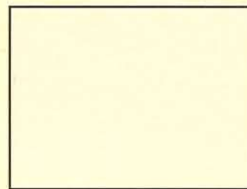

White



Bright White

Vehicle Models



4-Door Open Top



2-Door Hard Top



4-Door Hard Top



4-Door Wagon

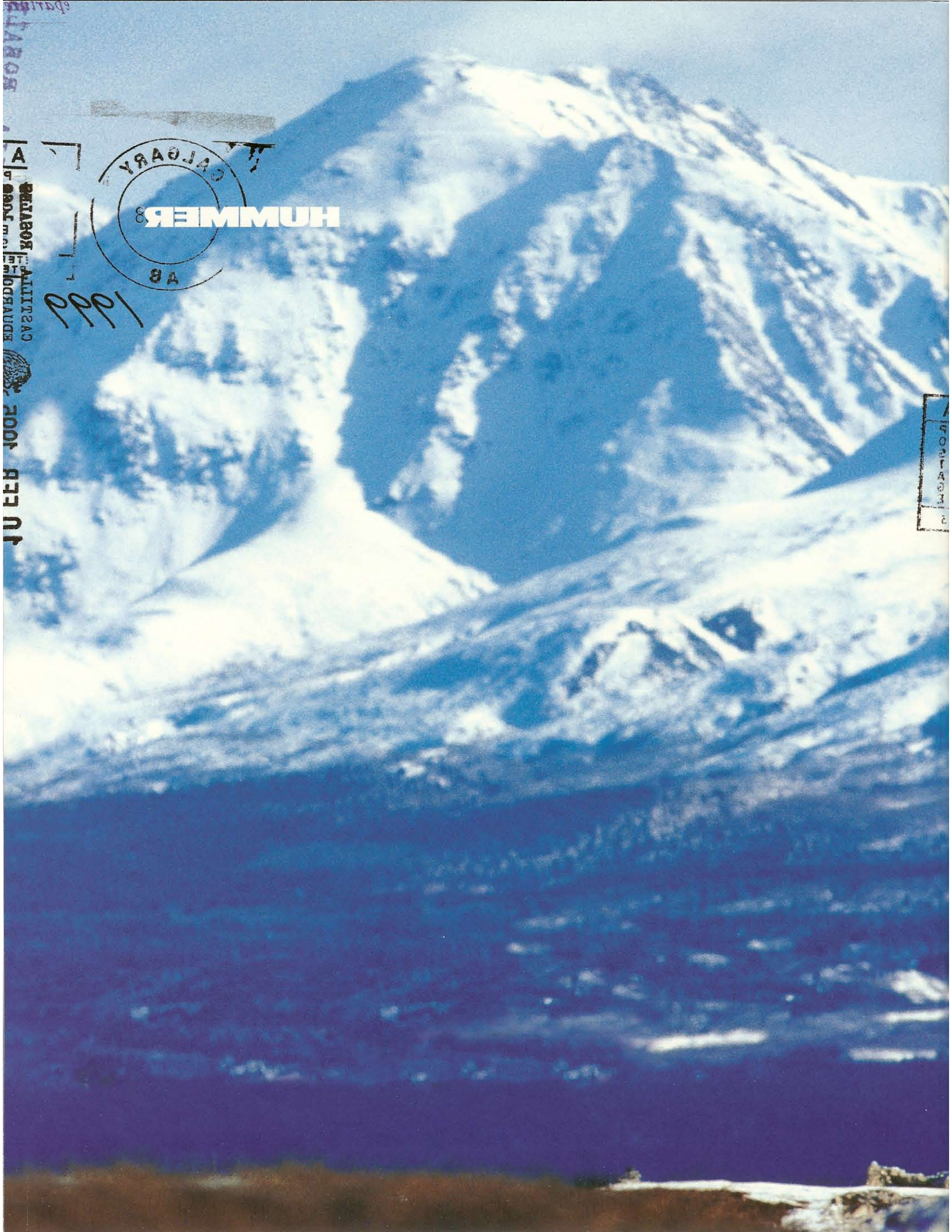

PHILIPSON
ALLITERAS
LOGRAVDE
2002
JULY 2002

CALGARY
8A

HUMMERS

1991

PHOTOGRAPH