

*Airflow*  
*Airflow*

C H R Y S L E R S

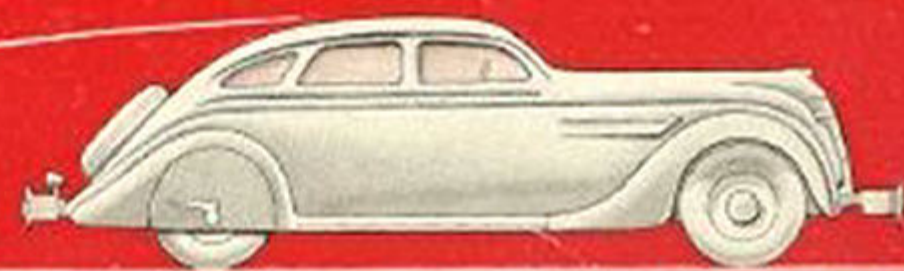











# Chrysler AIRFLOWS FOR 1935

★ ★ ★ ★ ★ ★

just one way to find out. A frank open letter was sent to every Airflow owner asking just two questions—How do you like your Airflow? Have you any suggestions for its improvement? They wanted the truth, so they didn't try to influence the replies.

Surely, no new motor car ever received such enthusiastic acclaim from its owners. Reproduced here are a few of the excerpts from the thousands of letters received. It was from letters like these, received from Airflow owners, that Chrysler engineers received many valuable suggestions. These, coupled with the past ten months of engineering experimentation, searching for refinements and improvements, have made possible the Great New Chrysler Airflows for 1935.



*From New York:*

"I have just reached the 5000-mile mark with my Airflow Chrysler, the last thousand miles took me through the mountains of New England. This was the first real opportunity I had for testing my car, and I am delighted. It has proven to be as far ahead in performance as in design. I would not know where

to turn to find a more outstanding unit of automotive transportation today."

(Signed) CONRAD THIBAULT



*From Indianapolis:*

"My new Airflow Chrysler is measuring up in every respect to my expectations. Further, this Airflow is so far advanced in the automobile industry that it will take the next two years for your competitors to catch up. This is the sixteenth Chrysler car I have purchased and it is the last word in riding,

and driving qualities. People who do not purchase this car are missing a treat of a lifetime."

(Signed) ANDREW C. SPAHR



*From Long Island:*

"I am more than delighted with the Airflow Chrysler in every way. It is my third Chrysler, each one of which I have nothing but praise. It's a treat to drive; my mother, seventy-eight years old, always reads now as we roll along the countryside. Gone are the jolts and bumps and she loves motoring now

as never before. We drove from Montauk Point and back, a distance of 227 miles from my home and return, using about 14 gallons of gasoline. This I consider truly remarkable."

(Signed) FLORA CROSBIE VICARS

*From New York:*

"It is the first sensible motor car since the invention of the automobile. You do not say half enough for its performance and comfort. I have ridden in the back seat at 80 miles per hour and have been able to write with perfect ease."

(Signed)

ALEXANDER WOOLLCOTT

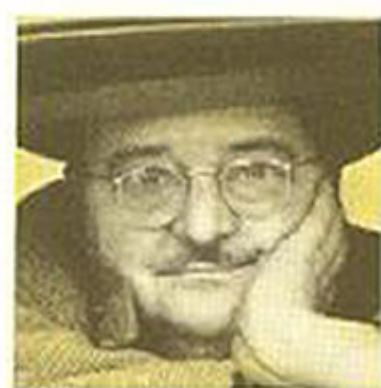

*From Portland, Oregon:*

"We are simply enraptured with our Airflow. The very moment Mrs. Skewes saw it on display we made up our minds to own it. And to think that I am over 60 years of age and this is the first car I have ever owned. We retired from business seven years ago and have done considerable traveling by train because

while we looked at many cars they didn't seem to suit. On our last trip of 4500 miles, the Airflow averaged a trifle over 16 miles to the gallon. It was a marvel to us for we have never experienced such comfort. The car has so much room and it rides without a jar."

(Signed) MR. AND MRS. C. H. SKEWES



*From Minneapolis:*

"The day after we took delivery on the new Airflow Chrysler, Mrs. Hussey and I started for an extensive trip which included Florida. We put over 6000 miles on the car while on this trip. Both Mrs. Hussey and myself have been amazed at the ease of handling of the car in a high wind, and the riding

qualities are beyond comparison. At one stage of our journey in the south, Mrs. Hussey wished to sew a ribbon on her hat. We were traversing an uneven tar-macadam road at the time, and it even surprised me when she threaded her needle without my slackening the speed."

(Signed) E. F. HUSSEY

*From New York:*

"I have just returned from Europe completing 7000 miles through France, Germany, Switzerland, Italy, Austria, and Hungary, with no trouble whatsoever. As you undoubtedly know there are long straight stretches of road in Europe known as express highways where speed is unlimited and the sky is the limit. With long runs of 25 to 50 miles in prospect it is possible to do some really serious driving and without any particular difficulty I was able to get about 91 miles an hour out of my car in conventional gear and in Overdrive in the neighborhood of 100 miles an hour."

(Signed) J. G. DAVIDSON, M. D.





# Inspired by one hundred million miles of Airflow Satisfaction...THE GREAT NEW



*From Los Angeles:*

"I have just returned from a 4500-mile trip through the Western National Parks. On this trip we encountered every type of road imaginable, yet despite this condition averaged 14-2/10 miles per gallon of gas. My opinion is without any question that it is the finest riding and driving car on the

market today. When I first purchased the car the popular comment was that they did not like the looks of the body design but I can assure you that this re-action is changing rapidly and 95 per cent of the people that I talk to have changed their opinion."

(Signed) W. A. WILGUS

*From Minneapolis:*

"My present Airflow is the eighth Chrysler that I have owned in the past nine years, and for some reason or other each one seems to be more satisfactory than the previous. I have traveled approximately 450,000 miles in this period and the Airflow in every respect is the most satisfactory car I have ever



driven. Recently, I drove it over 400 miles in an afternoon and evening and did not feel the effects of the trip at all. Its riding qualities are perfect. It has all the power and speed that anybody wants and I am looking forward to enjoying it very much. One thing that is especially interesting about it is the comfort with which the people in the back seat ride. There is not that worry about jarring them or bumping their heads against the top that we had with the old type car. Everyone who rides with me agrees that the Chrysler Airflow reaches about as near perfection in an automobile as we have ever seen."

(Signed) G. B. BAUDER

*From Chicago:*

"Our whole family is very much in love with the car. Mrs. Gillies and my 18-year old son and myself left for a trip down through New England covering 3800 miles. This gave us a very good opportunity to test the car both for performance and comfort. We found it far above our expectations in every respect.

From the point of economy of operation I am almost unable to believe my own evidence. During the trip we averaged between 15 and 16 miles per gallon and this covered all types of roads and driving. This trip was made during the hottest summer weather and we used no water and the only oil consumed was that which we used on drains. You certainly have produced a marvelous automobile."

(Signed) JAMES P. GILLES



*From Matawan:*

"I have just returned from California covering a distance of 3146 miles in four and one-half days, daylight driving time. On the trip out to California from New Jersey I made a distance of 3456 miles in six and one-half days driving time. The speedometer now registers 13,800 miles, and I have been

entirely satisfied with its performance. In fact, it is the most satisfactory car that I have ever owned regardless of price. One of the most remarkable things that I have experienced with the car is the fact that though I have driven across several deserts in parts of the country where the temperature registered from 110 to 120 degrees, and my speed was up around 70 miles during the crossing, I have put less than a teacupful of water in the radiator since it was delivered."

(Signed) ROSS B. FOUNTAIN



\* \* \* \* \*

**T**HOUSANDS upon thousands of enthusiastic Airflow owners who have driven their cars in excess of one hundred million miles in the short period of one year have furnished the inspiration for the Great New Chrysler Airflows for 1935.

Chrysler engineers with their characteristic thoroughness had spent five years of continuous research and experimentation to produce this greatest of all advancements in personal transportation—the Airflow—but still they were not satisfied. They realized fully well that all testing and driving had been done by factory experts. What would be the reaction to this great new car in the hands of its thousands of owners? There was

*From St. Louis:*

"Our recent trip from St. Louis to Cape Cod was the easiest and most enjoyable we ever made in a motor car. It took us three days to drive the 1400 miles and never once did we experience any trouble or become the least bit tired. It was only through the remarkable efficiency of our hydraulic brakes



that we averted striking a child, who ran into our path. We cannot speak too highly of our Airflow Chrysler."

(Signed) MRS. MORGAN DAY



*From Cincinnati:*

"While I have never written before about cars purchased I feel that I want to do so in this case because the car has given us such complete satisfaction. A little over a month ago Mrs. Hutton used this car in making a trip to Charlottesville, Virginia, and on her return trip told me that she had

never ridden in a car that was more comfortable and satisfactory."

(Signed) J. M. HUTTON



# AN Amazing Triumph FOR

## ★ IN SAFETY

Chrysler engineers have steadfastly maintained that Airflow construction with its girder-trussed frame, designed like a bridge, with longitudinal, vertical and diagonal girders extending from the extreme front of the hood up and through the top of the all-steel body to the rear was the safest and most rigid ever built.

A search was made to find about the worst condition to which a car could be subjected. An old stone quarry in the hills of Pennsylvania was finally selected. A stock Airflow Chrysler was deliberately run over this 110-foot cliff rolling end over end with such impact that an ordinary car would have been literally battered to pieces. The Airflow withstood this terrific punishment and landed on all four wheels in the shale at the bottom and drove away under its own power.

*"An actual recorded photograph reproduced from the Chrysler film 'Safety With A Thrill.'"*

## ★ IN

A stock Airflow Chrysler Imperial Coupe established 72 new stock car speed records in a recent 24-hour run at Great Salt Desert, Utah, under the supervision of the American Automobile Association Contest Board.

These records were made under the most trying conditions, yet the Airflow functioned perfectly. Heat for the better part of the run hovered around 105 degrees—the burning sun reflecting on the marble white sand caused mirages and reflections that made driving difficult. Yet with all these handicaps the Airflow was able to establish a record never before

*"Views of the record breaking speed run made on bed of*





# AIRFLOW DESIGN

## SPEED

attained by any car regardless of price or piston displacement.

The Airflow recorded 95.7 m.p.h. for 1 mile—90.04 m.p.h. for 500 miles and 84.43 m.p.h. for 24 hours, covering a distance of 2,026,405 miles.

Thirty-five of the records established are in the Unlimited Stock Car class which includes cars of any piston displacement. Thirty-seven of the records are in Class B, which includes cars of from 304 to 488 cubic inches piston displacement and in which the Airflow Imperial is listed with 323.5 cubic inches.

*the Great Salt Desert, in Utah.*



## ★ IN ECONOMY

After the speed run the same stock Airflow Chrysler Imperial Coupe was driven from Los Angeles to New York and made the astonishing economy record of 18.152 miles per gallon at an average speed of 41.358 miles per hour.

In all the records of motoring there has never been a car to equal the achievements of the Airflow Chrysler. It takes advanced engineering to produce a single body structure from head lamps to tail lamps—it takes power and stamina to break 72 speed records—it takes a new kind of design to establish such amazing economy.

There could be no more sweeping triumph for the principles of aerodynamic design than have herein been presented—each is of vital importance when making your choice of personal transportation.

*\*Los Angeles city officials start the Airflow on its run across the continent and at the finish Harry Hartz receiving the congratulations of Mr. W. P. Chrysler on the Airflow's great performance.*

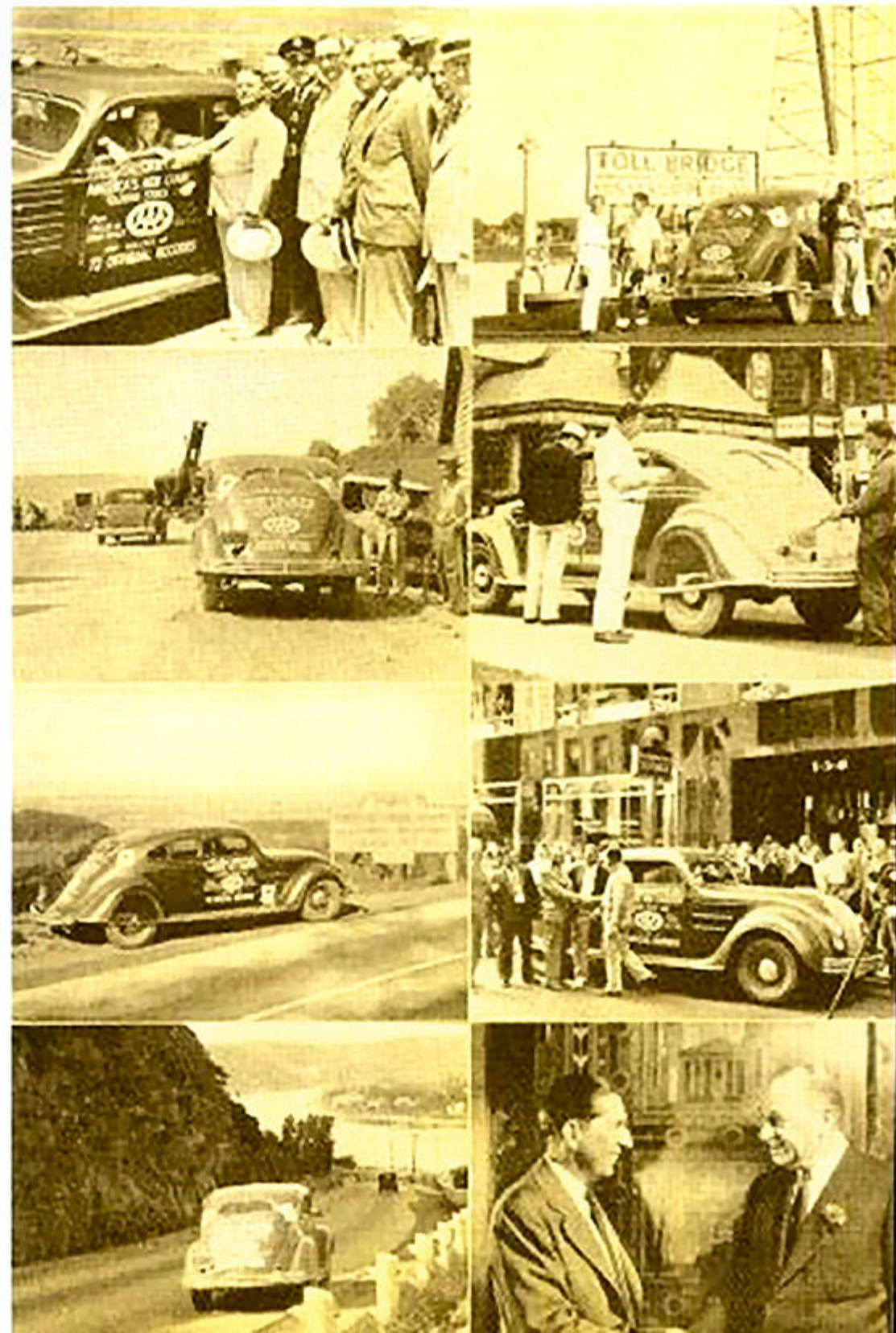





# Experience the sensation of FLOATING RIDE *with* FLOATING POWER

*\*Chrysler spring action is attuned to the gait of your normal walk which is about 90 to 100 steps per minute. Any increase of this cycle causes fatigue.*



After you have taken your first ride in an Airflow Chrysler you will appreciate the fact that Airflow is more than a new style.

For into these new Chryslers for 1935, Chrysler has engineered an even finer ride than was obtainable in the first Airflow.

Imagine a ride in which no motor vibrations reach the occupants—a ride over the roughest roads, yet

so true to \*normal human periodicity is the action of Chrysler's new type tapered springs, that you are able to relax completely and arrive at your destination, even though it be a distance of several hundred miles, fresh and rested.

New springs with many more leaves that permit quick flexing on little jolts and controlled flexing on big ones, however, is only a small part of the story. With Airflow design it has been possible to move the motor weight mass forward over the front axle, locating new pivoting points which makes front and rear spring

action entirely independent of each other.

By moving the weight mass forward Chrysler engineers were able to move the rear seat forward a full 20 inches, cradling all passengers between the wheels inside the rigid bridge type frame at the point of minimum perpendicular movement. Much of Chrysler's vibrationless ride is due to its patented Floating Power rubber engine mountings, which allow the motor to rock in perfect balance, and dissipate all vibration without carrying it through the frame members to occupants of the car. We strongly urge you to experience this sensational ride for yourself, for only then can you have a complete understanding of its remarkable comfort.

*Note the turbulence in the glass of water on the motor while the water in the glass on the fender is stationary. That's the effect of Floating Power rubber engine mountings. Motor vibrations are confined to the motor and do not reach the car structure.*

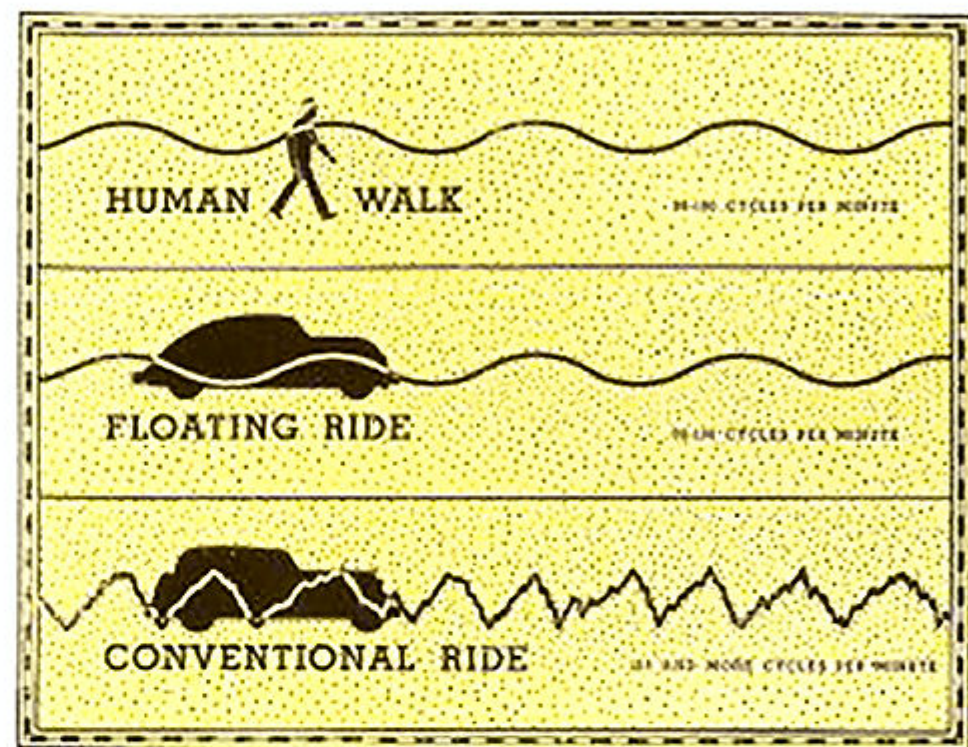

*Scientists have proved that rhythms which are similar to walking are pleasant to the body. Discordant rhythms cause quick fatigue. That is why spring action in the Airflow Chrysler is identical to the rhythm of your walk and you can ride astonishing distances without fatigue.*

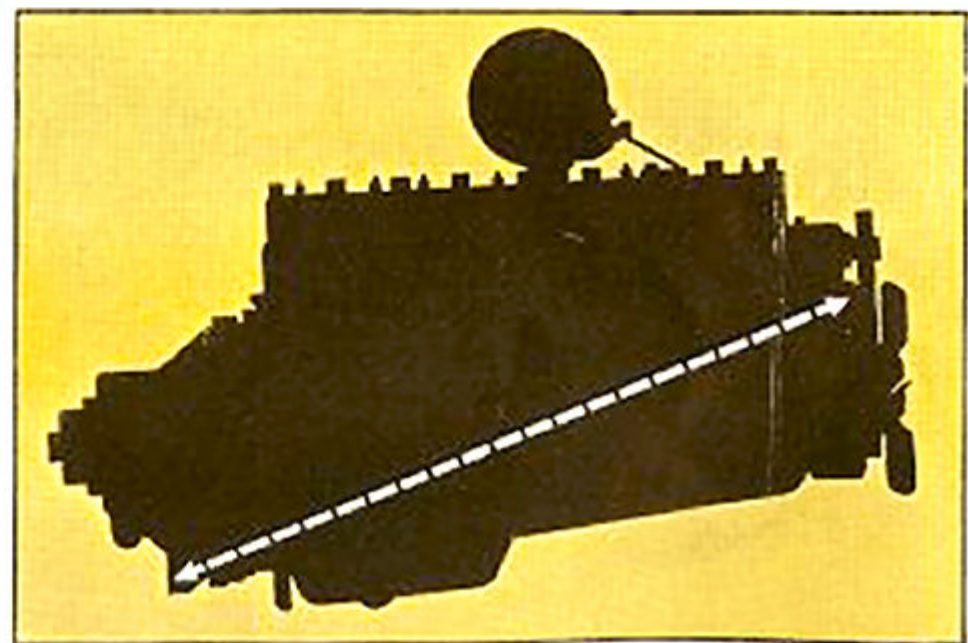

*Floating Power rubber engine mountings suspend the motor in perfect balance, allowing it to rock on its axis and dissipate its power impulses without transmitting them through the frame to car occupants.*

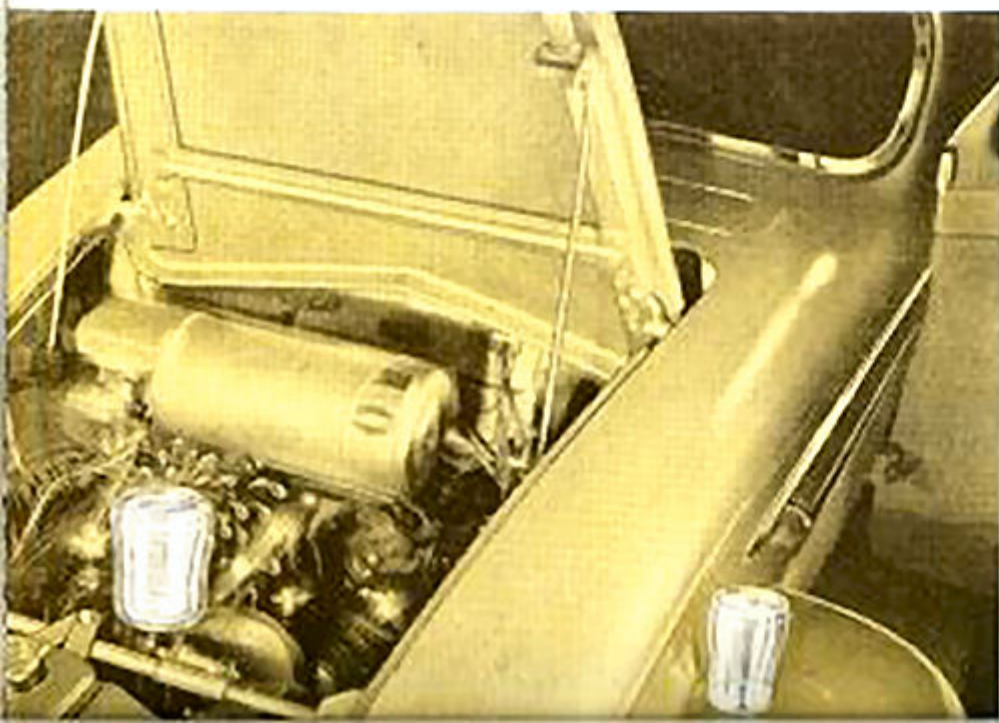



# YOU RIDE *Inside* THE FRAME

OWNERS and occupants of the Airflow Chrysler enjoy a new degree of security and safety, for aside from giving the car an easy projectile-like entrance through the air, Airflow design has made possible a new type frame construction. In the Airflow Chrysler you actually ride inside the frame. The entire structure, body and frame, is one complete unit. Structural steel girders are built into the body of the car, starting from the extreme



front end of the hood running up over the springs, through the top of the body and back down at the rear. Other girders form the lower structure with vertical and diagonal units joining and reinforcing the upper and lower members. Structural members and sheets of heavy gauge steel are welded together to form the outside of the body, making the body and frame one. The result of this new construction is the safest and most rigid car built.

*You ride inside the frame with part of the frame over your head.*



*Passengers are cradled between the wheels at the point of minimum perpendicular action.*



*Sheets of heavy gauge steel and structural members are welded together making body and frame one.*

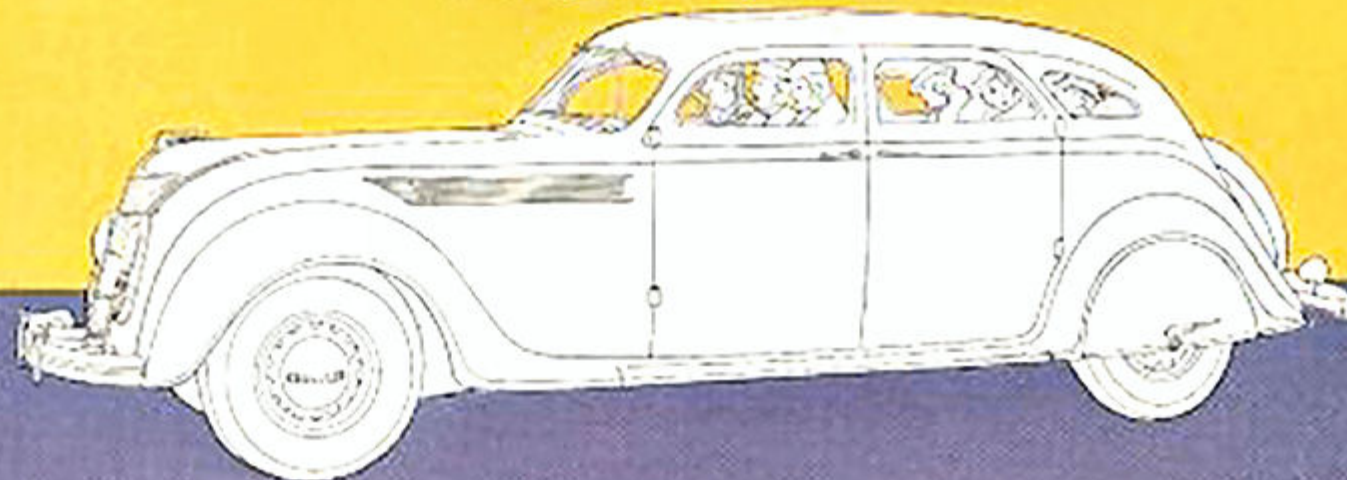







# THE AIRFLOW *Chryslers* FOR 1935



For sheer beauty of line and appointments the new Airflow Chrysler Eight and Imperial are without a par on the highways. There is a perfect union of science and art in the new Airflow radiator design . . . the new hood lines that flow gracefully backward allowing the car an easy entrance through the air . . . the new louvre design with its sparkling chromium fins . . . the new headlight treatment with horns mounted directly beneath, in the body out of sight . . . the beautiful new radiator grille . . . new type bumpers and guards . . . the sweeping lines of the fenders . . . the sloping, tapering rear end. All the modern features which caused



such profound excitement last year have been retained — many of them greatly improved and enhanced — yet through each change there has been maintained a strict adherence to the true fundamentals of Airflow design. On the Airflow Eight chassis there are three body styles available, the six-passenger sedan — the six-passenger coupe — the business coupe seating three passengers on the front seat, which can be augmented with a removable rear seat, seating three additional passengers when the rear compartment is not used for luggage. Two body styles are available on the Airflow Imperial chassis—the six-passenger sedan and six-passenger coupe.



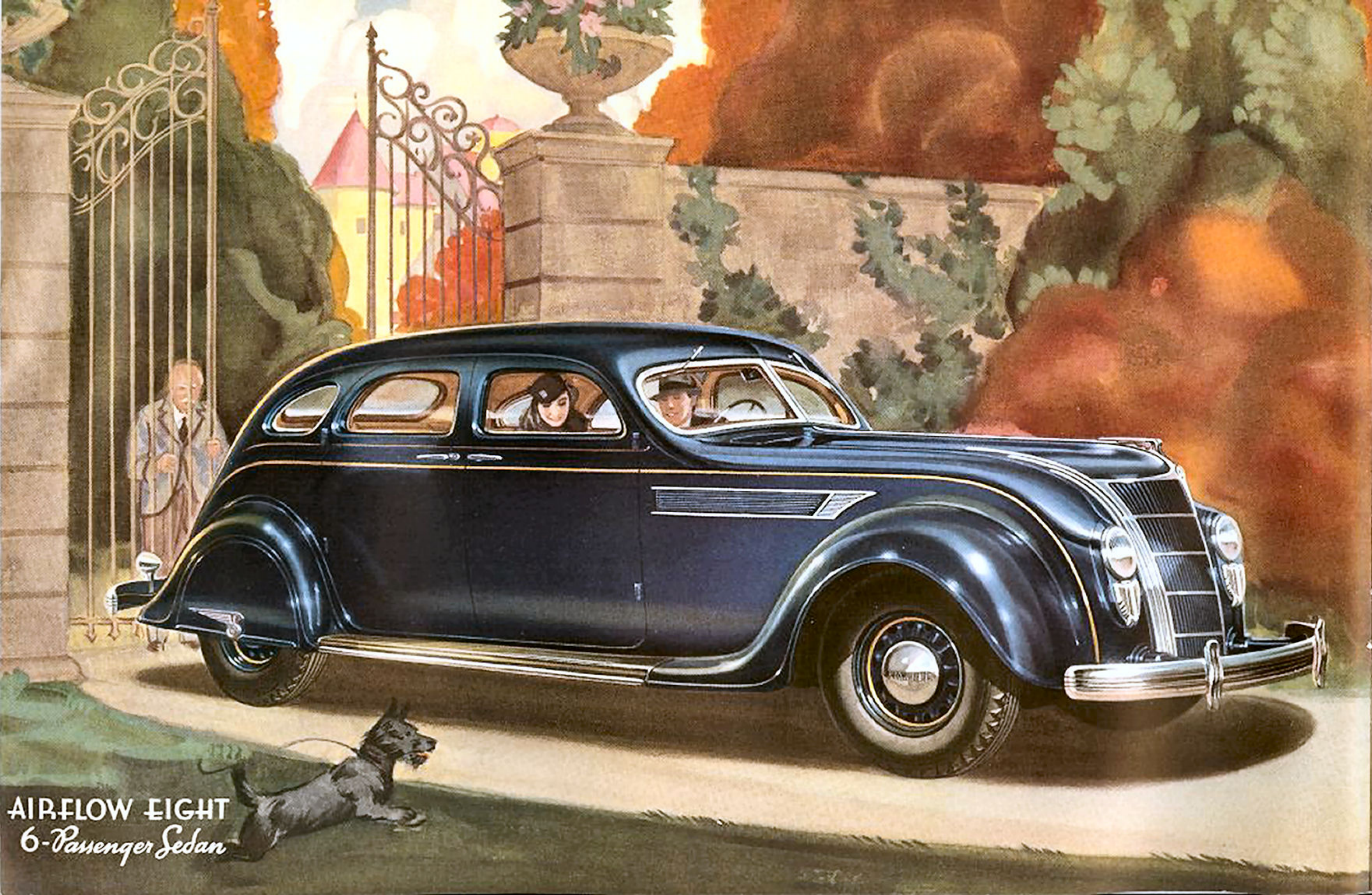

AIRFLOW EIGHT  
*6-Passenger Sedan*



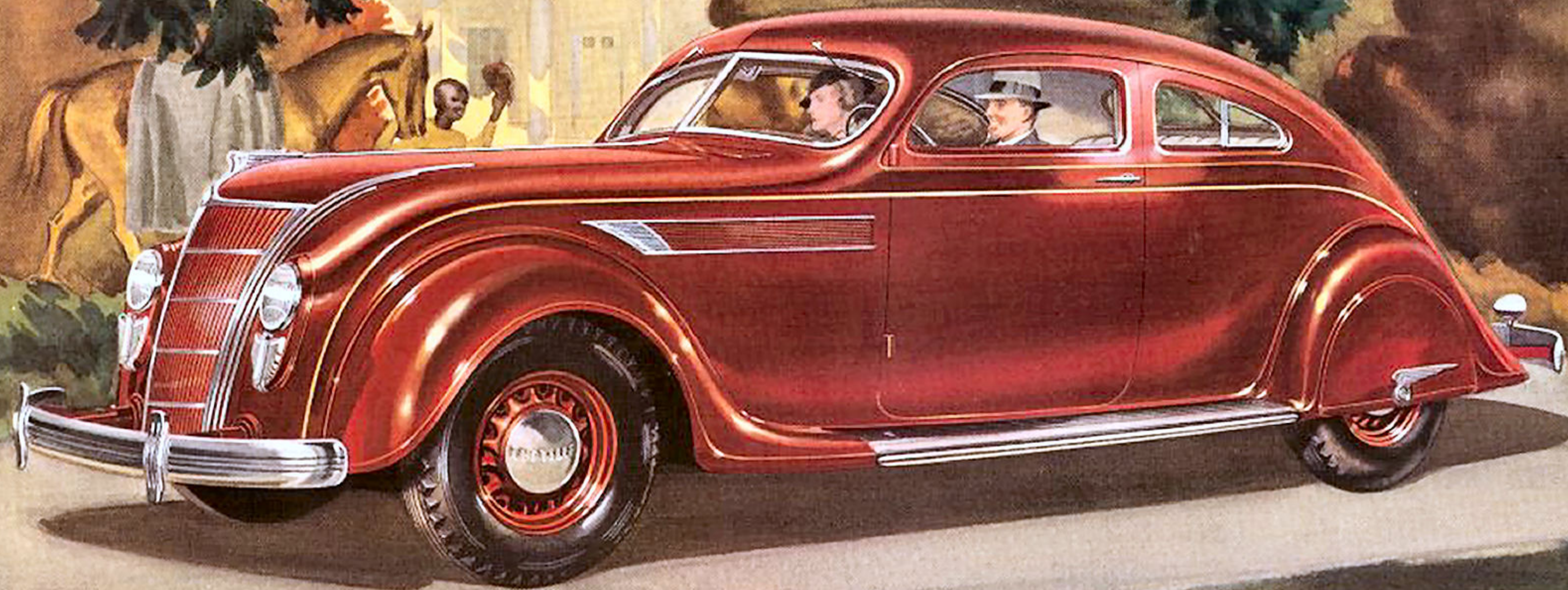

AIRFLOW EIGHT  
*6-Passenger Coupe*



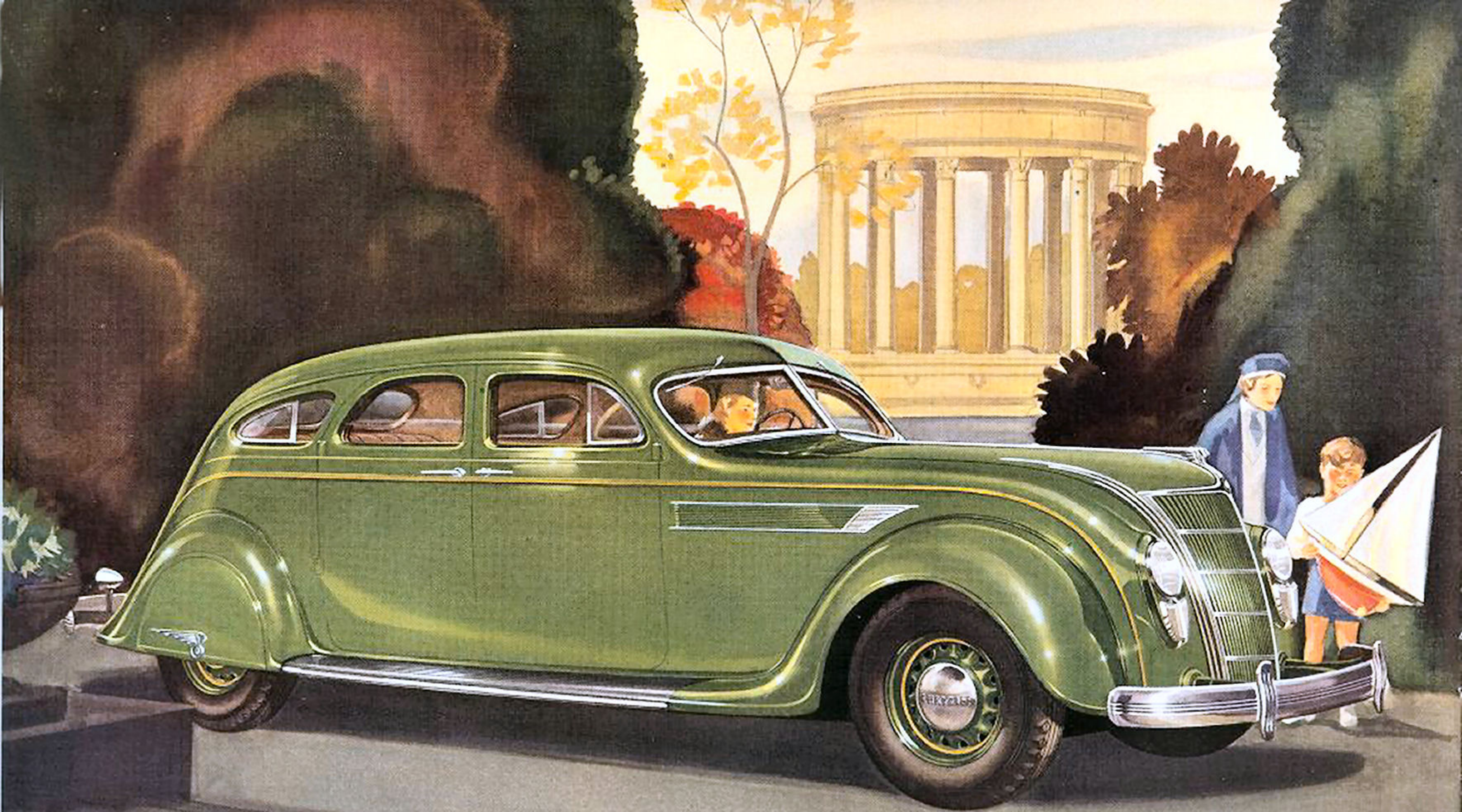

AIRFLOW IMPERIAL  
*6-Passenger Sedan*





AIRFLOW IMPERIAL  
*6-Passenger Coupe*



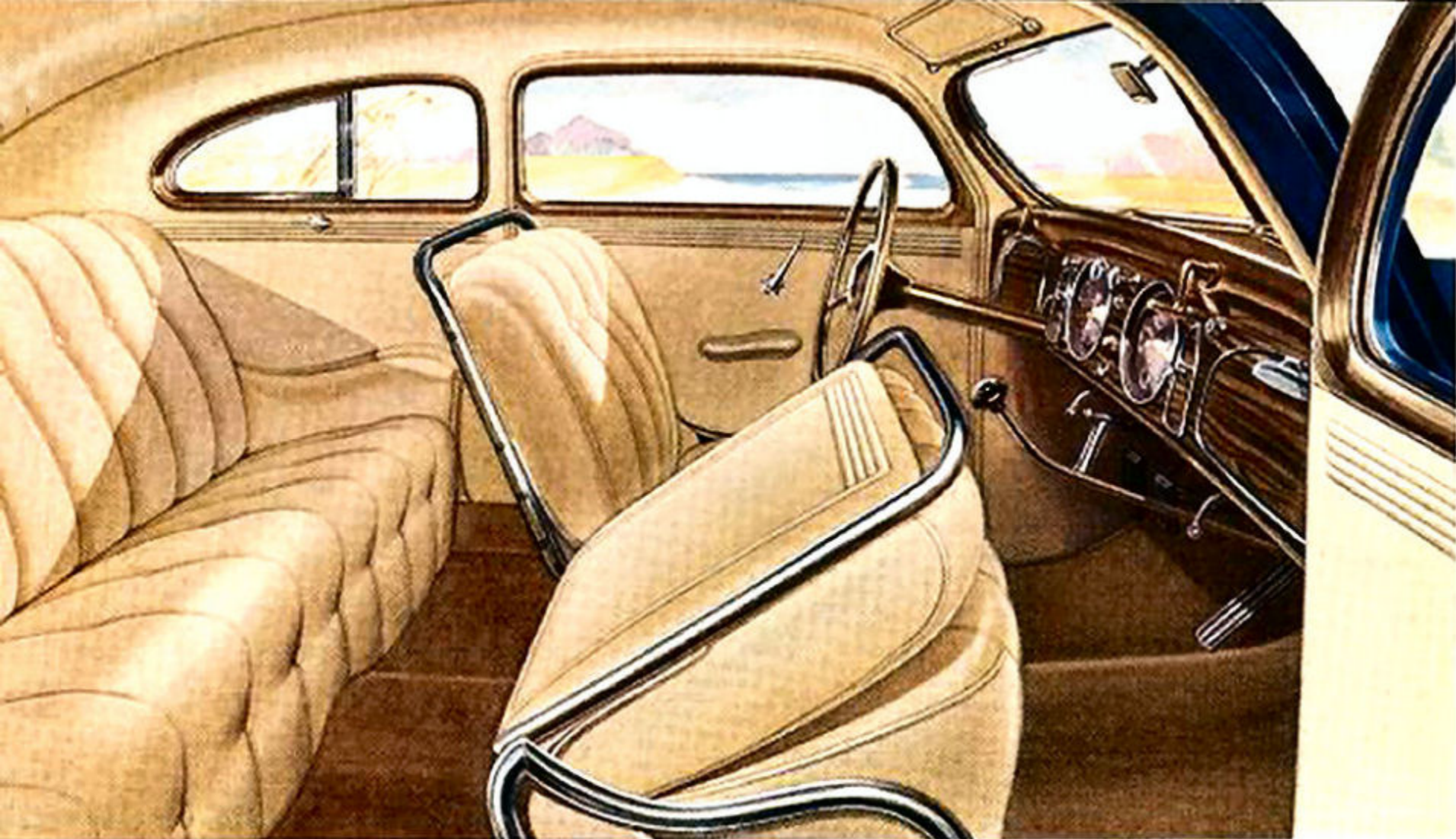

*Interior Six-Passenger Coupe*

# DRAWING ROOM

A new sense and appreciation of what luxury really is, is immediately apparent upon inspection of these superb new interiors . . . yet in the design of every detail maximum utility has been given full consideration along with comfort. Seats are as wide and as deeply cushioned as divans—doors as wide as those in your home—there is ample leg room for complete

*Interior Six-P*

Left—For the convenience of rear seat passengers there is a removable ash tray located in the center of the front seat back of sedan models. There are also two ash receivers on the dash for front seat passengers.

Left below—A slight turn on the rear window regulators allows the window to pivot, permitting rear seat occupants to select the degree of ventilation desired.

Below—Front seats are adjustable forward and backward by a light upward lift on the control on the driver's side of the front seat.

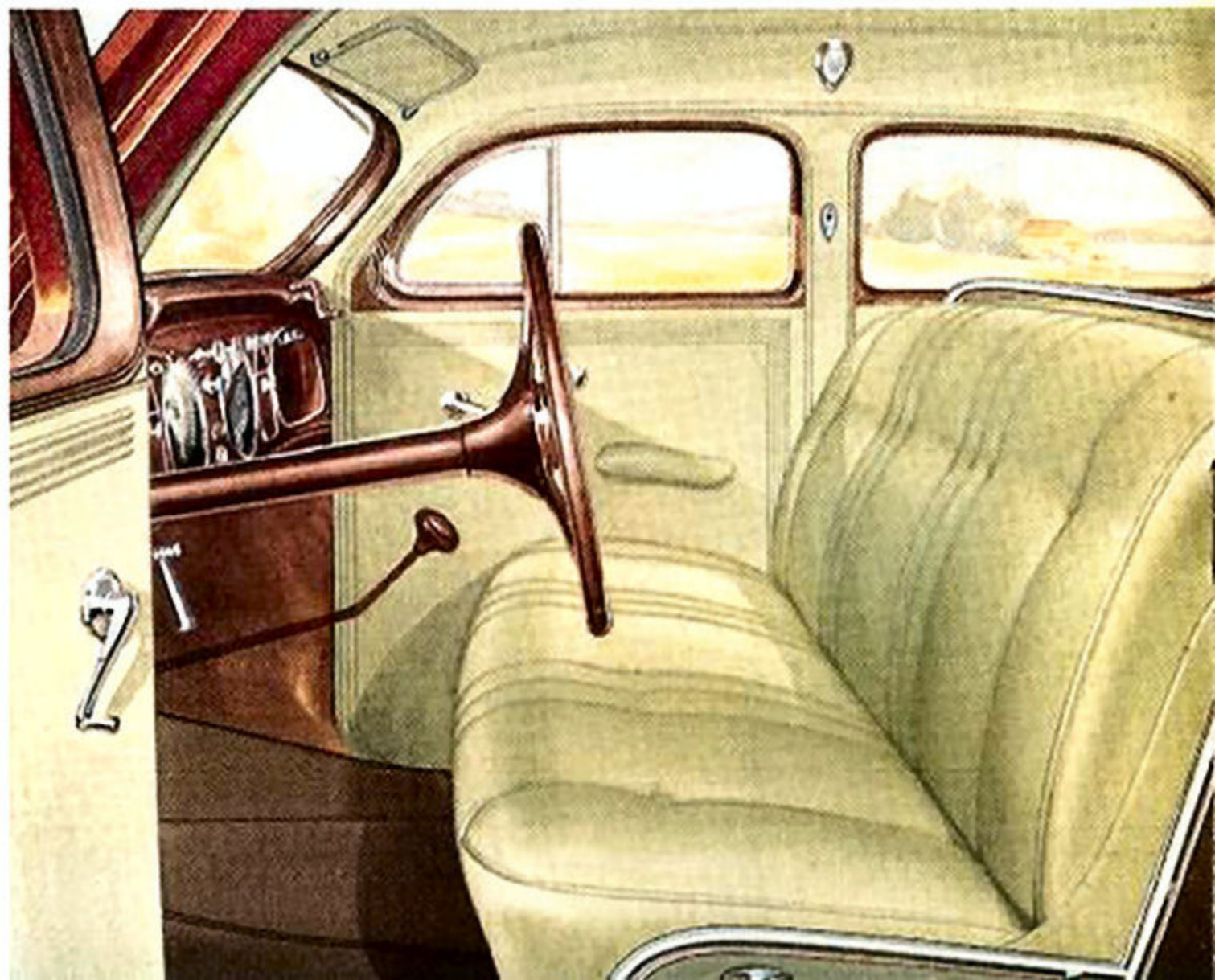



# Luxury . . .

relaxation—a luggage compartment behind the rear seat back—a carrying space in the rear compartment of the business coupe equal to that of a dray and a host of other interior refinements and advantages made possible by Airflow design. Features such as these should have your careful consideration before making the purchase of any motor car.

Passenger Sedan

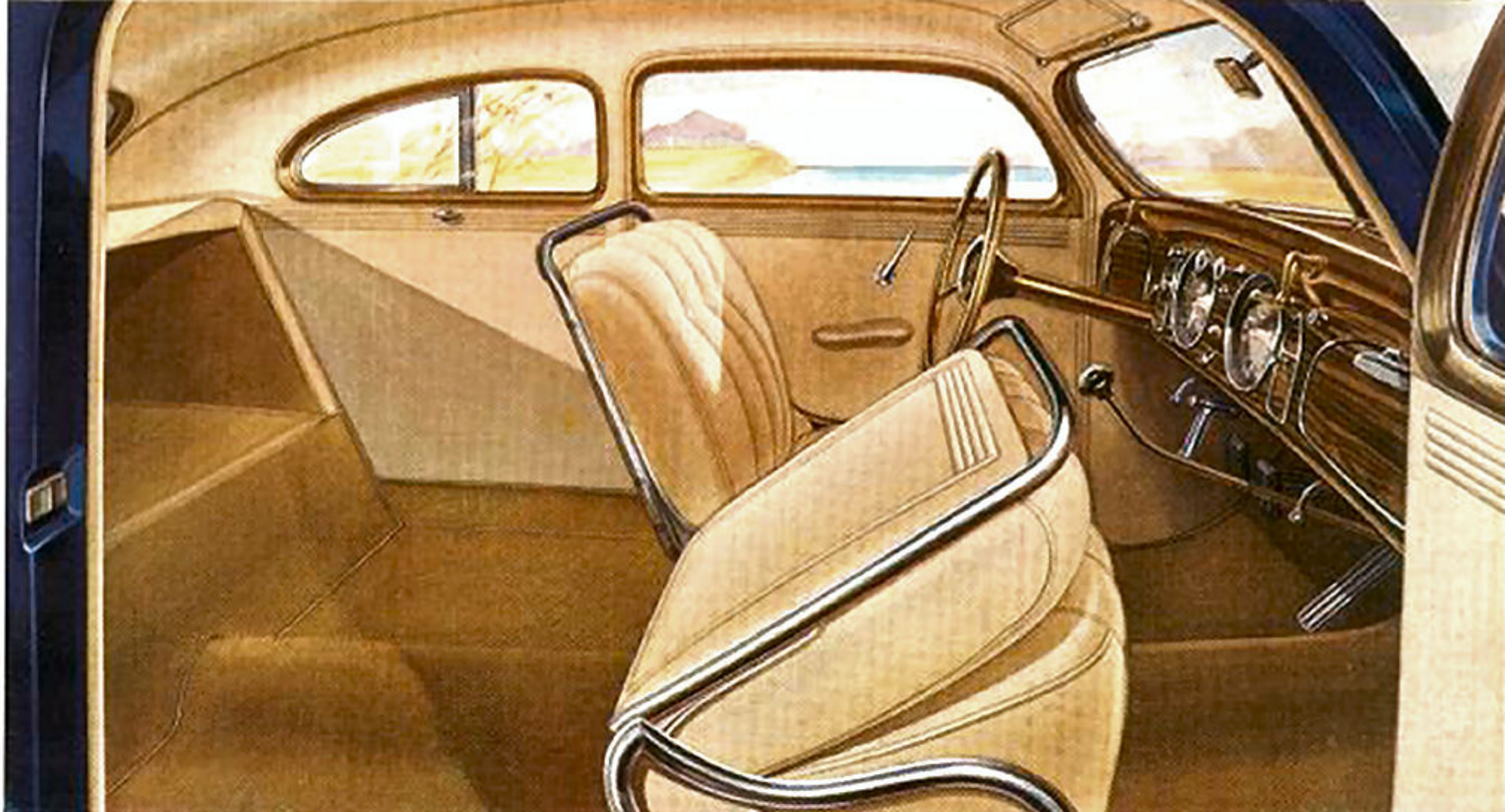
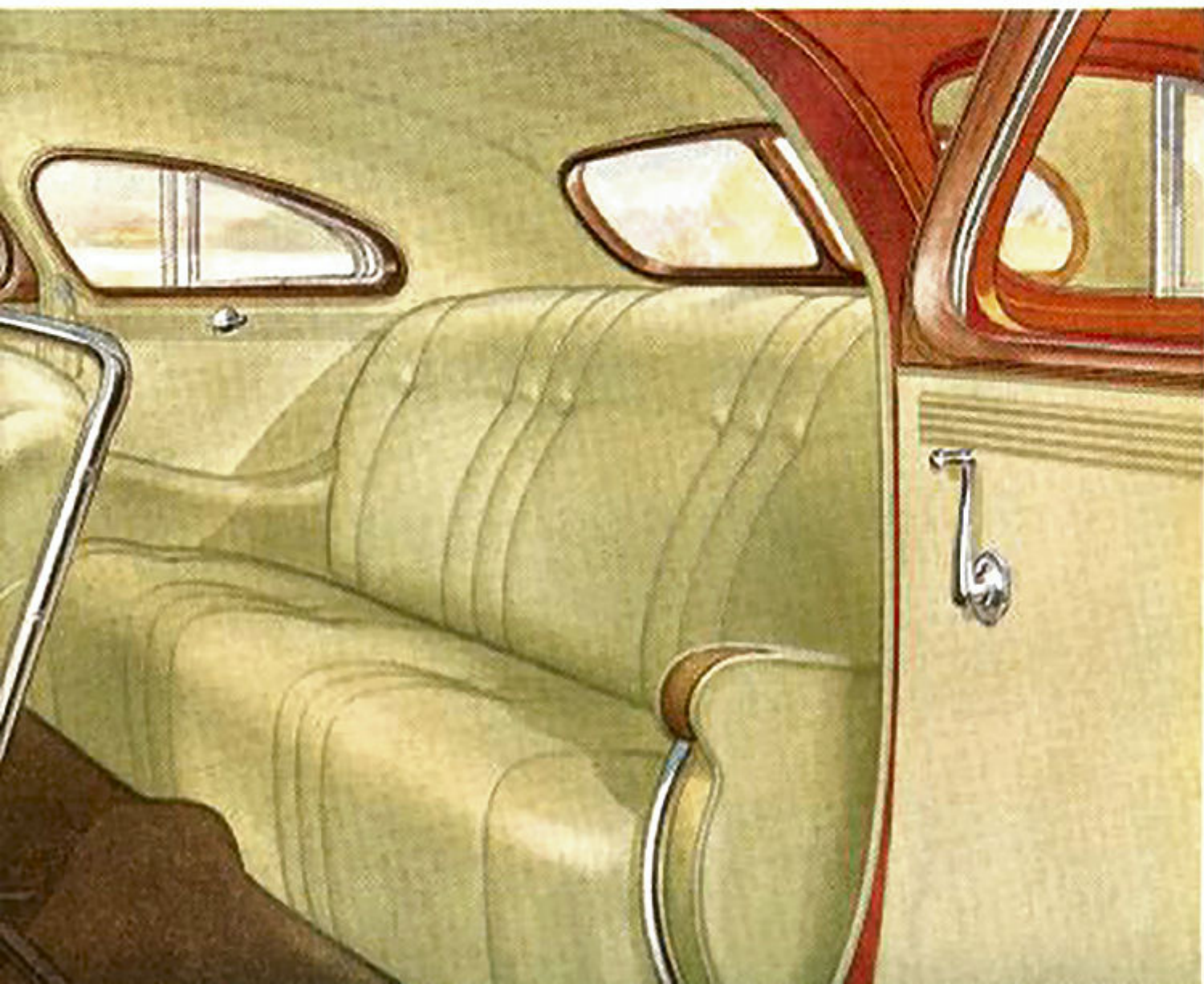

Interior Business Coupe

Right—Luggage is stored inside out of the dust and weather in the Airflow Chrysler leaving the floor space in the rear compartment free of obstruction.

Below—The instrument panel and controls of the Airflow Chrysler are equal in trimness and accessibility to those of a smart racing yacht. Dials are large aeroplane type grouped in the center for easy visibility. Two ash receivers are located on either side of the dials. When a radio is specified the right receiver is removed and is replaced by the radio dial. Two glove compartments, one on each end of the panel, round out the dash appointments.

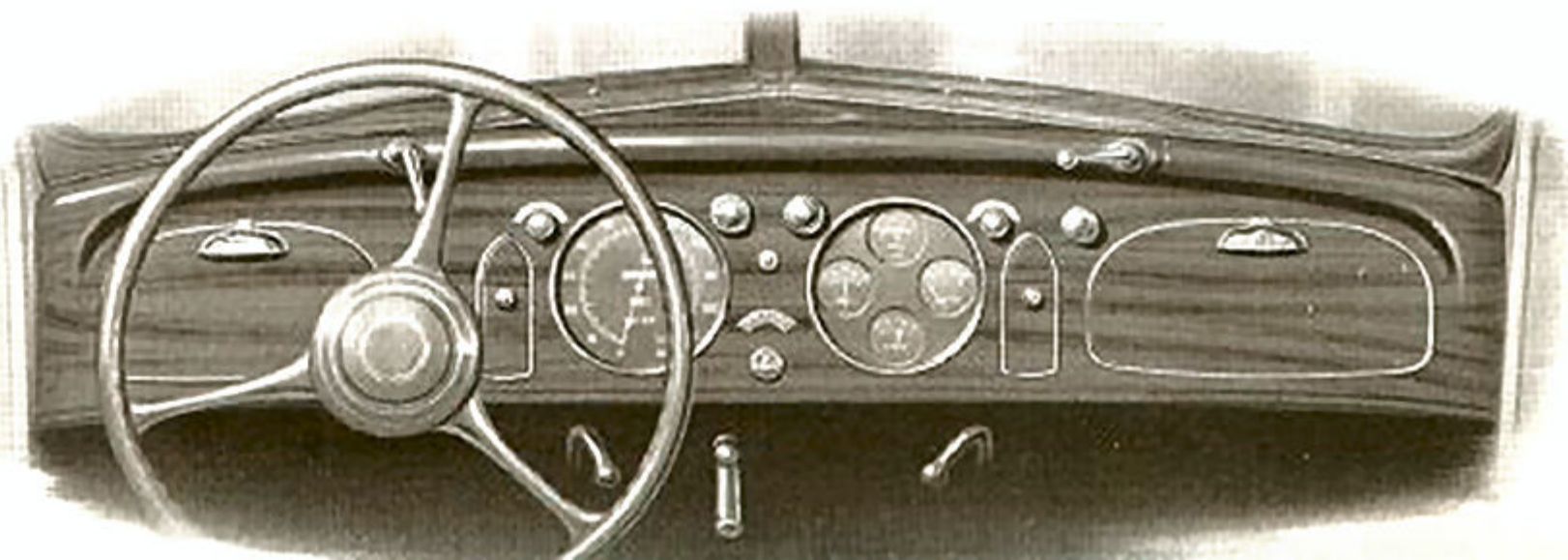



# AIRFLOW *Chrysler Custom* IMPERIALS

130 HORSEPOWER

137 INCH WHEELBASE

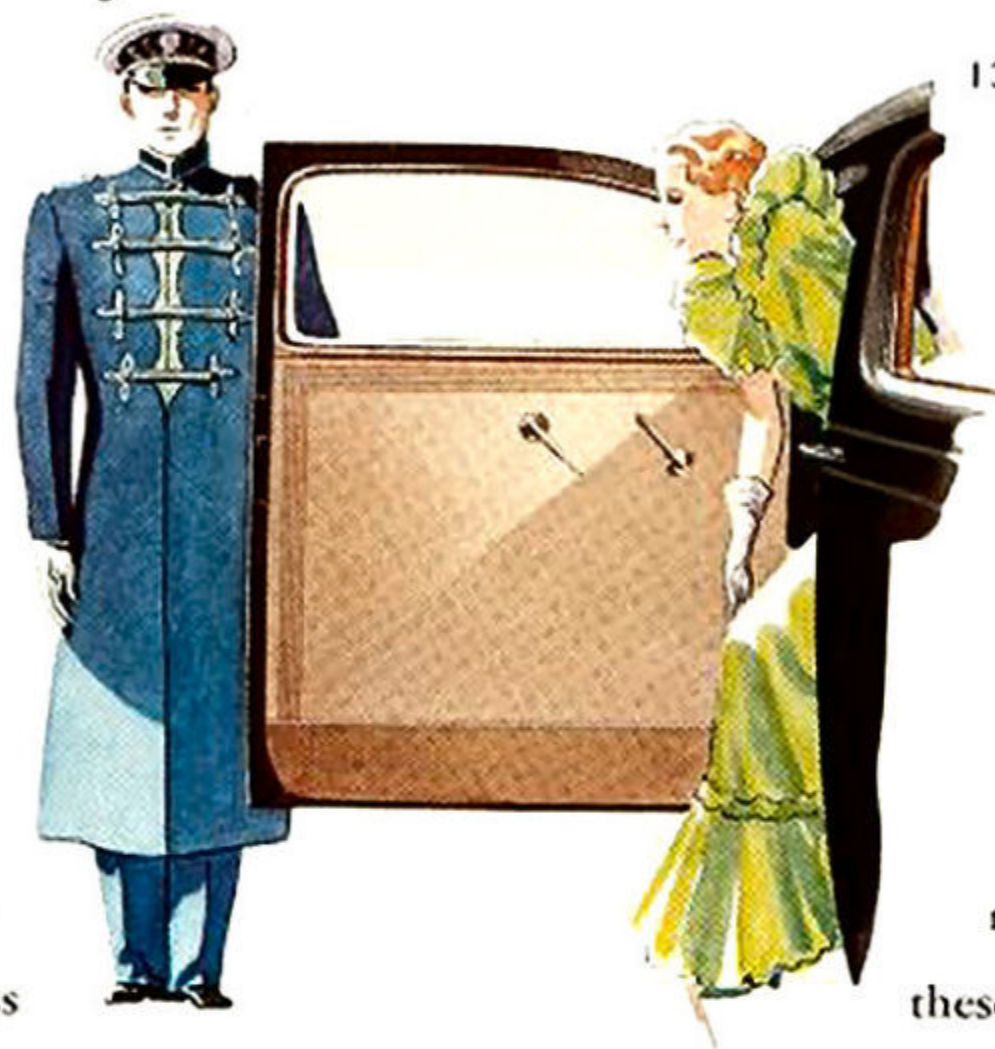

In the building of the new Airflow Custom Imperials for 1935, Chrysler engineers show the results of their ceaseless efforts to bring to light those pleasing notes of smartness and distinctiveness long associated with the best custom building practices used both here and abroad.

Endowed, as are these new Custom Imperials, with the greatest group of engineering developments of modern times—the all-steel unit body and frame—Floating Power rubber engine mountings—easy acting hydraulic brakes—syncro-silent transmission and a

multitude of other refinements—there is little wonder that unparalleled smoothness and ease of operation result. Combine these things with Chrysler's flawless execution of interior styling and matchless Floating Ride, and there is provided for those whose tastes lean to the better things of life—the ultimate in personal transportation.

There is a choice of two body styles on the 137-inch wheelbase—the Sedan for six passengers and the Sedan Limousine—both bodies are by Le Baron.



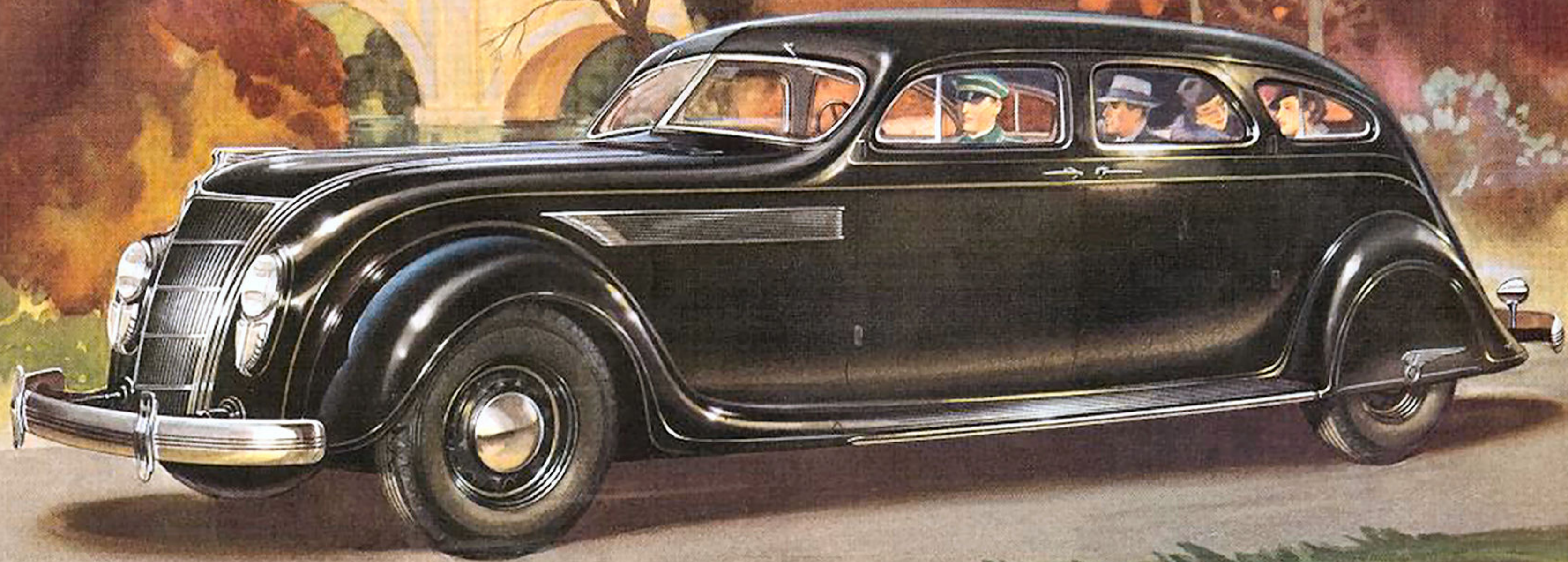

**AIRFLOW CUSTOM IMPERIAL**  
*8-Passenger Sedan Limousine*



# THE *Smart Atmosphere*

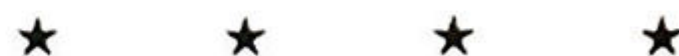
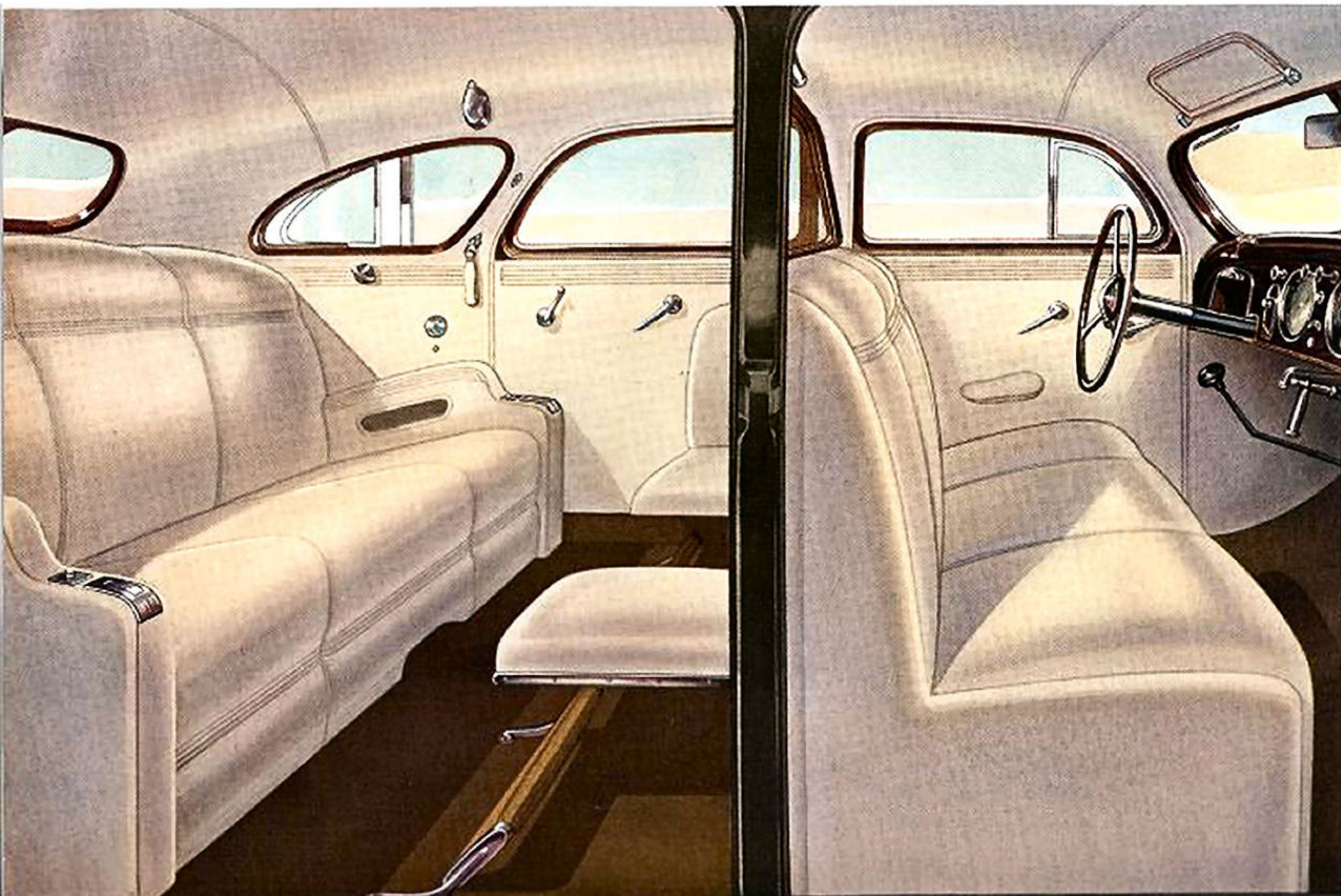

Masterful designing with its accompanying luxury were never more apparent than in these Custom Imperial interiors by Le Baron—every turn will reveal innumerable touches that pronounce them as possessing striking individuality and charm.

Upholstery is of the finest fabrics, with a softer, richer treatment of cushions, side and roof—appointments and hardware are undeniably in keeping with the 1935 version of modern decoration. In all, if there is a choice to be made it must be from the standpoint of the function of the car—so alike are they in detail.



# OF A MODERN PENTHOUSE . . . .



*Entrance to the rear compartment and auxiliary seats is made through doors as wide as those in your home.*

In the Sedan Limousine—the divisional glass partition between the front and rear compartments may be raised for privacy when the car is chauffeur-driven, or lowered when owner-

driven to give the informal appearance of a sedan. When the car is chauffeur-driven, communication between the tonneau and the driver's compartment may be carried on through the dictaphone located on the left side of the rear compartment just above the arm rest. A convenient control handle for raising or lowering the divisional glass partition, is located in the back of the front seat within easy reach of the rear seat occupants.

For those who prefer to do their own driving the six passenger Sedan provides an ultra smart car of outstanding beauty and surpassing style. Interiors are in the mode of the smart modern club car—with a freshness that is not only restful to gaze upon but wherein every possible advantage has been taken of the extra long wheelbase to provide the traditional comforts and safety—possible only in Airflow design and construction.

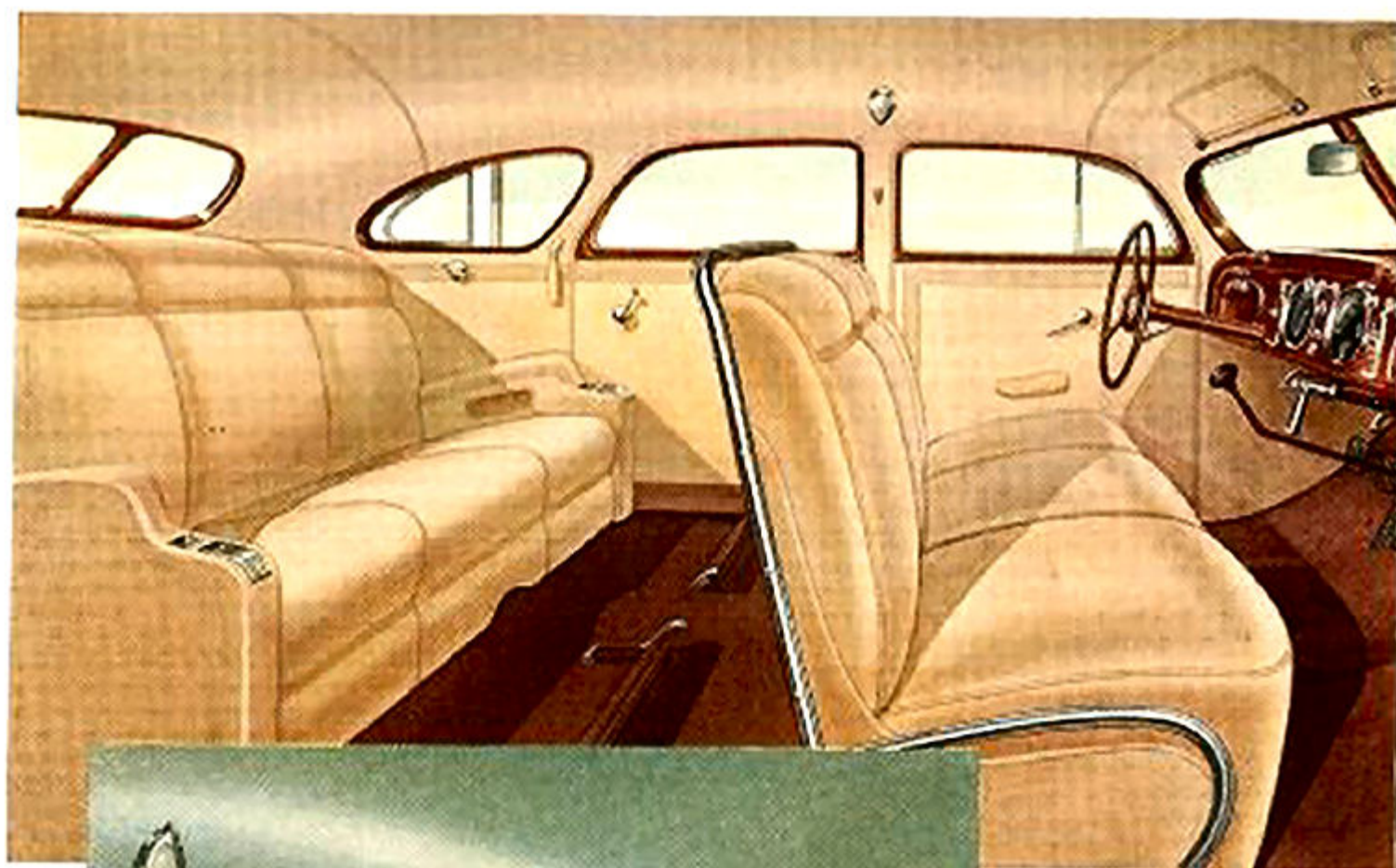

*The interior luggage compartment will be found of great convenience, when touring or commuting between town and country estates.*



# AT 45 MILES PER HOUR *a Miracle Happens*

Imagine yourself at the wheel of an Airflow Chrysler Imperial floating over the highway at 20—30—40. As the speedometer climbs to 45 there is a noticeable difference in motor performance—the hum of the motor fades—an invisible power seems to pull you along—that's the effect of the \*Automatic Overdrive going into operation.

The tremendous advantage of the overdrive in conserving engine life is readily apparent from the fact that it reduces engine speed thirty per cent at a given car speed. This means that at sixty-five miles an

hour the engine is running at a speed corresponding to forty-five miles an hour in conventional direct drive.

The reduction in engine speed brought about by the overdrive also means a tremendous gain in piston, piston ring, and cylinder bore life. In conventional drive each piston travels over four miles for each ten miles of car travel, or a total piston travel for an eight-cylinder engine of over thirty-two miles for each ten miles of car travel. It is also apparent that the overdrive also makes for increased economy of operation.

Tests conducted by Chrysler engineers have established a remarkable fuel economy factor for the overdrive. Using the Chrysler Imperial, a car of 323.5 cubic inches piston displacement, without overdrive, it was found possible to get 14.9 miles to the gallon at 20 miles an hour; 14.4 miles at 30 miles an hour; 13.7 miles at 40 miles an hour and 13.1 miles

at 50 miles an hour. Demands on horsepower are very large at speeds of upwards of 50 miles an hour and the curve drops sharply. Nevertheless at 60 miles an hour the Imperial got 11.8 miles per gallon.

With the Chrysler overdrive, the first test was conducted at 40 miles an hour. The remarkable figure of 16.9 miles per gallon was obtained at this speed, or two miles a gallon more than at 20 miles in conven-

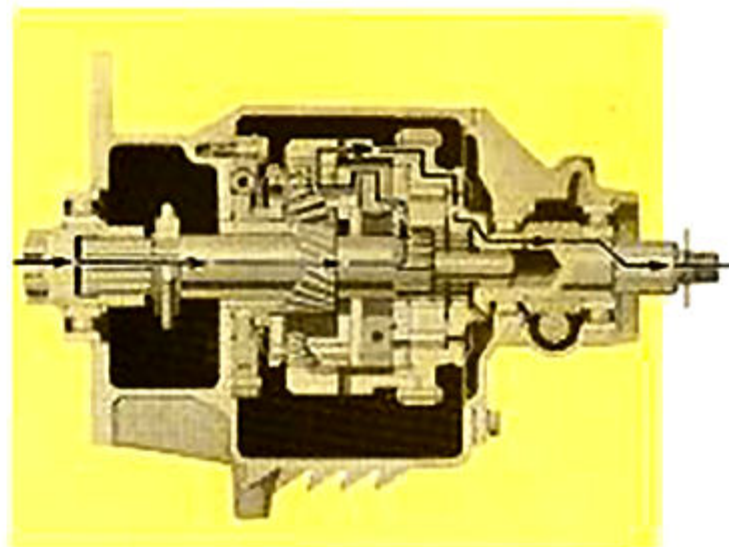

*Automatic Overdrive Unit*

tional drive. At 50 miles an hour the reading was 15.9 miles per gallon, still considerably higher than at 20 miles without the overdrive. At 60 miles an hour, a speed that "eats up" fuel in conventional drive, the Chrysler Imperial got 14.3 miles per gallon with the overdrive in operation, or within .6 miles per gallon of the figure for 20 miles an hour without overdrive.

*\*Automatic Overdrive is standard equipment on the Airflow Imperial and Custom Imperial and optional at a slight extra cost on the Airflow Eight.*

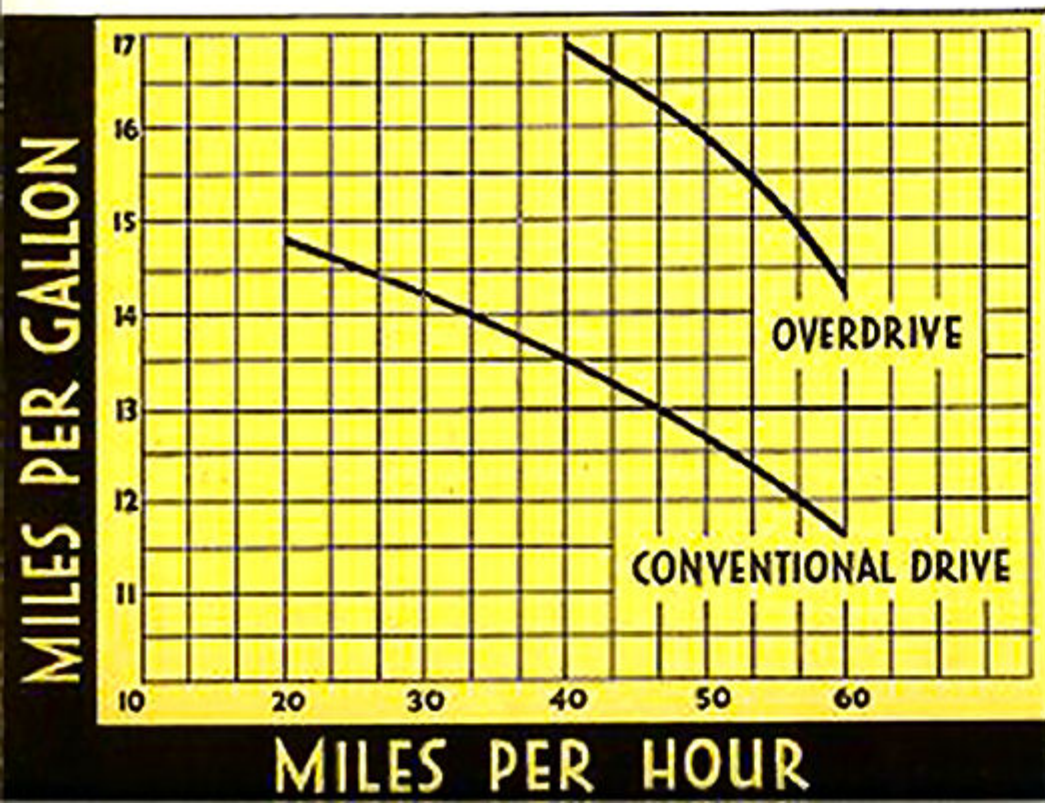



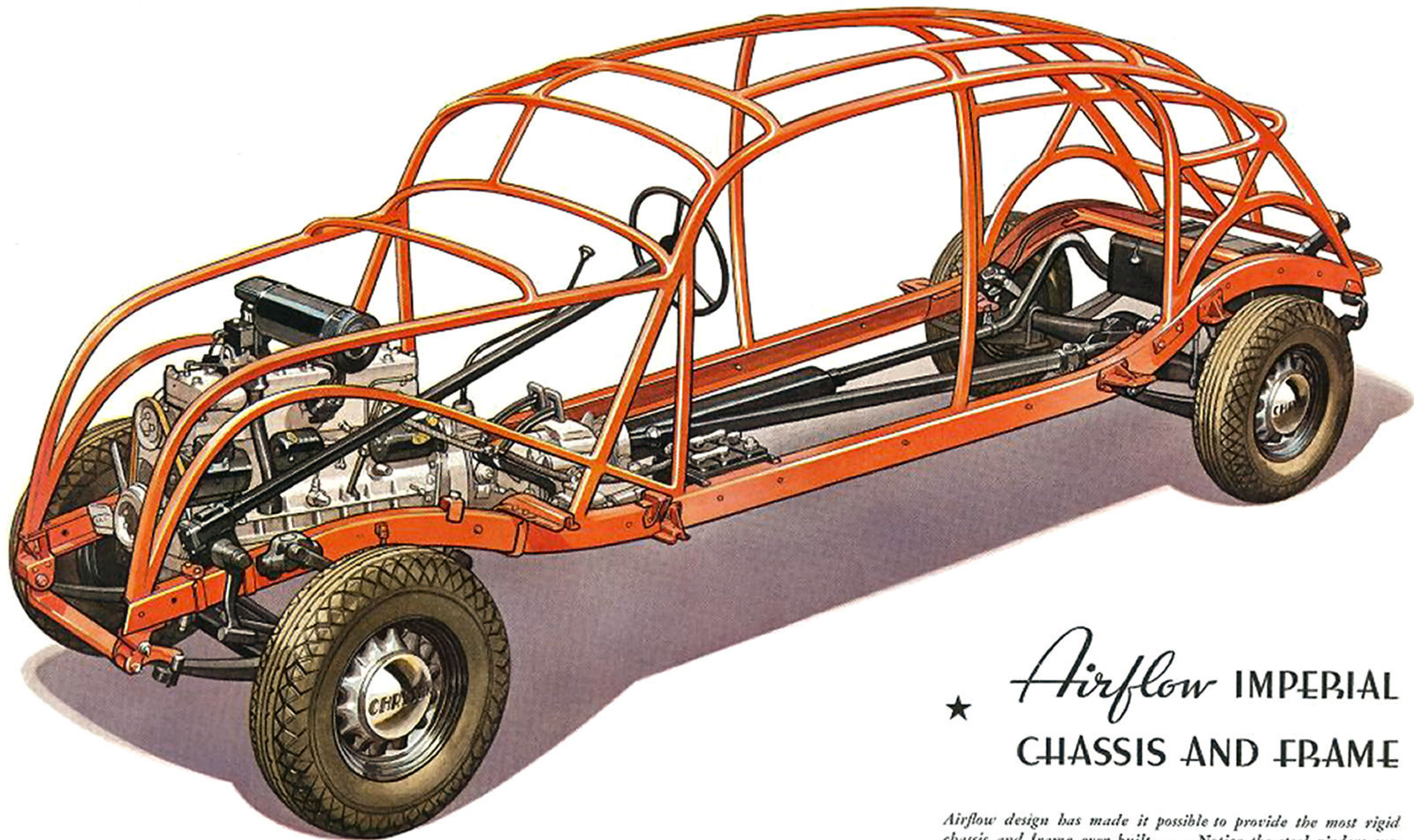

★ *Airflow* IMPERIAL  
CHASSIS AND FRAME

*Airflow design has made it possible to provide the most rigid chassis and frame ever built. . . . Notice the steel girders surrounding and protecting the occupants and absorbing shocks. In actual construction many of the body frame members shown above are integral with the body panels—the one reinforcing the other.*



# Engineered TO

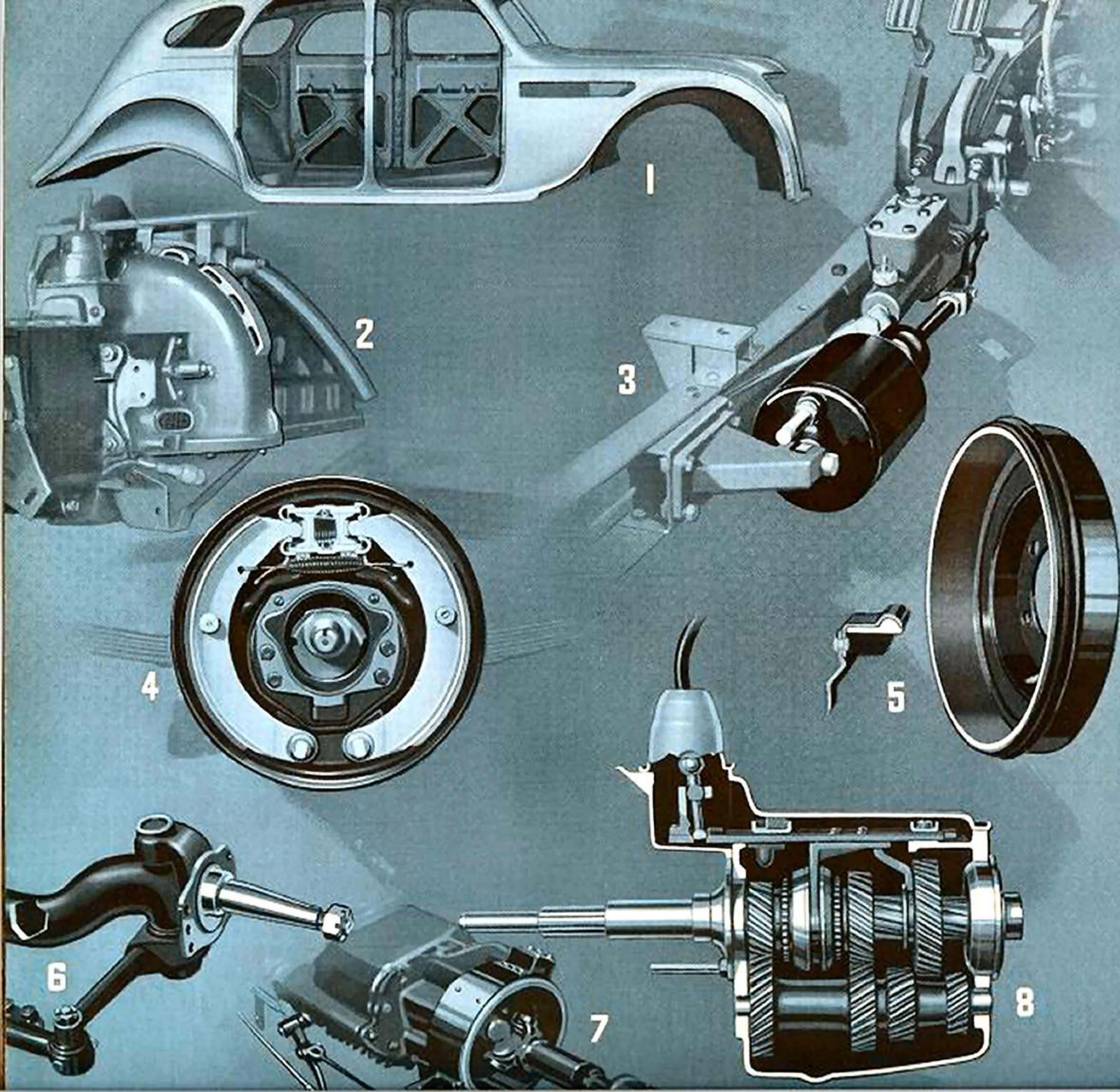

**1... UNIT BODY AND FRAME**—The body and frame of the Airflow Chrysler are one complete unit. Structural steel frame members extending from the extreme front of the hood to the other extreme in the rear are welded to sheets of heavy gauge steel forming the most rigid and safest body built.

**2... AIR-COOLED CLUTCH**—The clutch housing has a number of openings, the largest or inlet, screened to permit air to circulate and carry off heat from the clutch. This also breaks any vacuum between engine or transmission and prevents leakage of oil into the clutch chamber. Longer clutch life and smoother clutch engagement results.

**3... BRAKE BOOSTER**—In the Airflow Imperial models a power brake utilizes vacuum from the engine to exert the power necessary to actuate the brakes. As a result the driver is relieved of much braking effort, only sufficient pressure being needed to open the power brake valve.

**4... HYDRAULIC BRAKES**—The safest, easiest brakes to operate—they provide a positive equalized braking effect on all four wheels, that stops the car in a straight line without swerving. They are self-lubricating and weather-proof.

**5... CENTRIFUSE BRAKE DRUMS**—Centrifuse Brake Drums combine the lightness and strength of steel with the rapid heat-dissipating qualities of cast iron. This assures a non-scoring surface which prolongs lining life.

**6... TUBULAR FRONT AXLE**—Airflow Chryslers are equipped with a new Reverse Elliott Seamless tubular front axle which combines both strength and light weight. It is designed to safely withstand the most severe road shocks and maintain perfect alignment.

**7... HAND BRAKE**—The Hand Brake on the Airflow Chryslers operates independently of the Service Brakes on the propeller shaft. The brake drum is special cast iron and is equalized by the differential.



## STAY YEARS AHEAD

**8... SYNCRO-SILENT TRANSMISSION**—Makes possible quick, easy, silent shift through all gears at all speeds. All gears are helical cut, insuring long life and permanent quietness.

**9... STEERING**—The Airflow steering shaft is mounted forward of the front axle and the movement of the axle and springs has no effect on the steering geometry. Finger tip control and fatigueless driving result.

**10... SHOCK ABSORBERS**—Hydraulic double acting—both front and rear aid in maintaining maximum riding comfort in the new Airflow Chryslers.

**11... NEW TAPERED MULTI-LEAVED SPRINGS**—Use of a special alloy steel has made it possible to taper spring ends to a thinness never before attained. This produces a soft, fatigueless ride with freedom from squeaks.

**12... "U" BOLT SHACKLES**—Silent "U" spring shackles provide perfect freedom of movement but because of the pitch of the threads, side play and rattles are eliminated. They are permanently adjusted and noiseless at all times.

**13... ROAD SHOCK ELIMINATOR**—Prevents road shock from reaching the driver through the steering wheel. It is a specially designed shackle on the left front spring and contributes to driving comfort.

**14... UNIVERSAL JOINTS**—Of the roller-bearing type, packed in lubricant and sealed with metal covers, reduce friction to a minimum and make possible long periods of service without attention to lubrication.

**15... STABILIZER**—Located between the front wheels, this new device counteracts sway, caused in rounding curves. It keeps the body of the car on an "even keel", adding materially to riding comfort and safety.

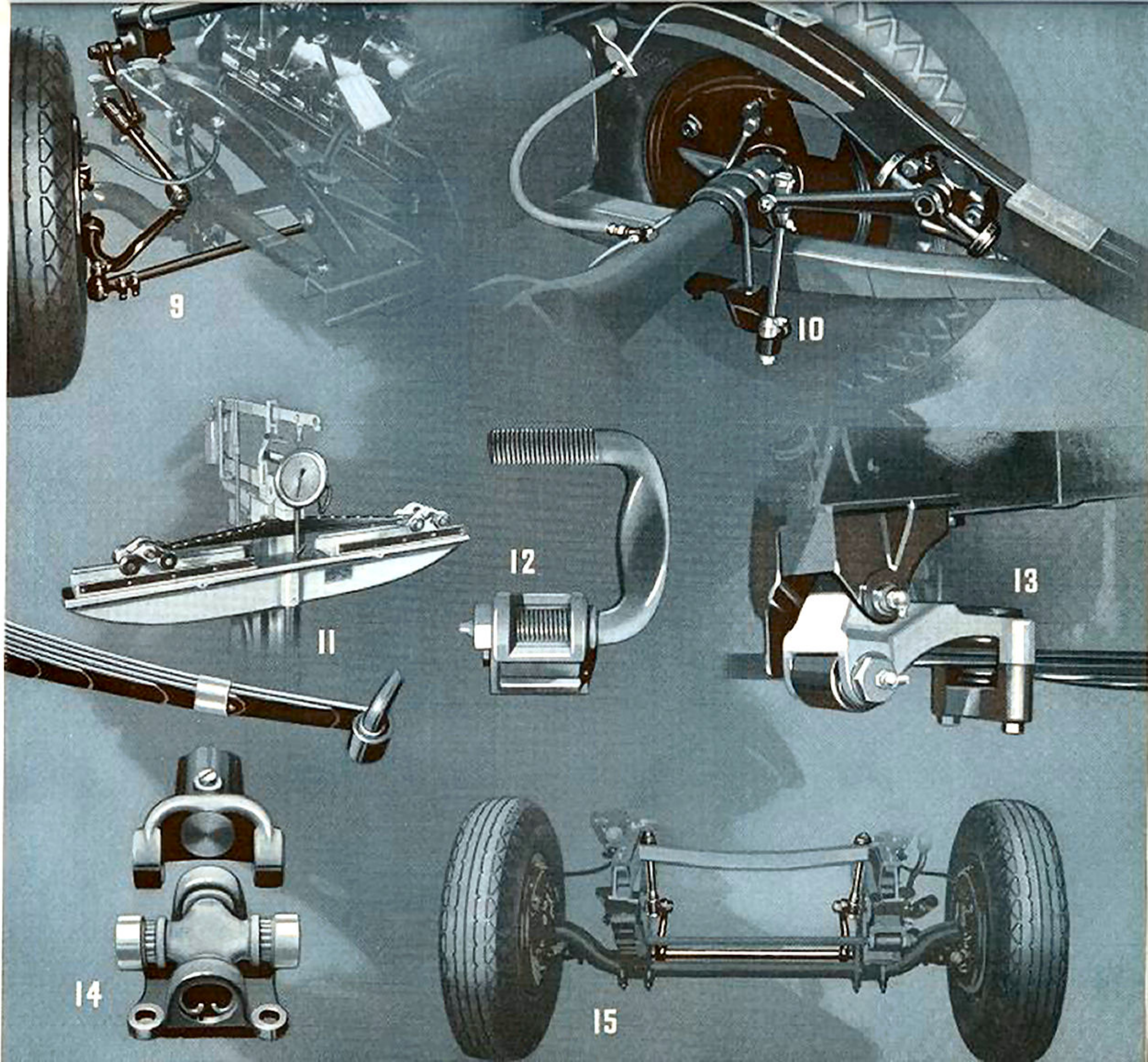



**16.. OIL FILTER**—Provides clean oil by constantly filtering all oil in circulation and results in more efficient engine performance and longer life both in the oil and moving parts.

**17.. AUTOMATIC CHOKE**—Regulates the amount of gas and air mixture to insure quick starting of the engine for all temperatures below 70 degrees. This means economy and efficiency and lessens dilution of oil.

**18.. MANIFOLD HEAT CONTROL**—A thermostatically controlled valve diverts the hot exhaust gases around the Intake Manifold when starting, providing maximum carburetion until running engine temperature is attained. The thermostat then opens the valve and exhaust gases pass directly out through the exhaust pipe.

**19.. VALVE SEAT INSERT**—All exhaust valve seats have inserts of tungsten steel alloy instead of the cast iron of the cylinder block. They are extremely hard and resist the terrific heat of the exhaust gases and seldom need attention under 30,000 miles.

**20.. FUEL PUMP**—Positive, uniform fuel is supplied at all speed ranges, angle or altitude with this diaphragm type pump with its air dome for even pressure.

**21.. AIR CLEANER AND INTAKE SILENCER**—Remove the road dust and all other abrasive material from air drawn into the carburetor preventing wear on pistons, rings and cylinders.

**22.. DISTRIBUTOR**—Completely waterproofed, with full automatic spark advance, the new Distributor contains an eight lobe cam with single breaker arm and protected condenser.

**23.. ANODIC TREATED T-SLOT PISTONS**—Through the special anodizing process Chrysler aluminum alloy pistons are given a hard wearing surface, increasing piston life and preventing scuffing or scoring in cold weather starting. Four rings provide an effective compression and oil seal.

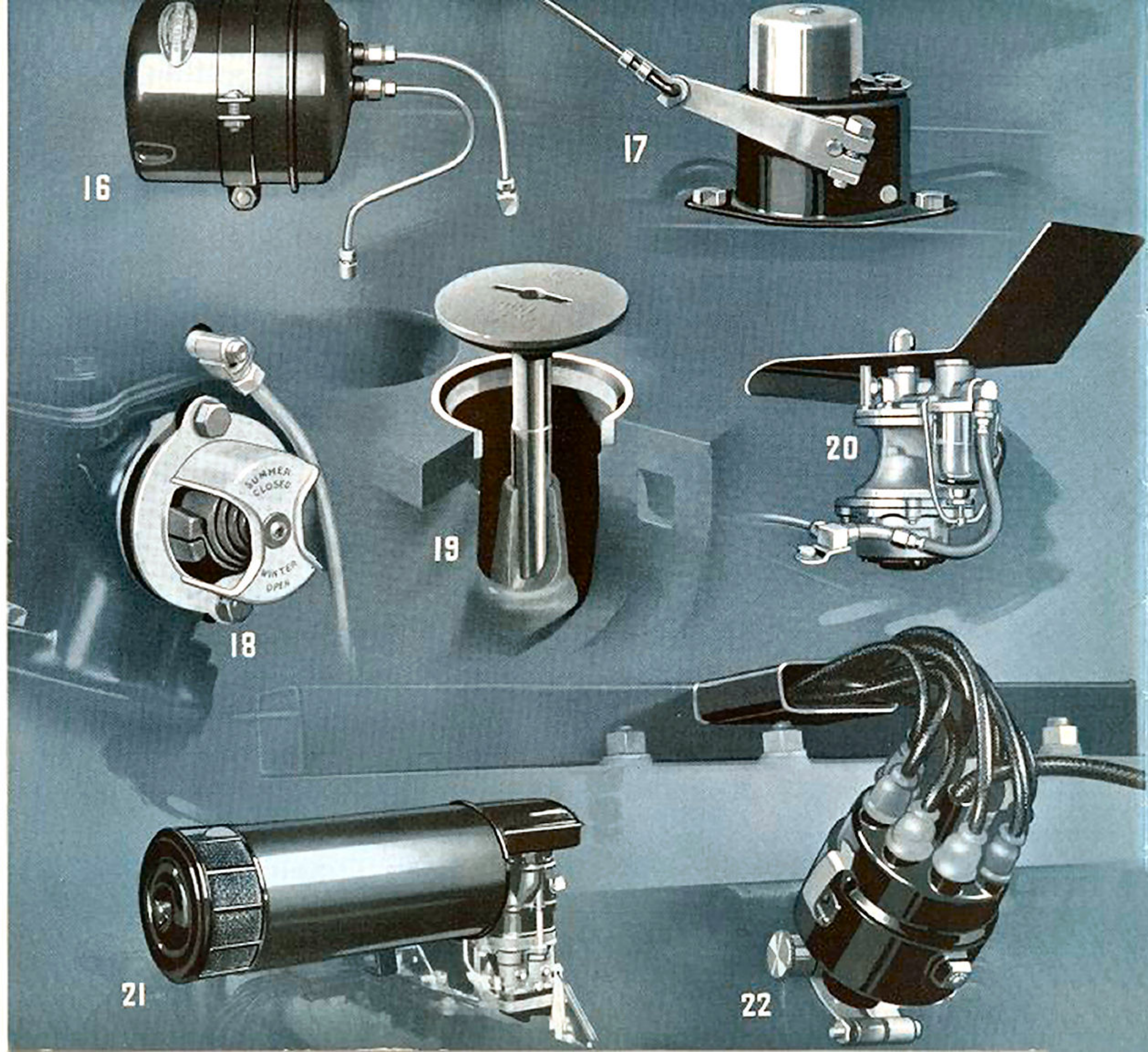





23

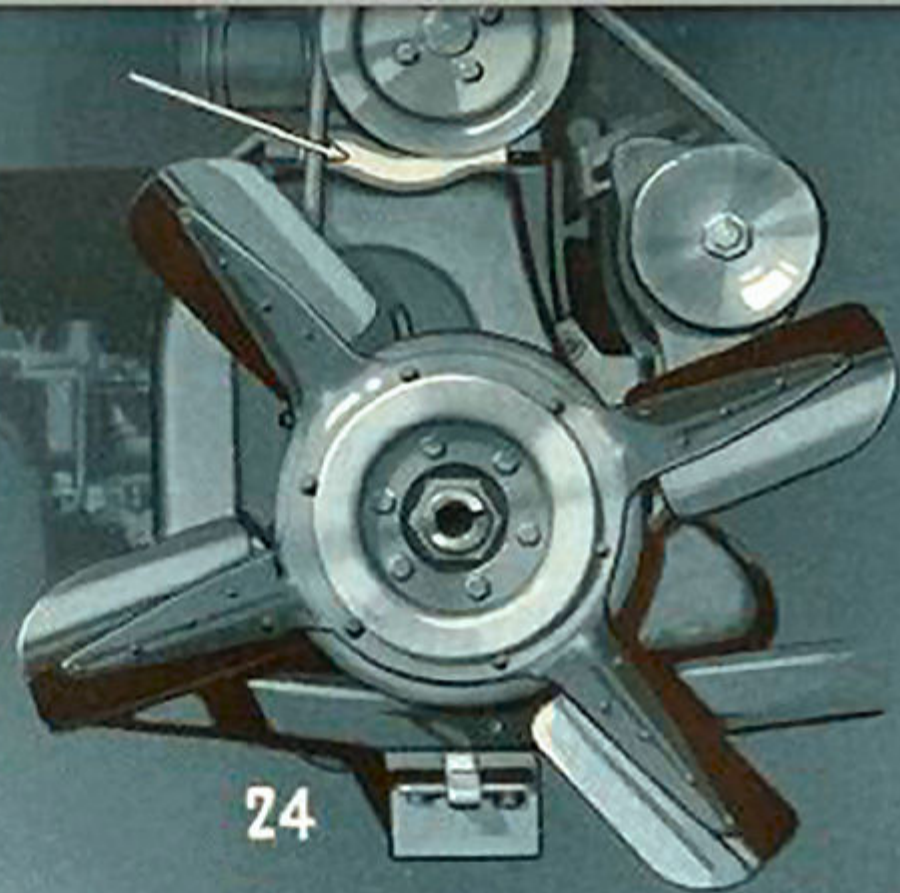

24

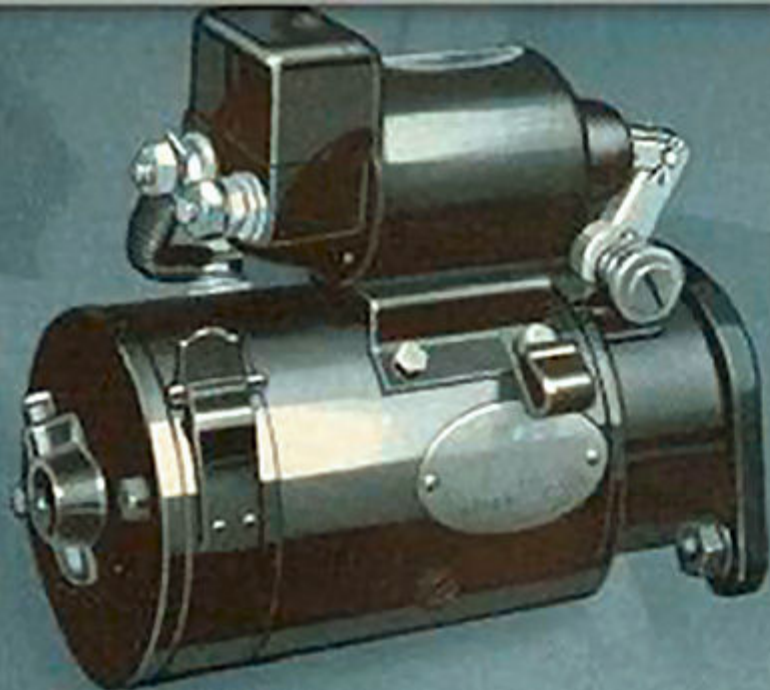

25

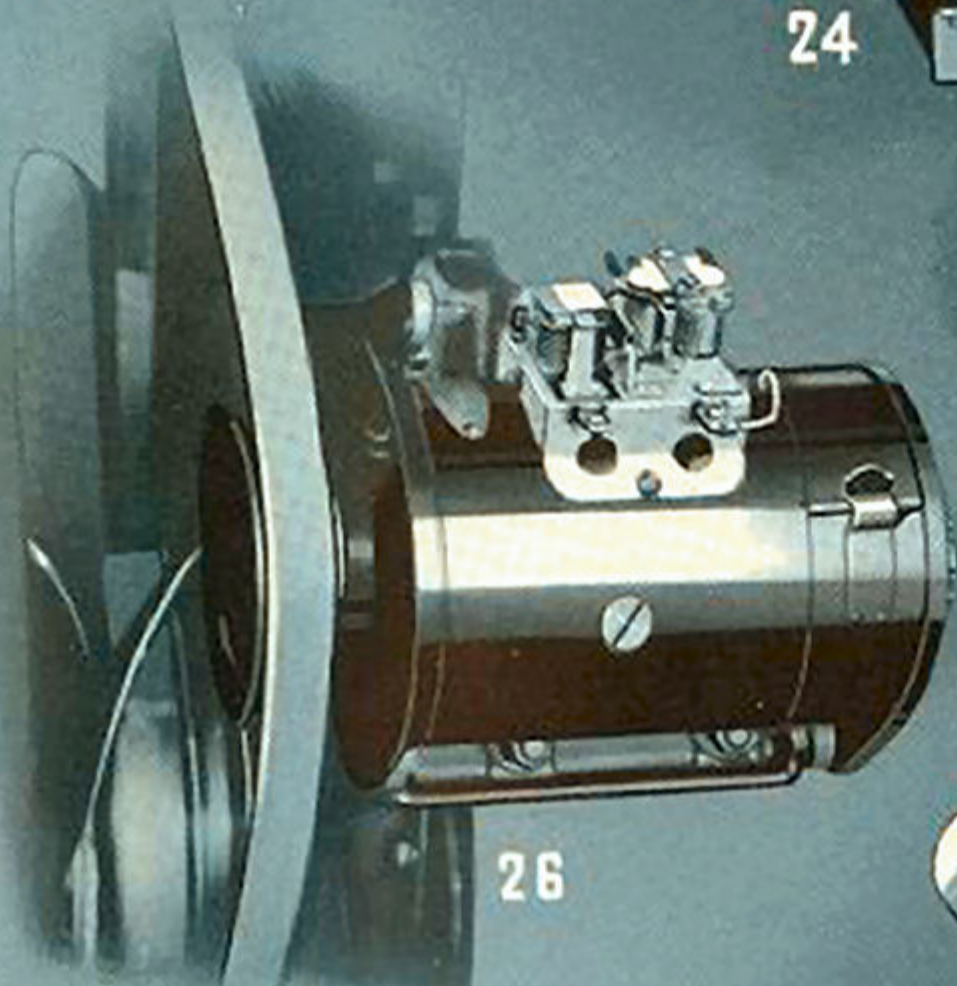

26

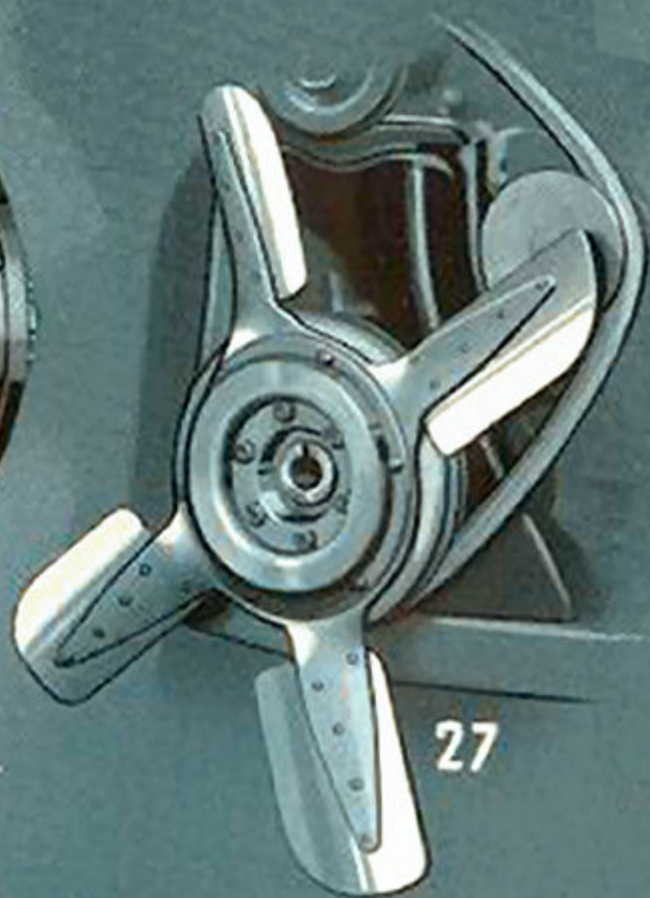

27



28



29



30

**24..FLOATING POWER MOUNTINGS**—In the new Airflow Chrysler the engine and transmission as a unit are cradled in rubber so that the entire power plant is suspended in perfect balance and in such a manner that all power tremor is absorbed by the rubber, providing unmatched smoothness. Floating Power Mountings consist of thick blocks of rubber insepably molded to steel.

**25..SOLENOID STARTER**—To start the engine simply depress the starter button on the instrument panel and the engagement of the starter gear is automatic with the correct throttle opening for easy starting. The design safeguards against engagement of the starter while the engine is running.

**26..GENERATOR**—Balanced, and regulated by voltage limit control relay and third brush regulation, a uniform six volt current is supplied for charging the battery to meet every demand and condition.

**27..IMPULSE NEUTRALIZER**—To produce still greater smoothness the Chrysler engine is equipped with an Impulse Neutralizer which cushions and absorbs the torque reaction on the crankshaft from the power strokes of the pistons.

**28..THERMOSTAT BY-PASS VALVE**—Reduces time of warming up period when engine is started by permitting water to circulate only within the water jacket of the cylinder block. Temperature thereafter is maintained uniformly within 5 degrees as the thermostat controls the circulation through the radiator, resulting in uniformly maximum engine efficiency.

**29..THE NEW CHRYSLER CRANKSHAFT**—has eight integrally forged counterweights. Accurately balanced both statically and dynamically, it provides exceptional smoothness and long life.

**30..CRANKSHAFT PRECISION BEARINGS**—Five, latest type, steel-backed babbitt alloy lined bearings with more than 62 square inches total bearing area, provide for the heavy counterweighted crankshaft a dependable, durable support in which to turn at any speed. Full pressure lubrication to all bearings insures miles of dependable service.



123-inch wheelbase

## AIRFLOW CHRYSLER

Eight



**AXLE (Front)**—Reverse Elliott seamless tubular—Ball thrust bearing at base of steering knuckle head—Spring cushioned ball and socket drag link joints—Road clearance 8 $\frac{3}{8}$ ".

**AXLE (Rear)**—Semi-floating pressed steel housing—Drive gears chrome nickel steel spiral bevel type—axle shaft chrome molybdenum steel—Road clearance 9 $\frac{1}{4}$ ".

**BODY (All Steel)**—Body frame and sill are welded into one unit—fused girder bridge type construction—body panels and cross members are electrically welded—trussed and braced with steel at all points of stress.

**BRAKE (Parking)**—External contracting on cast iron drum located on drive shaft at rear of transmission, hand controlled, individually operated.

**BRAKES (Service)**—Chrysler internal expanding hydraulic, all four wheels—Centrifuge brake drums, cast iron lined, drum diameter 13"—Woven and compressed asbestos lining 2" wide—Total contact area per car 198.8 sq. in.

**CARBURETION**—Downdraft, air cleaner integral with intake silencer—Automatic choke and manifold heat control.

**CLUTCH**—Single dry-plate type fully ventilated—Driven disc with asbestos facing—Torque cushioned by special coil springs.

**COOLING SYSTEM**—Water circulated by centrifugal pump—Cylinders and valves completely surrounded by large water passages—Water flow controlled by thermostat by-pass—Fin and tube radiator—Water capacity 4 $\frac{3}{4}$  gallons (3.95 Imperial gallons)—Silent four blade fan with impulse neutralizer mounted at end of crankshaft—Fan blades 20"—stagger-spaced to eliminate noises—"V" type belt with adjustment provided.

**CRANKSHAFT**—Statically and dynamically balanced—Eight counterweights forged integral with crankshaft—Supported on 5 steel backed bearings—Bearing diameter 2 $\frac{1}{4}$ "—Total bearing area 62.1 sq. in.

**ENGINE**—L-head type, water cooled, eight cylinders, four cycle—Bore 3 $\frac{1}{4}$ ", Stroke 4 $\frac{3}{8}$ "—N.A.C.C. horsepower 33.80—Developed horsepower at 3400 r.p.m. 115—Piston displacement 323.5 cu. in.—Motor mounting patented Floating Power—Engine and transmission cradled in rubber as unit—Torque reaction taken by two rubber cushioned mountings on either side of rear Floating Power motor rest mounting—Cylinder firing order 1-6-2-5-8-3-7-4—Camshaft drop forged with cams and distributor drive gear integral, six bearings—Exhaust valve seat inserts of tungsten high speed tool steel—Full pressure lubrication to all crankshaft, camshaft and connecting rod bearings, also throw from crankshaft and camshaft—Timing chain lubricated by direct oil leads—Oil pump driven by timing shaft from spiral gear on camshaft—Oil filtered, cleansed and cooled by passage through oil filter—Oil capacity 6 quarts—Pressure gauge on dash—level indicator on left side of crankcase—Crankcase ventilator.

**ELECTRICAL SYSTEM**—"Balanced Armature" generator, third brush and voltage limit control—full positive ventilation, high output radio type—six-volt. Starter, six-volt—Battery, six-volt, 136 ampere-hour capacity—Ignition, top outlet, eight lobe cam, waterproof distributor, single breaker arm type, full automatic advance, speed and vacuum control—Solar spark ignition.

**FENDERS**—Heavy one piece sheet steel—rustproofed before finishing.

**FUEL SYSTEM**—Downdraft carburetor, plain tube type, with idle speed adjustment and fixed jets—adjustable accelerating pump, automatic choke and idle control, Positive fuel pump, intake silencer, air cleaner and automatic manifold heat control—Fuel feed pump driven from camshaft—Fuel tank 21 gallons (17.5 Imperial gallons.)

**PISTONS**—Special anodic treated light aluminum alloy—T-slot type—two compression and two oil rings per piston.

**PISTON PIN**—Floating type—chrome nickel steel—bearing in piston and rod.

**PROPELLER SHAFT**—Tubular, roller bearing type universal joints.

**SPRINGS**—Semi-elliptic new tapered leaf—front length 44", width 2", fourteen leaves—rear length, 56 $\frac{1}{8}$ ", width 2", eleven leaves—silent U-Shackles, threaded—Rubber bushings on front end of rear springs.

**STEERING GEAR**—Mounted forward of left front axle—Worm and roller type, ratio 20.25 to 1, adjustable for wear—Steering arm drop forging heat treated—adjustable steering column—Road shock eliminator at front end of left front spring.

**TIRES**—Air wheel, 6-ply, non-skid tread all wheels—size 7.00 x 16".

**TRANSMISSION**—Synchro-silent, helical type gears throughout, first speed and reverse operating on spirally cut spline—second speed operates on constant mesh helically cut gear.

**WHEELBASE**—123"—Overall length bumper to bumper 206 $\frac{1}{4}$ "—Tread 57".

**STANDARD EQUIPMENT**—All body styles—double acting hydraulic shock absorbers—adjustable front seat—Flex-beam headlights in combination with parking lights—two automatic windshield wipers—non-glare rear view mirror—Two combination stop and tail lights—Dual trumpet horns mounted under hood—Dome light operated by switches—Two inside adjustable sun visors—Duplate Safety Glass in all windshields—Wheel equipment, five steel spoke with spare mounted at rear.

**SPECIAL EQUIPMENT**—Overdrive—bumpers front and rear—Special colors and upholsteries, also special equipment items and accessories available at nominal extra charge or on special order basis.

**SPECIAL NOTICE**—The manufacturer reserves the right to revise, change or modify the construction of Chrysler motor vehicles or any part thereof as he may see fit without incurring any obligation to install same on motor vehicles previously purchased.

128-inch wheelbase

## AIRFLOW CHRYSLER

**AXLE (Front)**—Reverse Elliott seamless tubular—Ball thrust bearing at base steering knuckle head—spring cushioned ball and socket drag link joints. Road clearance 9".

**AXLE (Rear)**—Semi-floating pressed steel housing—Drive gears chrome nickel steel spiral bevel type—axle shaft chrome molybdenum steel. Road clearance 9 $\frac{3}{4}$ ".

**BODY (All Steel)**—Body frame and sill are welded into one unit—fused girder bridge type construction—body panels and cross members are electrically welded—trussed and braced with steel at all points of stress.

**BRAKE (Parking)**—External contracting on cast iron drum located on drive shaft at rear of transmission, hand controlled, individually operated.

**BRAKES (Service)**—Chrysler internal expanding hydraulic, equipped with vacuum power booster, all four wheels—Centrifuge brake drums cast iron lined—drum diameter 13"—Woven and compressed asbestos lining 2" wide—Total contact area for car 198.8 sq. in.

**CARBURETOR**—Dual downdraft—Air cleaner integral with intake silencer—Automatic choke and manifold heat control.

**CLUTCH**—Single dry-plate—fully ventilated. Driven disc with woven asbestos facing. Torque cushioned by special coil springs.

**COOLING SYSTEM**—Water circulated by centrifugal pump. Cylinders and valves completely surrounded by large water passages—Water flow controlled by thermostat by-pass—Fin and tube radiator—Water capacity 4 $\frac{3}{4}$  gallons (4.05 Imperial gallons). Silent four-blade fan with impulse neutralizer mounted at end of crankshaft—Fan blades 20"—stagger-spaced to eliminate noise—"V" type belt with adjustment provided.

**CRANKSHAFT**—Statically and dynamically balanced—Eight counterweights forged integral with crankshaft—Supported on 5 steel backed bearings—Bearing diameter 2 $\frac{1}{4}$ "—Total bearing area 62.1 sq. in.

**ENGINE**—L-head type, water cooled, eight cylinders, four cycle—Bore, 3 $\frac{1}{4}$ ", stroke 4 $\frac{3}{8}$ "—N.A.C.C. horsepower 33.80—Developed horsepower at 3400 r.p.m. 130. Piston displacement 323.5 cu. in.—Aluminum cylinder head—Motor mounting patented Floating Power—Engine and transmission cradled in rubber as unit—Torque reaction taken by two rubber cushioned mountings on either side of rear Floating Power motor rest mounting—Firing order 1-6-2-5-8-3-7-4. Camshaft drop forged with cams and distributor drive integral—six bearings—Exhaust valve seat inserts of tungsten high speed tool steel—Full pressure lubrication to all crankshaft, camshaft and connecting rod bearings, also throw from crankshaft and camshaft—Timing chain lubricated by direct oil leads—Oil pump driven by timing shaft from spiral gear on camshaft—Oil filtered, cleansed and cooled by passage through oil filter—Oil capacity 6 quarts—Pressure gauge on dash—Level indicator on left side of crankcase—Crankcase ventilator.

**ELECTRICAL SYSTEM**—"Balanced Armature" Generator, third brush and voltage limit control, six volt type—Starter, six volt—Battery, 6 volt, 136 ampere hour capacity—Ignition, top outlet, eight lobe cam, waterproof distributor, single breaker-arm type, full automatic advance—Solar spark ignition.



# C A T I O N S

## Imperial



**FENDERS**—Heavy one-piece sheet steel—rustproofed before finishing.  
**FREE WHEELING**—Two bearing, selective cam and roller type located at rear of transmission—Lockout button on instrument panel—Operates in all forward speeds, automatic lockout in reverse.

**FUEL SYSTEM**—Dual down-draft carburetor with idle speed adjustment and fixed jets—Positive fuel pump driven from camshaft, adjustable accelerating pump, automatic choke and idle control, intake silencer, air cleaner, automatic manifold heat control—Fuel tank 21 gallons (17.5 Imperial gallons).

**OVER-DRIVE**—All helical planetary gears—silent operation—provides slower engine speed at higher car speeds resulting in longer life, greater economy and smoother performance operation—automatic through accelerator pedal.

**PISTONS**—Special anodic treated light aluminum alloy—T-slot type two compression and two oil rings per piston.

**PISTON PIN**—Floating type—chrome nickel steel-bearing in piston and rod.

**PROPELLER SHAFT**—Tubular, roller bearing type universal joints.

**SPRINGS**—New tapered leaf type—Semi-elliptic, front, length 44", width 2 3/4", thirteen leaves—rear, length 56 5/8", width 2", twelve leaves, silent U-threaded shackles—Rubber bushing in front end of rear springs.

**STEERING GEAR**—Mounted forward of left front axle—worm and roller type, ratio 20.5 to 1, adjustable for wear—Steering arm drop forging heat treated—Adjustable steering column—Road shock eliminator at front end of left forward spring.

**TIRES**—Air wheel—6-ply—non-skid tread on all wheels—size 7.50 x 16".

**TRANSMISSION**—Synchro-silent transmission, helical type gears throughout, first speed and reverse operating on spirally cut spline, second speed operates on constant mesh helically cut gear—Overdrive unit at rear.

**WHEELBASE**—128", Overall length with bumpers 211 1/2"—Tread 57".

**STANDARD EQUIPMENT**—All body types, double acting hydraulic shock absorbers—adjustable front seat—Flex-beam headlamps, parking lights in combination with headlamp—Two automatic windshield wipers—non-glare rear view mirror—Two combination stop and tail lights—Dual trumpet horns mounted under hood—Two dome lights operated by door switches—Two inside adjustable sun visors on all models. Duplate Safety Glass in all windshields and pivoting ventilating wings. Wheel equipment—5 steel spoke wheels with spare mounted in the rear.

**SPECIAL EQUIPMENT**—Bumpers front and rear—Special colors and upholstery—also many special equipment items and accessories are available at nominal extra charges on special order basis.

**SPECIAL NOTICE**—The manufacturer reserves the right to revise, change or modify the construction of Chrysler motor vehicles or any part thereof as he may see fit without incurring any obligation to install same on motor vehicles previously purchased.

137-inch wheelbase

## AIRFLOW CHRYSLER Custom IMPERIAL



**AXLE (Front)**—Reverse Elliott seamless tubular—Ball thrust bearing at base steering knuckle head—spring cushioned ball and socket drag link joints. Road clearance 9".

**AXLE (Rear)**—Semi-floating pressed steel housing—Drive gears chrome nickel steel spiral bevel type—axle shaft chrome molybdenum steel. Road clearance 9 3/8".

**BODY (All Steel)**—Body frame and sill are welded into one unit—fused girder bridge type construction—body panels and cross members are electrically welded—trussed and braced with steel at all points of stress.

**BRAKE (Parking)**—External contracting on cast iron drum located on drive shaft at rear of transmission, hand controlled, individually operated.

**BRAKES (Service)**—Chrysler internal expanding hydraulic, equipped with vacuum power booster, all four wheels—Centrifuge brake drums cast iron lined—drum diameter 13"—Woven and compressed asbestos lining 2" wide—Total contact area for car 198.8 sq. in.

**CARBURETOR**—Dual downdraft—Air cleaner integral with intake silencer—Automatic choke and manifold heat control.

**CLUTCH**—Single dry-plate—fully ventilated. Driven disc with woven asbestos facing. Torque cushioned by special coil springs.

**COOLING SYSTEM**—Water circulated by centrifugal pump. Cylinders and valves completely surrounded by large water passages—Water flow controlled by thermostat by-pass—Fin and tube radiator—Water capacity 4 7/8 gallons (4.05 Imperial gallons). Silent four-blade fan with impulse neutralizer mounted on end of crankshaft—Fan blades 20"—stagger-spaced to eliminate noise—"V" type belt with adjustment provided.

**CRANKSHAFT**—Statically and dynamically balanced—Eight counterweights forged integral with crankshaft—Supported on 5 steel backed bearings—Bearing diameter 2 1/4"—Total bearing area 62.1 sq. in.

**ENGINE**—L-head type, water cooled, eight cylinders, four cycle—Bore 3 1/4", stroke 4 7/8"—N.A.C.C. horsepower 33.80—Developed horsepower at 3400 r.p.m. 130. Piston displacement 323.5 cu. in.—Aluminum cylinder head—Motor mounting patented Floating Power—Engine and transmission cradled in rubber as unit—Torque reaction taken by two rubber cushioned mountings on either side of rear Floating Power motor rest mounting—Firing order 1-6-2-5-8-3-7-4. Camshaft drop forged with cams and distributor drive integral—six bearings—Exhaust valve seat inserts of tungsten high speed tool steel—Full pressure lubrication to all crankshaft, camshaft and connecting rod bearings, also throw from crankshaft and camshaft—Timing chain lubricated by direct oil leads—Oil pump driven by timing shaft and spiral gear on camshaft—Oil filtered, cleansed and cooled by passage through oil filter—Oil capacity 6 quarts—Pressure gauge on dash—Level indicator on left side of crankcase—Crankcase ventilator.

**ELECTRICAL SYSTEM**—"Balanced Armature" Generator, third brush and voltage limit control, six volt type—Starter, six volt—Battery, 6 volt, 136 ampere hour capacity—Ignition, top outlet, eight lobe cam,

waterproof distributor, single breaker-arm type, full automatic advance—Solar spark ignition.

**FENDERS**—Heavy one-piece sheet steel—rustproofed before finishing.  
**FREE WHEELING**—Two bearing, selective cam and roller type located at rear of transmission—Lockout button on instrument panel—Operates in all forward speeds, automatic lockout in reverse.

**FUEL SYSTEM**—Dual down-draft carburetor with idle speed adjustment and fixed jets—Positive fuel pump driven from camshaft, adjustable accelerating pump, automatic choke and idle control, intake silencer, air cleaner, automatic manifold heat control—Fuel tank 21 gallons (17.5 Imperial gallons).

**OVER-DRIVE**—All helical planetary gears—silent operation—provides slower engine speed at higher car speeds resulting in longer life, greater economy and smoother performance operation—automatic through accelerator pedal.

**PISTONS**—Special anodic treated light aluminum alloy—T-slot type two compression and two oil rings per piston.

**PISTON PIN**—Floating type—chrome nickel steel-bearing in piston and rod.

**PROPELLER SHAFT**—Tubular, roller bearing type universal joints.

**SPRINGS**—New tapered leaf type—Semi-elliptic, front, length 44", width 2 3/4", fifteen leaves—rear, length 56 5/8", width 2", twelve leaves, silent U-threaded shackles—Rubber bushing in front end of rear springs.

**STEERING GEAR**—Mounted forward of left front axle—worm and roller type, ratio 20.5 to 1, adjustable for wear—Steering arm drop forging heat treated—Adjustable steering column—Road shock eliminator at front end of left forward spring.

**TIRES**—Air wheel—6-ply—non-skid tread on all wheels—size 7.50 x 16".

**TRANSMISSION**—Synchro-silent transmission, helical type gears throughout, first speed and reverse operating on spirally cut spline, second speed operates on constant mesh helically cut gear—Overdrive unit at rear.

**WHEELBASE**—137", Overall length with bumpers 220 1/4"—Tread 57".

**STANDARD EQUIPMENT**—All body styles, double acting hydraulic shock absorbers—adjustable front seat—Flex-beam headlamps, parking lights in combination with headlamp—Two automatic windshield wipers—non-glare rear view mirror—Two combination stop and tail lights—Dual trumpet horns mounted under hood—Two dome lights operated by door switches—Two inside adjustable sun visors on all models. Duplate Safety Glass in all windshields and pivoting ventilating wings. Wheel equipment—5 steel spoke wheels with spare mounted in the rear.

**SPECIAL EQUIPMENT**—Bumpers front and rear—Special colors and upholstery—also many special equipment items and accessories are available at nominal extra charges on special order basis.

**SPECIAL NOTICE**—The manufacturer reserves the right to revise, change or modify the construction of Chrysler motor vehicles or any part thereof as he may see fit without incurring any obligation to install same on motor vehicles previously purchased.



