



PLYMOUTH

neon

BREEZE

VOYAGER

POWER



VOYAGER EXPRESSO



GRAND VOYAGER EXPRESSO



PROWLER



NEON EXPRESSO SEDAN



NEON EXPRESSO COUPE



BREEZE EXPRESSO



What's your idea of ... Value? Dependable? Innovative? Fun? At Plymouth, we put all of those great attributes together to create some great cars and minivans. It's all part of **Plymouth's personality**. Vehicles that are fun to drive, versatile, loaded with intelligent (and very innovative) features, roomy and comfortable (thanks to cab-forward architecture) and designed with safety and reliability in mind. All of this makes owning and driving a Plymouth such a rewarding experience.

That's why so many Plymouth owners end up with a very overwhelming feeling: **a sense of pride**. (And a very good sense that they've made a very good choice.) Another reason's because you get all of this for a really smart price. After all, anyone could build a car that had every feature. But at Plymouth, we pick the **important features** (the parts most important to you) and arrange them in packages that fit you and your lifestyle. **You get the idea.**

Since the time of printing, some of the information you'll find in this catalog may have been updated. Ask your dealer for details. Some of the equipment shown or described throughout this catalog is available at extra cost.

Only Plymouth could produce a two-seat roadster with scoot that snaps off a sincere salute to hot rodding. Here is a test bed of new materials and technology. The body is concocted of a heady brew: 5046 and 6022 aluminum alloys, sheet molding compound, reaction-injected molded urethane, and a polymer in its sensually retro grille imposingly called "acrylonitrile butadiene styrene." Of its under-3,000-pound weight, nearly a third is aluminum, including the frame rails that are extruded from 6061 and 6063 all-aluminum alloys.

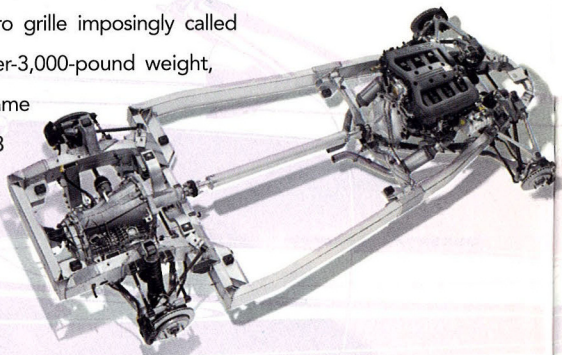

PROWLER PACKS TECHNOLOGY AND PERSONALITY
INTO A CAR THAT'S A BLAST TO DRIVE.



Prowler



Like any proper "highboy" roadster, Prowler's body sits atop a frame. Nestled up front is an ultra-contemporary, all-aluminum, 3.5-liter single overhead cam 24-valve V6 that cranks out 253 horsepower at 6,400 rpm. According to engineers, less mass up front should provide more balanced handling, as well as quicker acceleration through a better

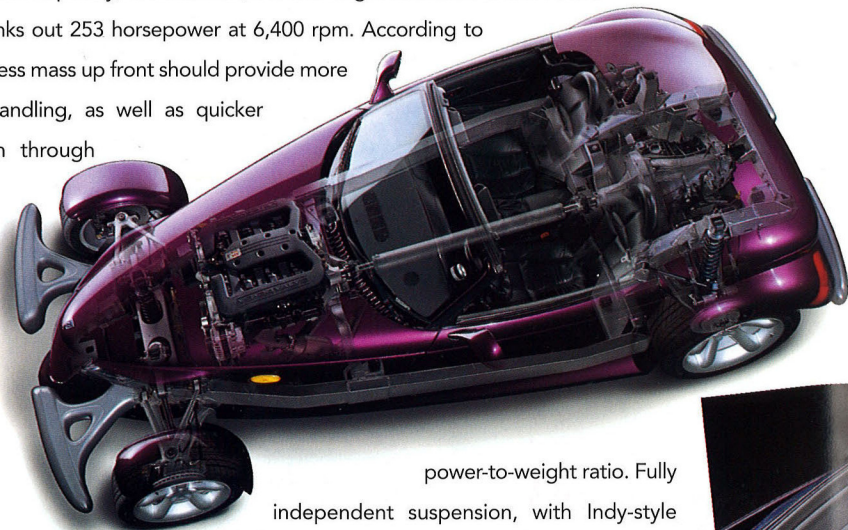

power-to-weight ratio. Fully independent suspension, with Indy-style hidden shocks up front, and a four-speed/overdrive automatic rear transaxle, like the new Ferrari 456GTA's. Four-wheel discs haul Prowler to a stop in well under 200 feet. Lateral acceleration measures .84g on a skidpad. All in all, surprisingly exotic all-around performance from a car whose roots extend back in time to straight-line runs on a dry California lake bed.

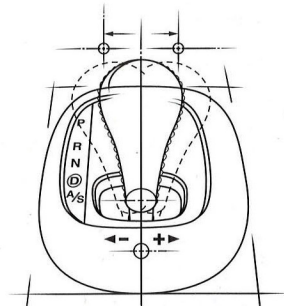

AUTOSTICK® FOUR-SPEED PROVIDES AUTOMATIC, OR DRIVER-DECIDED GEAR CHANGES FOR MORE CONTROL.



GAUGES ARE TRADITIONAL — BACKLIT, CIRCULAR, ANALOG, AND COMPLETE. TACH IS COLUMN-MOUNTED, WHERE IT OUGHT TO BE ON A RODNEY. THE SEVEN-SPEAKER AM/FM/CASSETTE/SIX-DISC CD SOUND SYSTEM BY INFINITY® PRODUCES A TOTAL OF 320 JAM-KICKIN' WATTS THROUGH A PARAMETRICALLY EQUALIZED 40-WATT-PER-EACH OF EIGHT CHANNELS AMPLIFIER, SO THAT TOP-DOWN, LEGAL-LIMIT CRUISIN' DOESN'T BLOW THE SOUNDS AWAY.



Instrument panel surround painted to match body color. Prowler Yellow available at extra cost later in model year.

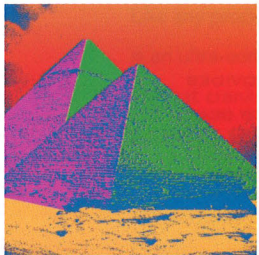

The first and only car in its class with space-making, handling-enhancing cab-forward architecture, Neon is available in two-door or four-door versions. Plymouth Neon is equipped with the best-in-class output and efficiency of a 132-hp* 2.0-liter 16-valve four-cylinder engine. For more potency, a 150-hp† dual overhead cam edition is included on Neon Expresso (below), which also sports: A power bulge hood. An aerodynamic rear spoiler. Sport bolt-on wheel covers. Sport fascias with integral round fog lamps up front. A color-infused Rumba Cloth interior trim (right). A performance five-speed manual. Air conditioning. A front passenger-assist handle. And full instrumentation — including an 8,000-rpm tachometer.

*The 2.0-liter engine is also available to meet California TLEV Emission Standards with 129 hp @ 6,000 rpm and 127 lb-ft torque @ 4,800 rpm. †Achieved with premium unleaded fuel. However, engine does not require premium unleaded fuel.



The Plymouth Neon Sedan is now available with a special Style Package (below right). It includes a power sunroof. Power windows, locks and exterior mirrors. Air conditioning. An AM/FM stereo radio with a cassette player, built-in CD changer controls and eight speakers. A wonderfully inviting Tango Cloth interior (right), accented with a leather-wrapped steering wheel and shift knob. Exclusive exterior colors. Bright wheel cover lug nuts. Body-color door handles. And a front passenger-assist handle.

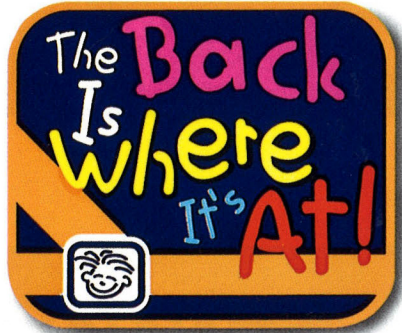

THE BACK IS WHERE IT'S AT! ALTHOUGH ALL TYPES OF AIR BAGS HAVE SAVED LIVES, PARENTS ARE REMINDED TO ALWAYS BUCKLE CHILDREN IN THE BACKSEAT. BE SURE TO NEVER PLACE REARWARD-FACING INFANT SEATS IN THE FRONT SEAT OF A VEHICLE WITH ANY KIND OF FRONT-PASSENGER AIR BAG. FOR MORE INFORMATION ABOUT THE "ABCs OF AIR BAG SAFETY," VISIT WWW.CHRYSLER.COM/ABC/INDEX.HTML ON THE INTERNET.



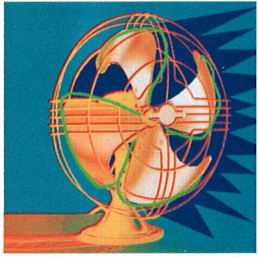

Like a breath of fresh air, the Plymouth Breeze is invigorating. This refreshing sporty four-door supplies the kind of interior space a growing young family needs. Plus a long list of innovations you'd expect from Plymouth — like a modified double-wishbone suspension for superior handling, seats designed to reduce driving fatigue and rail-through construction for quiet on-road driving stability. And new for 1998, there's the available sporty and value-packed Espresso Package (shown below). Features include Rhythm cloth interior, Nitro wheel covers, exterior accents, AM/FM stereo with cassette plus more.



Breeze



PLYMOUTH HAS CREATED A PERFECT HARMONY BETWEEN DRIVER AND INSTRUMENT PANEL. EVERY SWITCH AND GAUGE HAS BEEN STRATEGICALLY LOCATED FOR MAXIMUM CONTROL AND READABILITY WITH MINIMUM DISTRACTION. IT'S JUST WHAT YOU EXPECT FROM PLYMOUTH.

Breeze emerged from the imagination of designers and engineers as a dramatic, contemporary vision of what people really need in an automobile. Innovative engineering and cab-forward design assure a roomy and airy interior, excellent visibility, and a superbly stable ride. With standard features like a responsive 2.0-liter 16-valve engine, Next Generation driver and front-passenger air bags,* height-adjustable front shoulder belts, child-protection rear door locks, air conditioning, AM/FM stereo radio with six speakers and center armrest, the terms "nicely equipped" and "exceptional value" take on a new meaning. Speaking of meaningful innovation, Breeze's seats and backs eliminate "pressure points" that can cause squirming and fatigue. And the standard folding rear seatback makes for a great pass-through trunk, expanding Breeze's cargo-carrying capacity. There's an available 2.4-liter DOHC 16-valve engine for more power on demand.

*Certified to the new Federal Regulations that allow for less forceful air bags. Always use seat belts. Remember a back-seat is the safest place for children.





You expect a lot of forward thinking in every Plymouth Voyager and Voyager SE. That's why they're quieter. Sleeker. Brimming with convenience and safety features. And the ride and handling is even more car-like with an improved suspension system. Expect your expectations to be fulfilled. In addition to a reliable 2.4-liter DOHC SMPI engine, there's a three-speed automatic on Voyager or a 3.0-liter SMPI V6* engine with a four-speed automatic on Voyager SE, power steering, AM/FM stereo and deluxe intermittent wipers. Also check out Voyager's optional Family Value Package† (right) for a host of value-packed features such as air conditioning, 7-passenger seating and under-seat storage drawer. Want to add some extra zest? Try the available Espresso Package‡ (above). It's sharp looking and loaded with high-value equipment.

Voyager

*Built by Mitsubishi Motors Corporation. Not available in CA, CT, MA and NY.

†Available on all Voyager and Grand Voyager models. Package content may vary depending on model. See your dealer for details.

‡Espresso Package available on Voyager SE and Grand Voyager SE models. See dealer for package contents.



INTELLIGENT DETAILS ABOUND IN VOYAGER. CENTER CONSOLE CUP HOLDERS (LEFT) HOLD A VARIETY OF BEVERAGE CONTAINERS. LOCKABLE UNDERSEAT STORAGE DRAWER‡ (RIGHT) KEEPS VALUABLES OUT OF SIGHT.

‡Available on base Voyager and Grand Voyager; standard on other models.



This is the minivan that "grows" with your growing needs. Plymouth Grand Voyager and Grand Voyager SE. Inside and out, front to back and from side to side, America's original minivan delivers more room, more versatility, more comfort, more of everything. Plymouth has translated innovation into an array of innovative features. Start with a proven 3.0-liter SMPI V6* engine, seven-passenger seating, available antilock brakes, panoramic visibility, and available Dual Zone Temperature Control for individual front-passenger comfort. But don't stop there. Plymouth didn't. For 1998, you can showcase Grand Voyager SE's fun and sporty personality with Plymouth's available high-value Espresso Package! Special features include: distinctive 15-inch wheel covers, sunscreen and solar glass, AM/FM stereo with CD player and much more!



*Built by Mitsubishi Motors Corporation. Not available in CA, CT, MA or NY.

†Espresso Package available on Voyager SE and Grand Voyager SE models. See dealer for package content.

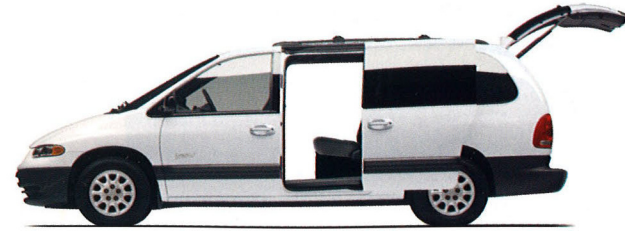

A GREAT IDEA FOR A GRAND OPENING! GRAND VOYAGER'S STANDARD DRIVER-SIDE SLIDING DOOR OPENS A WHOLE NEW WORLD OF CONVENIENCE AND ACCESSIBILITY.



GRAND
Voyager



Here are some very innovative seats that are the best things on wheels. Plymouth's revolutionary Easy Out Roller Seats.[®] Aircraft-style wheels on the middle and rear bench seats "click" down for moving or removing a seat; then they "click" back up to lock the seat firmly in place. Easy. Simple. A cinch to move. And engineered for optimum safety. The perfect complement to Grand Voyager's standard seven-passenger seating (shown below). It's comfortable, spacious, and a snap to rearrange for a custom interior. What could be more convenient? Or more Plymouth?



GRAND VOYAGER SE'S WRAPAROUND INSTRUMENT PANEL HAS THE INNOVATIVE TOUCH OF A LOWER STEERING COLUMN ANGLE FOR A MORE CAR-LIKE FEELING OF CONTROL AND RESPONSIVENESS.





SAFETY/MOPAR ACCESSORIES Plymouth is proud that its 1998 passenger cars meet all federal passenger car safety standards. And all Plymouth vehicles meet 1999 federal dynamic side-impact protection requirements.* Standard Next Generation driver and front-passenger air bags[†] (A), used in conjunction with Plymouth's Unibelt restraints, are one of the best safety systems available today. Available Integrated Child Seats[‡] (B) are the most convenient method for safely and comfortably transporting young passengers. There's only one choice for quality vehicle accessories — Authentic Mopar Accessories. EVS II[®] (C) is an optional, self-operating Mopar theft-deterrent system with a personal panic mode and much more. See your Plymouth dealer today for a complete Mopar Accessories listing. From touch-up paint to bike carriers, no one but Mopar offers you more choices of accessories for your Plymouth vehicle.

*Your salesperson has a complete listing of safety features for the Plymouth of your choice.
[†]Next Generation air bags are certified to the new Federal Regulations that allow less forceful air bags. Always use seat belts. Remember a backseat is the safest place for children. Next Generation front-passenger air bag only on Voyager and Grand Voyager.
[‡]See your salesperson for availability and child age/weight/height restrictions.

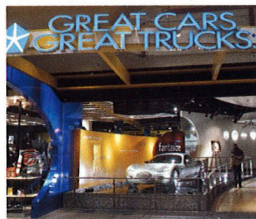

Great Cars. Great Trucks. Some pretty remarkable things have been happening at Chrysler Corporation the past few years. New products. Cab-forward design. Accolades. Awards. Plymouth's played a major role in this success with cars and minivans that are filled to the brim with meaningful innovation and continuous improvements. The next logical step was to create a totally innovative **shopping process** to make car buying as easy as pie. *Voila!* It's fun. It's fast. A pure-Plymouth shopping experience. Stop by on the Internet at www.plymouthcars.com (a great place to spec, equip and price the Plymouth you want). Or you can always reach us toll-free at 1-800-PLYMOUTH where a helpful advisor will answer your questions. Complete information. Total convenience. **That's Plymouth.**

THE OWNERSHIP PROMISE

A product can be no better than the willingness of its maker to stand behind it. That's why Chrysler Corporation, through its Customer One Care™ program, promises its owners a satisfying experience at the dealership and long after they drive their new cars from the showroom. Included in that promise: bumper-to-bumper protection for three years or 36,000 miles; 24-hour-a-day roadside assistance for the same period; a five-year or 100,000-mile assurance against sheet metal rust-through; a variety of flexible plans for financing, leasing and extended service. All of these customer support programs are detailed at right. Customer One Care ... the Chrysler promise you can live with. For years.

CUSTOMER ONE[®]

Chrysler's Investment in Your Satisfaction

THE PRODUCT Chrysler Corporation has created a revolutionary new lineup of cab-forward, next-generation automobiles and minivans. That's product.

THE PEOPLE To market these exceptional new vehicles, Chrysler Corporation and its dealer body have revolutionized the way they do business, committing millions annually to training, educating and increasing the awareness of dealership sales staff and service personnel. That's people.

THE GOAL Together, product and people form a synergistic network dedicated to one goal: exceeding your expectations throughout the shopping, buying and ownership experience. **Sales Advisors** are trained to guide you to the car or minivan that precisely fits your lifestyle. Customer One **Product Training** provides detailed, in-depth information regarding cars and minivans. Product workshops impart not only "book" knowledge but also a hands-on "feel" for the vehicle that is gained through on-the-road experience. In-dealership product training includes ongoing monthly meetings designed to provide the facts on competitive cars and minivans to help Sales Advisors help their customers. **Service personnel** undergo similar training programs designed to continually update their skills and keep them abreast of rapidly advancing automotive technology.

THE RESULTS The results of this massive commitment to continuous improvement are reflected in both products and people: outstanding achievements in sales and increasing Sales and Customer Satisfaction Index scores — two highly controlled systems that **measure our performance** by soliciting your opinion. At Chrysler, we're not just a whole new family of cars, but an entirely new corporate culture dedicated to satisfying your every automotive desire.

CUSTOMER ONE CARE™ All Plymouths are covered by the 3/36 Customer One Care Plan[†] which includes:

■ **A 3-year or 36,000-mile** (whichever comes first) Bumper-to-Bumper Limited Warranty which covers the complete vehicle against defects in factory-supplied materials and workmanship. (This 3/36 warranty excludes tires, wiper blades, clutch and brake linings, brake rotors and drums and normal maintenance items!)

■ **Roadside Assistance for 3 years or 36,000 miles** which provides 24-hour, 7-day-a-week Emergency Road Service, contacted by a 24-hour nationwide toll-free number. Roadside Assistance covers items not included in the 3/36 warranty: lockout, jump start, out-of-gas, change flat tire with your good spare and towing!

■ **The 5-year or 100,000-mile Outer-Panel Rust-Through Limited Warranty** which covers the cost of all parts and labor needed to repair exterior sheet-metal panels perforated by corrosion.

The 3/36 Customer One Care Plan stays with the vehicle, and transfers automatically to subsequent owners at no cost during the warranty period.

^{*}See your dealer for additional details and a copy of this limited warranty.
[†]Tires are covered by their own manufacturers' warranty.
[‡]Roadside Assistance services are provided by Cross Country Motor Club, Inc. (in California, Cross Country Motor Club of California, Inc.).

SERVICE CONTRACTS Additional peace-of-mind protection for vehicle owners is available through optional Chrysler Service Contracts ... **the only one** backed by Chrysler Corporation. These service plans are available in a variety of time and mileage combinations to meet your particular driving needs. Ask your dealer for more information or call 1-800-442-2666.

CHRYSLER FINANCIAL Chrysler Financial offers a broad range of traditional automotive financing plans and flexible terms for qualified buyers. Many of these plans can be customized to fit your particular budget and lifestyle. To make your new vehicle even more affordable, you may want to consider Gold Key Lease and Gold Key Plus short-term financing. Our College Graduate Plans, for example, are especially attractive to those just beginning their careers. Chrysler Financial's programs are subject to availability and state and local laws.

AUTOMOBILITY PROGRAM Cash reimbursement is available for qualified adaptive driving devices. Ask your dealer to provide you with more information or call the **Automobility Program Headquarters** at 1-800-255-9877.

LEASING FOR TODAY'S LIFESTYLES



LEASING IS BECOMING A VERY POPULAR WAY TO DRIVE A NEW VEHICLE. In fact, one out of every four vehicles is leased rather than purchased and the trend is growing. There is nothing confusing or complicated about leasing a vehicle at your dealership. Chrysler Financial's Gold Key Lease has the flexibility to fit your vehicle choice and your lifestyle. If the idea of getting the type of vehicle you really want, more often, and paying less for it sounds great, ask about Gold Key Lease.

GOLD KEY LEASE

Because you pay for the portion of the vehicle you'll use, a Gold Key Lease will help you drive the vehicle you've always wanted.

- **Lower Monthly Payments** Gold Key Lease payments are typically lower than conventional finance payments.
- **Shorter Term** With a Gold Key Lease, you can drive a new vehicle as often as the term of your lease.
- **Flexibility** Gold Key Lease terms and payments can be tailored to fit your driving habits and lifestyle.
- **Three Great Options** A Gold Key Lease offers you three great options at lease end:
1) Turn the vehicle in and lease a new one. 2) Buy the vehicle and keep it. 3) Buy it, then sell it for a possible profit, and lease a new vehicle.

GOLD KEY PLUS

For customers who enjoy the low payments of leasing and want the pride of vehicle ownership, Gold Key Plus is the answer. Simply decide how long you want to drive the vehicle, from one to three years, and its trade-in value at the end of that period is guaranteed. To calculate the amount to be financed, just subtract the guaranteed trade-in value from the purchase price, resulting in significantly lower monthly payments.

COMMERCIAL FINANCE PROGRAM

Chrysler Financial's new Commercial Finance Program offers several finance and lease options to small and midsize businesses, municipalities and small fleet operators. "Line of Credit" financing is also available under this Program. Please see your dealer for details.

All product illustrations and specifications are based upon current information at the time of publication approval. Although descriptions are believed correct, complete accuracy cannot be guaranteed. Chrysler Corporation reserves the right to make changes from time to time, without notice or obligation, in prices, specifications, colors and materials, and to change or discontinue models. See your dealer for the latest information.

Chrysler, Plymouth, Customer One, Mopar, Easy Out Roller Seats and EVS II are registered trademarks, and Neon, Breeze, Prowler, Voyager, Customer One Care and Espresso are trademarks of Chrysler Corporation. Infinity is a registered trademark of Infinity Systems, Inc.

**Always use seat belts. Remember a backseat is the safest place for children.
Rearward-facing child seats cannot be used in Plymouth Prowler.**

**FOR MORE INFORMATION ON PRODUCTS OR LEASING:
1-800-PLYMOUTH
www.plymouthcars.com**

That's Plymouth.®

