

# FORD 1971 ACCESSORIES

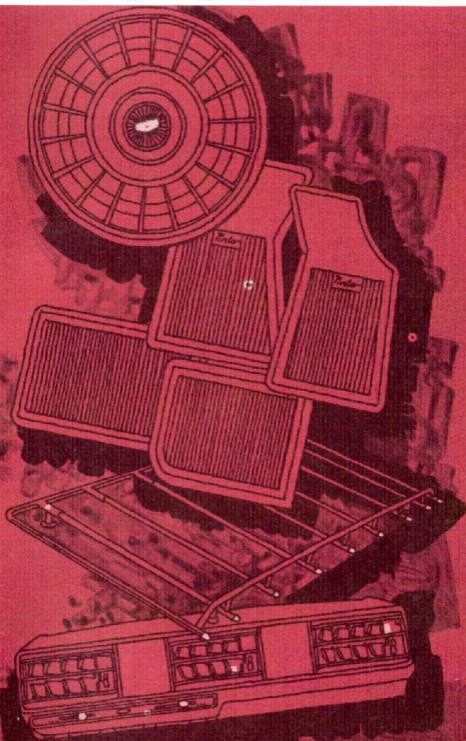

Ford has a better idea



# APPEARANCE & PROTECTION

## WHEEL COVERS

Added fashion with wheel covers from Ford. Give your car wheel appeal with avant garde styling in steel. Wide selection of styles.

### FORD

- a. DELUXE 15" — full cover — DIAZ 1130-A

### TORINO

- b. DELUXE 14" — vaned full cover — DOOZ 1130-A

### MUSTANG

- c. DELUXE 14" — simulated mag. — 3 wheel sizes — DIZZ 1130 — C, D, E

### MAVERICK

- d. DELUXE 14" — full cover — in top style — DODZ 1130-E

### PINTO

- e. DELUXE — full cover — DIFZ 1130-B

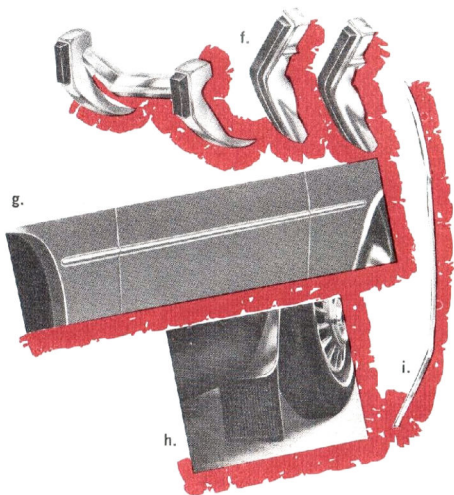
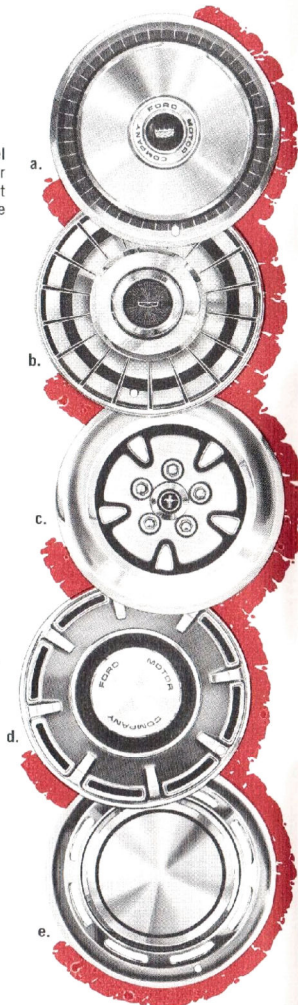

- f. **BUMPER GUARDS**—Gives polish and safeguard to front and rear bumpers. Heavy gauge chrome-plated steel with rubber inserts for extra shock absorption.

FORD (illustrated). ALL MODELS. Front, Basic Part No. 17996; Rear (except S/W) Basic Part No. 17984

TORINO, MAVERICK, MUSTANG, PINTO (not shown)—Front, Basic Part No. 17996; Rear, Basic Part No. 17984

- g. **BODY SIDE MOULDINGS**—Stops paint chipping from another car door. Metal with vinyl. FORD, TORINO, MUSTANG, PINTO, THUNDERBIRD. Basic Part No. 21048. 38" Roll Vinyl self-adhering moulding. ALL MODELS—D0A7 6221048-B
- h. **WHEEL SPLASH GUARDS**—Keeps mud and road splash off your car. ALL MODELS—D0ZZ 16A550-A
- i. **DOOR EDGE GUARDS**—The final touch for styling your car doors. Small chrome strip gives spark while guarding door edges from chips. ALL MODELS—Basic Part No. 20910

# FLOOR MATS

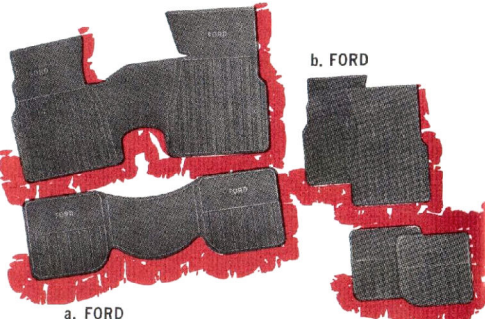

a. FORD

b. FORD

Protect your car interior with newest designer floor mats by Ford. Color—blend or contrast.

**FORD**—rubber mats... black, blue, white, red, ivy gold, aqua, nugget.

a. FULL FRONT—Basic Part No. 6513086, FULL REAR—Basic Part No. 6513106

b. TWO-PIECE FRONT—Basic Part No. 6213086, TWO-PIECE REAR—Basic Part No. 6213106

**MUSTANG**—rubber mats with Mustang Crest... black, white, red, blue, ginger, ivy gold.

c. TWO-PIECE FRONT—Basic Part No. 6513086, TWO-PIECE REAR—Basic Part No. 6513106

**THUNDERBIRD**—rubber mats with Thunderbird Crest... black, white, blue, red, ivy gold, nugget.

d. TWO-PIECE FRONT—Basic Part No. 6313086, TWO-PIECE REAR—Basic Part No. 6313106

**TORINO**—rubber mats with outline for converting into two-piece mats... black, blue, red, ivy gold, nugget, aqua, white.

e. FULL-FRONT—Basic Part No. 5413086, FULL REAR—Basic Part No. 5413106

**ALL MODELS**—with outline for converting into two-piece mats.

f. **UNIVERSAL OPAQUE VINYL**... black, blue, white, red, ivy gold.

**UNIVERSAL TRANSPARENT VINYL** (not shown)... clear, red, blue, black, ivy gold.

FULL FRONT—Basic Part No. 6213086, FULL REAR—Basic Part No. 6213106

**UNIVERSAL OPAQUE VINYL**... (not shown): black, blue, green, red, white (Car set)—TWO-PIECE FRONT, TWO-PIECE REAR—Basic Part No. 6213088

c. MUSTANG



d. THUNDERBIRD

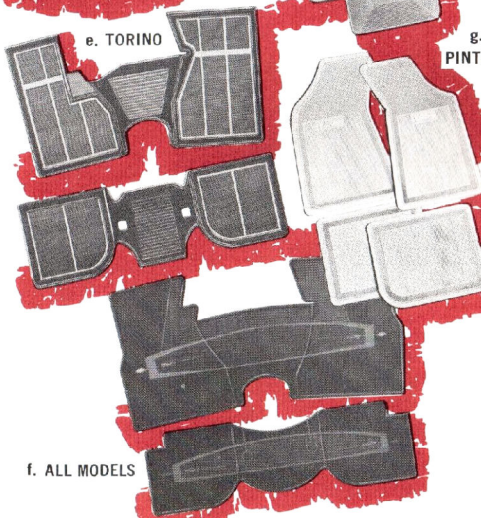

e. TORINO

g. PINTO

f. ALL MODELS

**PINTO**—rubber mats... black, blue, white, gold, with Pinto Crest.

g. TWO-PIECE FRONT—Basic Part No. 6213086, TWO-PIECE REAR—Basic Part No. 6213106

**ECONOMY RUBBER** (not shown)... black, white, red, blue.

FULL-FRONT—Basic Part No. 6213086, TWO-PIECE REAR—Basic Part No. 6213106

# AIR CONDITIONERS

a. FORD

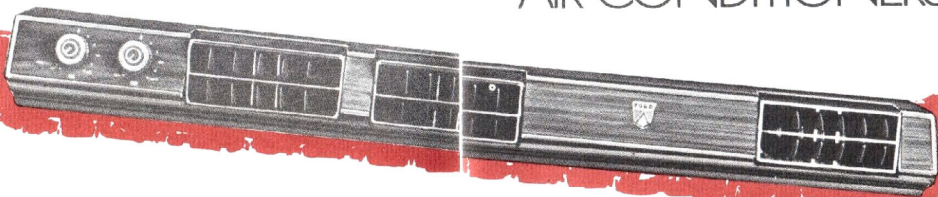

b. TORINO

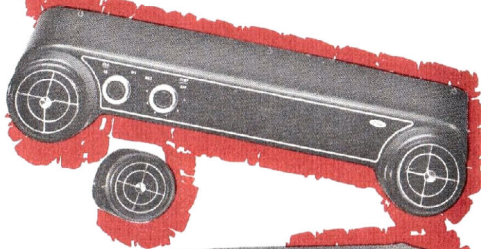

c. MUSTANG, MAVERICK



d. PINTO, MAVERICK

For cool summer driving. Air-condition your Ford interior. Simple installation and added trade-in value. All Ford dealers service them.

Enjoy instant cool-off with high cooling output and quiet operation. Precision-built exclusively for your Ford.

- a. **FORD** . . . New deluxe slimline style.
- b. **TORINO** . . . Deluxe slimline style.
- c. **MUSTANG, MAVERICK** . . . Deluxe model including left-hand outlet. Right-hand mount.
- d. **PINTO, MAVERICK** . . . New compact design. • Center Mount.

## ALL MODELS FEATURE:

- **WIDE-RANGE BLOWER SPEEDS**—Highest air flow for speedy cool-down. Supplies lower speeds for complete motoring comfort.
- **COMFORT-LEVEL SELECTION**—Adjust to temperature range that you prefer.

# SOUND EQUIPMENT

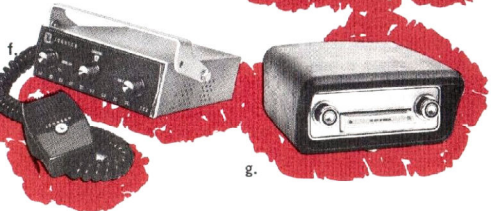
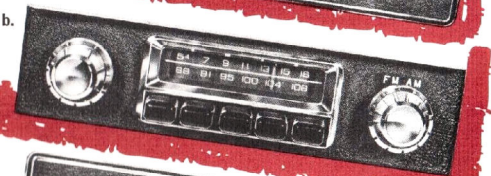

a. **AM/FM STEREO RADIO**—If you like fine music equip your car with superior sound. This instrument plays true stereo programs. FORD, TORINO, MUSTANG, THUNDERBIRD—Basic Part No. 18805

b. **AM/FM RADIO**—Excellent receiving with high performance. Finest FM sound. MAVERICK, PINTO—Basic Part No. 18805

c. **AM RADIO/STEREO TAPE SYSTEM**—When you want the most in music. A complete sound set up in your instrument panel. FORD, THUNDERBIRD, MUSTANG—Basic Part No. 18805

**AM RADIO** (not shown)—All transistor, push button stations, lighted dial. ALL MODELS—Basic Part No. 18805 (except Thunderbird)

d. **REAR SEAT SPEAKERS**—Come dual or single. Add dimensional sound to your system. ALL MODELS—Basic Part No. 18875

e. **TWO-WAY RADIO**—6 channel transceiver. Communicate as you travel. ALL MODEL S—C9AZ 18805-B  
Converts to base station by adding power supply. Part No. C9AZ 18800-A (not shown)

f. **TWO-WAY RADIO**—12 channel transceiver. ALL MODELS—C9AZ 18805-C. Can convert to base station by adding power supply—C9AZ 18800-B (not shown). Also available is 12 channel power supply recharge battery, C9AZ 18800-D (not shown) and tone alert, C9AZ 18801-A (not shown).

g. **STEREO TAPE PLAYER**—Make up your own programs with this compact outfit. Super sound. (ALL MODELS). C8AZ 19A035-A Mounts on tunnel. (Not available with console, 4-speed transmission or hang-on A/C). Front and rear speakers are separate. Basic Part Nos. 18808 and 18875. Tape player support kit also required. Basic Part No. 19A112

**ANTENNA KITS—TWO-WAY RADIO** (not shown). C9AZ 18813-B—Base station type; C9AZ 18813-C—Gutter clamp type; C9AZ 18813-D—Magnetic mount type.

**ELECTRIC ANTENNA** (not shown)—A convenience item with remote control operating. Optimum reception. ALL MODELS. Basic Part No. 18813

**FORD STEREO 8 TAPE CLUB**—Outstanding tapes at savings to you. Write Ford Stereo 8 Tape Club, Box 26888, Lawrence, Indiana 46216, for information.

b.

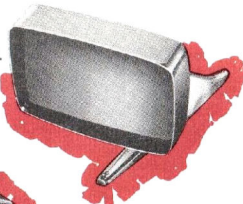

a.

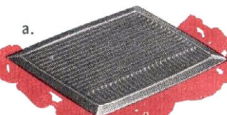

c.

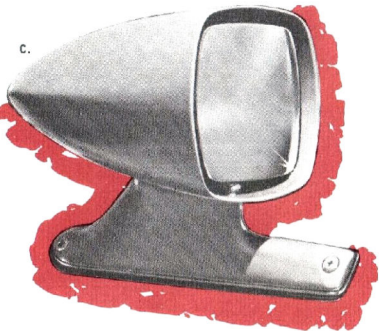

d.

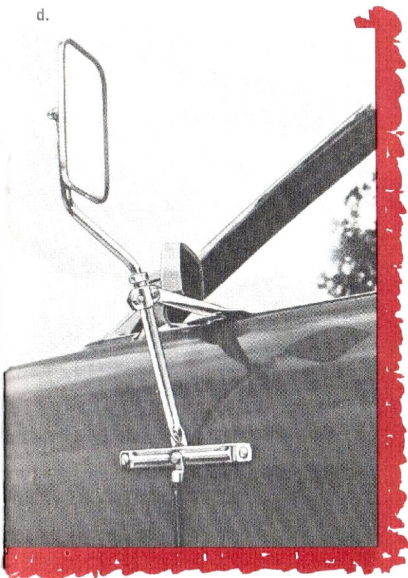

a. **REAR WINDOW DEFOGGER**—A must for safety. Keeps rear window fog-free. Designed to blend with interior. FORD, TORINO, MUSTANG (Sedans & Hardtops) MAVERICK—C8AZ 18397-A

b. **LEFT-HAND REMOTE CONTROL MIRROR**—Easy inside adjusting for best viewing angles. FORD, TORINO, MUSTANG, MAVERICK, —Basic Part No. 17696.

**RIGHT-HAND MANUAL MIRROR** to match L.H. Remote (not shown). FORD, TORINO—C9AZ 17696-A. **RIGHT-HAND MANUAL MIRROR** to match standard L.H. Manual (not shown)—FORD, TORINO—D0AZ 17696-B

c. **DUAL RACING MIRRORS**—For those who want the sporty look. Air-flow design with personal adjustment from within your car on left-hand mirror. Available as set only, left-hand remote control and right hand manual. TORINO, MAVERICK, MUSTANG, PINTO (L.H. only)—Basic Part No. 17696

d. **TRAILER TOWING MIRROR**—Wide viewing surface. ALL MODELS —C7AZ 17696-D

**DAY-NITE MIRROR** (not shown)—Eliminates rear glare with fast switch lever. Another safety must. MAVERICK, PINTO—Basic Part No. 17700-A

**VANITY MIRROR** (not shown) A necessity for the lady traveler. This handy mirror fastens on back of visor. ALL MODELS—C6AZ 17A679-A

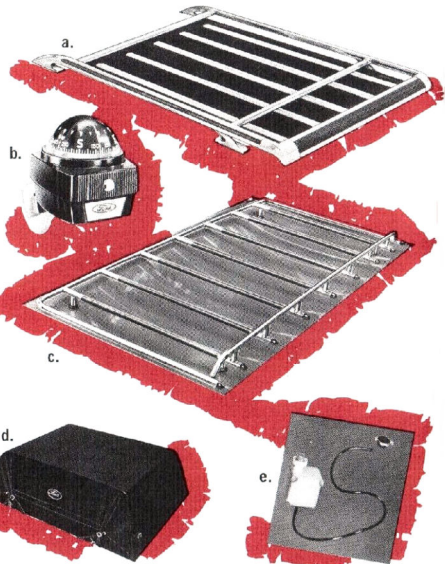

- a. **DELUXE STATION WAGON LUGGAGE RACK**—A handsome utility item for the travel buff. Luggage room to spare. Designed-in air deflector. ALL MODELS—Basic Part No. 55100. Standard non-adjustable luggage rack is available also. (not shown). Basic Part No. 55100

**PINTO LUGGAGE RACK** (not shown)—Designed for carrying that extra gear. PINTO—Basic Part No. 55100

- b. **COMPASS**—Stay on course as you go. Lights up for night travel. ALL MODELS—C9AZ 19A548-A
- c. **REAR DECK LUGGAGE RACK**—Gain luggage space and add accent to rear deck line. ALL MODELS (except Mustang and Torino Fastbacks): C9AZ 6255100-A (straps available for temporary hook-up, Maverick only—D0DZ 6255196-A)
- d. **LUGGAGE RACK COVER**—All S/W—Gets you there and back with luggage high-and-dry. Dressy, strong vinyl. Basic Part No. 19B507
- e. **COOLANT RECOVERY SYSTEM**—Newest item for assuring maximum cooling. Stores overflow radiator coolant and returns it to radiator for re-use after pressure is reduced. Connects easily to cooling system. ALL MODELS—DOAZ 8522-A

- f. **ADJUSTABLE AIR SPRINGS**—Air cells give extra support for your touring luxury. Utility Air Level Ride Control mounts on dash. FORD, THUNDERBIRD—C8AZ 5A589-A; and C9AZ 5A589-B Air Level Dash Control only.
- g. **TRAILER HITCH**—A camper, light trailer, or small boat owner necessary. (SAE Class 1, for trailers up to 2000 lbs.) ALL MODELS except Pinto—Basic Part No. 190520 (Use Trailer Hitch Ball—Basic Part No. 19F503.)
- h. **TRAILER WIRING CONNECTOR KIT**—ALL MODELS except Pinto C7AZ 14A347-A. TRAILER WIRING HARNESS—Dependable hook-up for any trailer. Equipped with relays that prevent circuit overload.—ALL MODELS except Pinto—C7AZ 15A416-A

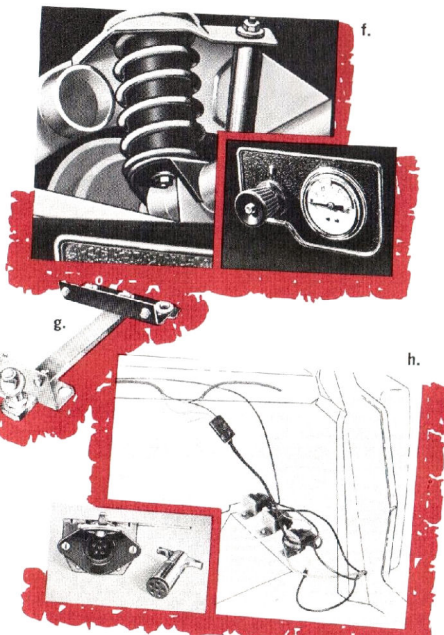

# CONVENIENCE /SAFETY

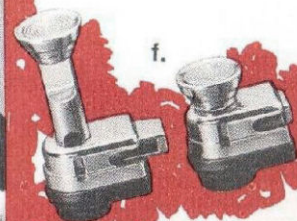
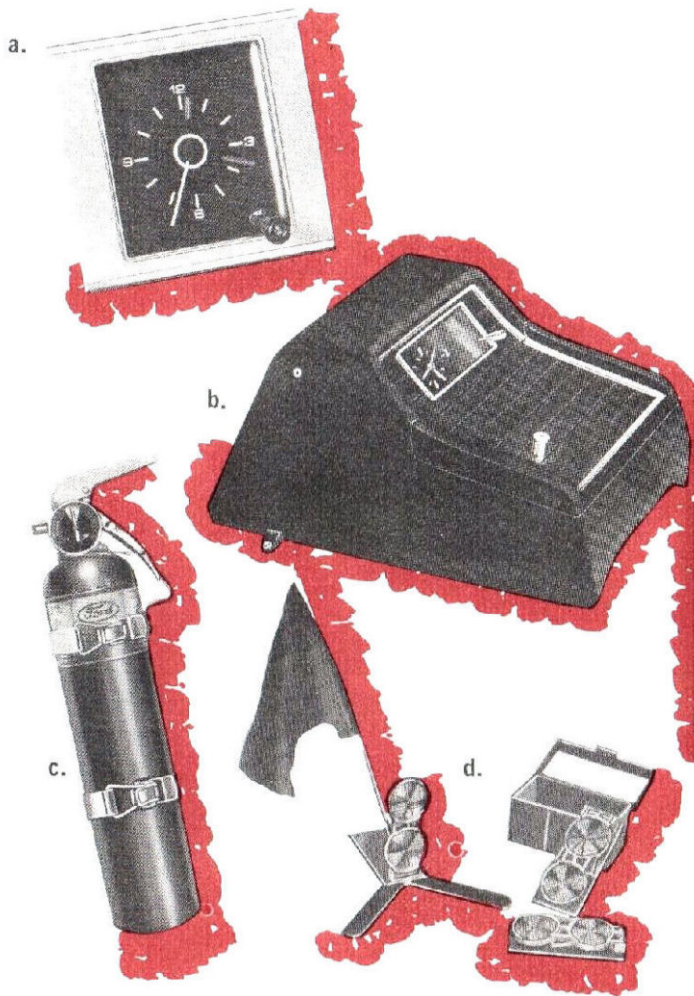

- a. ELECTRIC CLOCK**—Attractive instrument for reliable time. Automatic self-regulator feature. FORD, TORINO, MUSTANG—Basic Part No. 15A000
- b. CONSOLE/CLOCK**—A style note for your Maverick or Pinto with this newest accessory. Adds lock-up storage room and self-regulating clock for fast time checks. MAVERICK, PINTO—Basic Part No. 15A000
- c. FIRE EXTINGUISHER**—Every car, boat or home needs one. Filled with dry chemical. ALL MODELS—2¾ lbs.—C9AZ 19B540-B; 5 lbs.—C9AZ 19B540-A. Extra recharge kits. Basic Part No. 19C505
- d. EMERGENCY REFLECTOR FLARE KIT**—Bright warning for safety in emergency stops, night or day. Compact kit contains 3 reflector-flag set-ups. Holds in 40 mph wind. ALL MODELS—C5AZ 19E500-D

**e. CHILD'S TOT GUARD SAFETY SEAT**—For the tot traveler. New safety guard from Ford, protects kiddies up to 50 pounds. Heavy padding guards upper body. Form-fitting to hold tots in place. Fastens speedily on car seat with regular seat belt. Washable. ALL MODELS—C8AZ 19E535-A

**f. LIFEGUARD JUNIOR DOOR LOCKS**—Safety for the little ones. Keeps rear doors locked. Opens only by key. 4-DOOR MODELS—C6AZ 5421850-B

**g. REMOTE CONTROL TRUNK LID RELEASE (ELECTRIC)**—A great convenience accessory. Open trunk while inside your car. FORD, TORINO, MUSTANG, MAVERICK, PINTO. C9AZ 54432A00-A

**CIGAR LIGHTER** (not shown)—Handy item for the smoking motorist. PINTO—Basic Part No. 15A044

**POWER STEERING** (not shown)—Steering ease with finger tip control. Effortless, fast steering from Ford. ALL MODELS except Pinto. Basic Part No. 3A634 and 3A635

**POWER BRAKES** (not shown)—For speedy, safer, effortless braking. FORD, TORINO, MUSTANG—Basic Part No. 2A091 (Drum brake design).



# SPECIAL ACCESSORIES

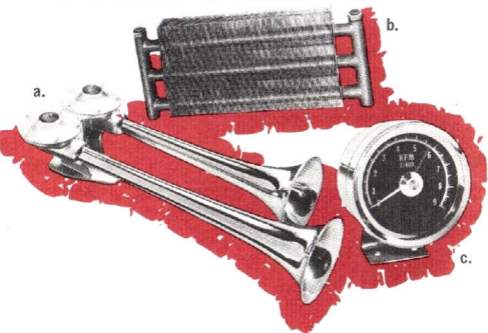

a. **AIR HORNS**—Get attention on the road. Sound off loud and clear. Ideal for expressway going. Chrome plated dual horns with compressor. ALL MODELS—DOAZ 13800-A

b. **TRANSMISSION OIL COOLER**—(for use on V-8 engines with automatic transmissions) Allows top performance of transmissions under high speed stress when pulling trailers or heavy loads. Extends life of transmission by keeping fluids cool. C9AZ 7K177-A

c. **TACHOMETER (Round)**—Keep closer touch with your engine, as you go. Accurate recording of engine performance.

8 Cylinder Ford—9000 RPM Round Tach, 250° dial—C6AZ 17A326-G  
—8 Cylinder Ford—6000 RPM Economy Round Tach, 100° dial (not shown)—C6AZ 17A326-D

**SPOTLIGHT** (not shown)—Light where you want it. Inside operation. (Shaft-type). Does not apply to hardtops. FORD (SEDANS), TORINO, MAVERICK—RH, Basic Part No. 15312; LH, Basic Part No. 15313

NOTE: Descriptions and specifications contained in this catalog were in effect at the time this publication was approved for printing, and are subject to change without notice or liability therefor. The Autolite-Ford Parts Division of Ford Marketing Corporation reserves the right to change or discontinue options or accessories at any time.



**Autolite-Ford Parts Division**