

1981



AMERICAN MOTORS CORPORATION

SPIRIT

CONCORD

1981 Spirit • Concord

American Motors is proud of its proven record as a pioneer manufacturer of small cars with built-in quality. Our past performance has also become a present and future commitment: to build the kinds of cars that are oriented to consumer needs; and to build cars that give American buyers a full quota of lasting value and comfort.

For 1981, American Motors has once again embodied this commitment to economy and value in the new AMC Spirit and Concord automobiles.

With Ziebart® Factory Rust Protection with galvanized steel on the inside of all exterior body panels.

With a full, 5-year No Rust-Thru® Warranty.

And a full 12-month/12,000-mile New Automobile Warranty.

It's all part of the new 1981 Buyer Protection Plan from American Motors. And it's all yours at no extra cost in every new AMC Spirit and Concord.

Tough fuel-efficient American economy cars.

The 1981 Spirit . . . for those who desire a subcompact car that gives exceptional economy with no sacrifice in sporty good looks. The new Spirit comes in two bodystyles: the liftback and sedan, with a special G. T. package available in the liftback.

The 1981 Concord . . . a superior value loaded with standard luxury features and appointments for car-buyers who need

compact size paired with fuel efficiency. Concord offers three popular choices: 2-door sedan, 4-door sedan and 4-door wagon.

Both the Spirit and the Concord boast new improvements in styling and driveability. A distinctive re-designed grille. New deluxe-grained vinyl interiors. Glass-belted radial tires standard. Improved optional 4.2 liter 6-cylinder engine. Expanded choice of options and accessories. Eight new color selections. Just a few of the many value-keyed features built-in for 1981.

And, of course, all Spirit and Concord models come with American Motors' exclusive Buyer Protection Plan for that added peace of mind.

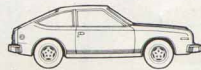

Spirit liftback



Spirit sedan

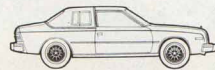

Concord 2-door sedan



Concord 4-door sedan



Concord wagon



Spirit G. T. liftback



Concord DL wagon



Spirit DL liftback

Spirit

When the AMC Spirit moves you... it does it the way a tough, sporty subcompact should.

Go with the Spirit liftback. Its convenient rear hatch opens into a spacious compartment that handles surprisingly large loads. The passenger seating is functional and comfortable. And, you can avail yourself of extra Spirit action with the liftback G.T. package. Special blackout accents, spoke-styled wheels and glass-belted radials outside. A functional tachometer and sport steering wheel inside.

The sedan's practicality is made-to-order for families and singles alike. A folding rear seat affords extra space for storage. As with all Spirit models, you enjoy a smooth, stable ride due to a wide track and long wheelbase.

The new Spirits give you fresh styling features, too, highlighted by new grille and rally stripe designs. You can also lift your Spirit to a higher level of luxury by choosing the optional DL model.

In the city or on the highway, you benefit from fuel efficiency and long-range cruising capability. A responsive 2.5 liter 4-cylinder, 4-speed manual transmission and 21-gallon fuel tank are standard. EPA ratings for the 4-cylinder engine and standard transmission:

②Estimated mpg: 33 highway est. Use EPA est. MPG for comparison. Your mileage may vary with speed, weather, trip length. Actual highway will probably be less. Calif. ests. may vary. Powertrain options include the improved 4.2 liter 6 cylinder engine and 3-speed automatic transmission.

Here's something guaranteed to keep your Spirit high on the value list: the 1981 Buyer Protection Plan. With full 12-month/12,000-mile New Automobile Warranty, Ziebart® Factory Rust Protection with galvanized steel on the inside of all exterior body panels, and AMC's full 5-year No Rust-Thru™ Warranty.

Spirit... One Tough American Economy Car.



Top: Spirit liftback

Spirit DL sedan

Inside Spirit

Choose a Spirit for its substance or its style, and get a full measure of both. Spirit interiors, in particular, are better equipped and appointed than those in many other small cars. Driver and passenger comfort are assured with standard custom bucket seats in Deluxe Grain vinyl and 12 oz. carpeting throughout. Available colors include: black, blue and beige.

Deluxe Grain vinyl
(black, blue, beige, nutmeg)



Coventry Check fabric
(black, blue, beige, nutmeg)

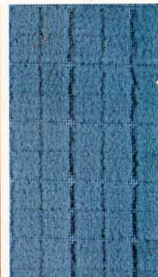

Select the Spirit DL model and relax in the luxury of custom reclining bucket seats in Deluxe Grain vinyl, custom door trim panels, electronic quartz digital clock and a lot more at no extra cost. Available DL interior colors: black, blue, beige and nutmeg.



For elegant handling, choose Spirit's new optional leather-covered sport steering wheel, functional gauge package, floor-shift console and air conditioning.



If your preference is fabric, choose the DL model with reclining bucket seats in Coventry Check. Colors include black, blue, beige and nutmeg.

Concord

More than ever, the new Concord's for '81 are an American Motors success story. They're big enough for most families, yet small enough to fit a small garage, a tight parking space, and almost any pocketbook. And they're built to meet today's motoring needs for fuel-efficient operation and for standard

luxury and handling ease. Take a new Concord shopping, take it vacationing and take the family along.

There's the '81 Concord 2-door sedan, dollar for dollar an outstanding value — whether you choose the surprisingly well appointed base model or step up to DL or Limited luxury and comfort.

The roomy Concord 4-door sedan model blends practical size with elegant styling, and remarkable interior room and appointments. The new Concord wagon is efficiently designed for maximum space to

accommodate cargo and passengers. Yet, there's no sacrifice in luxury and good looks. To pack your gear or groceries into a spacious 57 cubic feet of stowage area, just lower the fold-down rear seat. There's even a hidden cargo compartment for tucking away valuables.

You can treat yourself to higher standards of luxury, too, by selecting the DL or Limited models. Both sedans offer a distinctive opera window treatment for '81. The DL models include newly-styled stainless steel wheel covers along with a host of additional luxury

features. The ultimate Concord is certainly the Limited... with new wire wheel covers, genuine leather interior and elegant appointments throughout the car.

In tune with all AMC cars, the Concord's earn top ratings for fuel efficiency and cruising range. The standard powertrain is the 2.5 liter 4-cylinder engine and 4-speed manual transmission. EPA ratings (23 estimated mpg; 34 highway est. Use EPA est. MPG for comparison. Your mileage may vary with speed, weather, trip length. Actual highway will probably be less. Calif. ests. may vary.

A 22-gallon fuel tank lets you go long distances between gas stops. Optional power includes the improved 4.2 liter 6-cylinder engine and 3-speed automatic transmission.

Drive the Concord of your choice and you're covered by the 1981 Buyer Protection Plan. It includes Ziebart® Factory Rust Protection with galvanized steel on the inside of all exterior body panels. Full five-year No Rust-Thru® Warranty. And a full 12-month/12,000-mile New Automobile Warranty.

Concord... One Tough American Economy Car.



Concord Limited 2-door sedan



Top: Concord DL 4-door sedan



Concord DL wagon

Inside Concord

The true sense of family-sized luxury and convenience are revealed in the tastefully appointed Concord interiors. The high quality of interior trim is evident everywhere . . . in the handsome door panels, in the deep-pile, color-keyed carpeting, in the comfortable contoured seating. A long list of interior options is available to raise the level of luxury even higher.

Individual sculptured Rochelle Velour fabric seats are an elegant option on DL models. Five color choices include black, blue, wine, beige and nutmeg.

Standard Concord instrument panel with woodgrain accents; custom color-keyed steering wheel.

Concord DL interior with individual reclining front seats in optional sculptured Rochelle Velour fabric.

Deluxe Grain vinyl
(black, blue, beige, nutmeg).

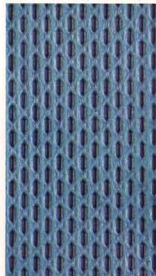

Sculptured Rochelle
Velour fabric
(black, blue, wine,
beige, nutmeg).



Leather (nutmeg).



Concord's optional Limited model comes with individual reclining, genuine leather seats in nutmeg, plus 18 oz. carpeting, luxury woodgrain steering wheel and more.



Color-keyed carpeting and lockable stowage compartment enhance the utility of the 57-cubic-foot cargo area (with rear-seat folded down) in Concord wagons.



Spirit·Concord Options & Accessories

Some options listed are standard on DL or Limited models or are included in select packages.

Power

- Power steering
- Power front disc brakes
- Power lift side windows (DL and Limited models)
- Power door locks (DL and Limited models)
- Six-way power driver's seat (Concord DL and Limited models)
- Six-way power driver's and passenger's seats (Concord DL and Limited models)
- Power decklid release (Concord sedans)
- Power liftback release (Spirit liftback)

Audio

- AM radio
- AM/FM stereo radio
- AM/FM cassette stereo radio
- AM/FM/CD stereo radio
- Premium audio system
- Power antenna

Convenience

- Air conditioning system (includes heavy duty cooling system, heavy duty alternator and parcel shelf)
- Air conditioning package (includes air conditioning system as above plus power steering and tinted glass)
- Light group (includes dome/map light, two courtesy lights, glove box light, engine compartment light, rear door dome light switches, trunk light on sedans and liftgate dome light switch on liftbacks and wagons)
- Convenience group (includes lighted passenger visor mirror, lights-on buzzer and intermittent windshield wipers)

- Gauge package (includes tachometer, clock, ammeter, oil and vacuum pressure gauges)
- Quartz digital clock
- Tinted glass
- Rear window defogger
- Rear window wiper and washer (liftback and wagon models)
- Pop-up sun roof
- Dual horns
- Cruise control (automatic transmission only)
- Tilt steering wheel
- Roof rack
- Tailgate air deflector (Spirit)
- Full-length console with armrest (Spirit)
- Halogen headlamps
- Parcel shelf
- Remote control outside sport mirrors (Spirit)
- Remote control outside chrome mirrors
- Electric control outside chrome mirrors
- 10-inch day/night mirror

Appearance

- Spirit G.T. Package includes the following equipment:
Interior — color-keyed sport steering wheel
- Exterior — spoke styled wheels; black dual remote sport mirrors; black bumpers with nerf strips and guards; European blackout exterior accents on grille, trim moldings, venturi area and taillamps; dual black paint stripes (color-keyed with black exterior paint); G.T. medallions
- Functional — P185/75 R14 radial BSW tires (DL model); tachometer
- Two-tone paint
- Woodgrain bodyside panels (wagons)
- Rally stripes (Spirit)
- Rear spoiler (with Spirit G.T. package only)
- Luxury woodgrain steering wheel

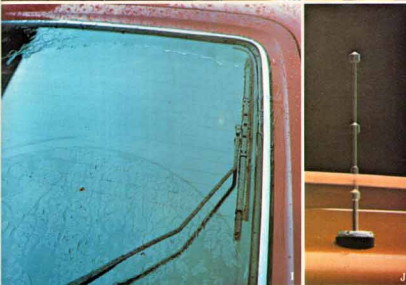
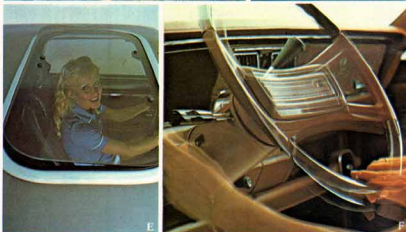

Factory Approved AMC Parts/Accessories

Always insist on the use of genuine AMC replacement parts to help maintain the high standard of quality built into all AMC vehicles.

And, be sure you select from the vast line-up of factory-approved accessories for dealer installation to personalize your vehicle to suit your driving needs. Because AMC

parts and accessories are designed and engineered specifically for AMC vehicles, they will fit correctly, perform properly and give long-lasting satisfaction. Genuine AMC parts and accessories are available only through your local AMC dealer.

Ask him for the latest copy of the AMC Accessory Catalog.

- Leather wrapped sport steering wheel
- Vinyl sport steering wheel (Spirit)

Wheel Trim

- Styled wheel covers
- Wire wheel covers
- Spoke style wheels
- Turbocast II aluminum wheels

Protection

- Protection group (includes bumper nerf strips and guards, door edge guards and floor mats)
- Bumper guards
- Extra quiet insulation
- Locking gas cap
- Bodyside scuff moldings (Spirit only)
- Retractable cargo area cover (wagons)

Heavy Duty

- Handling package (includes unique front and rear sway bars)
- Heavy duty shock absorbers
- Automatic load leveling air shocks (Concord)
- G.T. rally tuned suspension (Spirit liftback only; includes uniquely tuned front sway bar, rear sway bar, heavy duty adjustable Gabriel Strider shock absorbers, tuned strut rod bushings, tuned rear spring iso-clamp pads, hi-control rear leaf springs and unique steering gear)
- Light duty trailer towing package (Concord only; includes

bumper-mounted hitch, 5-connector wiring harness and vehicle to trailer wiring kit. For trailers up to 2000 pounds)

- Twin Grip differential
- Cold climate group (includes engine block heater, heavy duty battery and coolant protection)
- Heavy duty battery
- Altitude option
- 4-cylinder heavy duty cooling system (includes heavy duty radiator and viscous drive fan)
- 6-cylinder heavy duty cooling system (includes heavy duty radiator, viscous drive fan, fan shroud and coolant recovery system)

Tires

- P185/75R14 fiberglass radial WSW (Spirit only)
- P195/75R14 fiberglass radial BSW (Spirit only)
- P195/75R14 fiberglass radial WSW
- P195/75R14 Arriva steel radial WSW
- P195/70R14 Wing Foot Flexten radial RWL

- A Premium audio system
- B AM/FM cassette stereo radio
- C Lighted passenger visor mirror
- D Cruise control
- E Pop-up sun roof
- F Tilt steering wheel
- G Six-way power driver's seat
- H Power lift side windows
- I Rear window wiper and washer
- J Power antenna
- K Retractable cargo area cover

Spirit • Concord

Standard Features

Spirit and Concord base models offer the following standard equipment:

Functional

- 2.5 Liter, 4-cylinder engine
- 4-speed manual transmission
- Manual front disc brakes
- P185/75R14 radial BSW tires (Spirit)
- P195/75R14 radial BSW tires (Concord)
- 21 gallon fuel tank (Spirit)
- 22 gallon fuel tank (Concord)
- Front stabilizer bar
- High level ventilation
- Heater/defroster system
- High-pressure compact spare tire

Exterior

- Full wheel covers
- Dual body-side pinstrips
- Bright exterior moldings including: rocker, drip, wheeliepl, windshield surround

1981 AMC EPA FUEL ECONOMY FIGURES

SPIRIT	49 States		California	
	Est. MPG/ Highway	Est. MPG/ Highway	Est. MPG/ Highway	Est. MPG/ Highway
4-cylinder 4-speed automatic	20/26	21/28	20/26	21/28
6-cylinder 4-speed automatic	19/28	19/26	19/28	19/26
CONCORD				
4-cylinder 4-speed automatic	23/34	23/31	23/34	23/31
6-cylinder 4-speed automatic	20/26	19/28	20/26	19/26

DIMENSIONS/CAPACITIES

	Spirit		Concord	
	liftback sedan	2-door	4-door wagon	4-door wagon
EXTERIOR				
Wheelbase	96.0	96.0	108.0	108.0
Overall Length	167.2	167.0	185.0	185.0
Overall Width	71.3	72.0	71.0	71.0
Overall Height	51.5	51.6	51.9	51.3
Front Overhang	35.4	35.4	35.4	35.4
Rear Overhang	35.9	35.6	41.6	41.6
Front Track	58.1	58.1	57.6	57.6
Rear Track	57.0	57.0	57.1	57.1
INTERIOR				
Front Leg Room	40.8	40.8	40.8	40.8
Front Head Room	38.1	38.1	38.1	38.1
Front Shoulder Room	53.9	53.9	54.0	54.0
Front Hip Room	54.3	54.3	54.4	54.4
Rear Leg Room	26.2	25.7	36.1	36.1
Rear Head Room	35.6	37.7	37.5	37.9
Rear Shoulder Room	53.2	53.0	53.2	53.4
Rear Hip Room	40.3	43.5	42.5	43.6
Cargo Index Volumes (Cu. Ft.)	25.5	27.3	11.4	11.4
Cargo Lifterover Height (ft. Design Weight)	28.7	29.8	28.1	27.2
Fuel Capacity (Gallons)				
4-Cylinder	21	21	22	22
6-Cylinder	21	21	22	22
Curb Weight — Base	2665	2621	2756	2822

NOTE: 3.8 cubic feet of hidden cargo volume on Concord Wagons.

- Bodyside scuff moldings (Concord)
- Left rearview mirror
- Quad rectangular headlamps

Interior

- Custom bucket seats in vinyl (Spirit)
- Contoured bench seat in vinyl (Concord)
- Custom door trim panels
- Color-keyed 12 ounce carpeting in passenger area
- Cargo area carpeting (Spirit liftback and sedan; Concord wagon)
- Custom color-keyed steering wheel
- 8" rearview mirror
- Inside hood release
- Glove box lock
- Lighted ashtray — front
- Cigarette lighter
- Dome light
- Parking brake warning light

- Key warning buzzer (Spirit)
- Lockable cargo compartment (Concord wagon)
- Fold-down rear seat (Spirit liftback and sedan; Concord wagon)

Spirit and Concord DL models offer the following equipment in addition to or in place of base model equipment:

Functional

- WSW tires
- Extra quilt insulation
- AM radio (Spirit)
- Dual horns

Exterior

- Full styled wheel covers
- Inside hood release
- Vinyl roof with opera windows (Concord sedans)
- Woodgrain side panels (Concord wagon)
- Deluxe exterior moldings
- Bumper guards — front and rear
- Additional body-accent pinstripping (Concord 4-door sedan and wagon)
- DL exterior identification

Interior

- Reclining bucket seats in Deluxe Grain vinyl (Spirit)
- Individual reclining seats in Deluxe Grain vinyl (Concord)
- Split folding rear seat (Spirit)
- Premium door trim panels with woodgrain accents
- Woodgrain instrument panel overlay
- Quartz digital clock
- Custom steering wheel with woodgrain accents
- 10" day/night mirror
- Rear seat ashtrays (Concord)
- Cargo skid strips (Concord wagon)
- Trunk carpeting (Concord sedans)

ENGINE/TRANSMISSION/AXLES AVAILABILITY

Engine/Transmission	49 States & Canada		High Altitude
	California	California	
SPIRIT			
Axle Ratios			
2.5 Liter (151 CID) 2V 4-Cylinder			
4-Speed Man. Floor	3.08 S	3.08 S	3.08 S
3-Speed Auto. Column	3.08	3.08	3.08
3-Speed Auto. Floor	3.08	3.08	3.08
4.2 Liter (258 CID) 2V 6-Cylinder			
4-Speed Man. Floor	2.37	2.37	2.53
3-Speed Auto. Column	2.53	2.53	2.73
3-Speed Auto. Floor	2.53	2.53	2.73
CONCORD			
Axle Ratios			
2.5 Liter (151 CID) 2V 4-Cylinder			
4-Speed Floor	3.08 S	3.08 S	3.08 S
3-Speed Auto. Column	3.08	3.08	3.08
4.2 Liter (258 CID) 2V 6-Cylinder			
4-Speed Floor	2.37	2.37	2.53
3-Speed Auto. Column	2.53	2.53	2.73

S — Standard engine/transmission/axle combination

California Requirements

As in the past, vehicles destined for sale and registration in California must be equipped with the optional "California Emission System and Factory Testing"

1981 AMC Full 12-Month/12,000-Mile New Automobile Warranty

When you buy a new 1981 AMC automobile from an AMC dealer, American Motors Corporation** warrants to you that for 12 months or 12,000 miles* from the date of delivery or first use, whichever comes first, it will, except for tires, pay for the repair or replacement of any part it supplies which proves defective in material or workmanship.

All we require is that the automobile be properly maintained and cared for under normal use and service in the fifty United States or Canada and that warranty repairs or replacements be made by an authorized AMC dealer.

Except for other written warranties issued by American Motors applica-

ble to AMC vehicles no other warranty gives you specific legal rights, and you may also have other rights which vary from state to state or province to province.

*In Canada: (20,000 km)

**In Canada: American Motors (Canada) Limited

Ziebart® Factory Rust Protection and Full Five (5) Year Perforation from Corrosion Warranty

When you buy a new 1981 AMC automobile with Ziebart® Factory Rust Protection from an authorized AMC dealer, American Motors Corporation warrants to you that it will pay for the repair or replacement of any part it supplies, except exhaust system components, which proves under normal use and service to have developed perforation from corrosion within five (5) years from the date of delivery or first use, whichever occurs first. There is no mileage limitation.

All we require is that the automobile be properly maintained in accordance with the conditions set forth in the Owner's Manual. All repairs and

parts replacements under this warranty must be performed by an authorized AMC dealer. You must notify your dealer as soon as you are aware of perforation due to corrosion.

Corrosion other than perforation which is due to defective factory materials or workmanship is covered by the full 12-month or 12,000-mile (20,000 km) AMC New Automobile Warranty.

Perforation from corrosion due to accident, damage, abuse or vehicle alteration is not covered under this warranty.

Collision-damaged panels must be repaired or replaced with new fac-

tory-approved or authorized parts and rust-protected within two (2) months to be included in this warranty.

For service under this warranty, you must take your automobile to an AMC dealer for examination and approval by a service representative of American Motors prior to repair or replacement of any part.

Except for other written warranties issued by American Motors applicable to AMC automobiles, no other warranty is given or authorized by American Motors. American Motors shall not be liable for loss of use of automobile, loss of time, inconvenience or other incidental or consequential damages. Some states do not allow the exclusion or limitation of

damages, so the above limitation or exclusion may not apply to you. This warranty gives you specific legal rights, and you may also have other rights which vary from state to state.

Certain equipment items and features illustrated or described in this catalog, are optional at extra cost unless otherwise specified. Certain equipment items and features may not be available for all models. This brochure contains information correct at the time of printing. American Motors, whose policy is one of continual improvement, reserves the right to discontinue or change specifications, models, equipment or price at any time without incurring obligation. AMC, SPIRIT, CONCORD, BUYER PROTECTION PLAN and NO RUST-THRU WARRANTY are trademarks of American Motors Corporation. ZIEBART is a registered trademark of Ziebart International Corporation.

AMC automobiles incorporate thousands of different components produced by American Motors Corporation, affiliated companies and various independent suppliers. From time to time during the manufacturing process, it may be necessary to produce AMC automobiles with different components or differently sourced components than initially scheduled. All components must meet the standards of American Motors Corporation and will provide the performance expected from AMC automobiles.

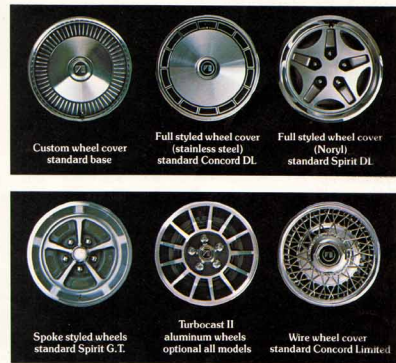

1981 Buyer Protection Plan[®]

Warranty Coverage

This warranty gives you 12-month or 12,000-mile (20,000 km), whichever comes first, coverage on many items not covered by most warranties. It covers wiper blades, brake linings, light bulbs — everything we put on the automobile except tires. If any part American Motors supplies is wrong on your 1981, you won't have to pay for the parts or the labor. You are responsible to see that your automobile is maintained, at your expense, according to the 1981 Owner's Manual and Maintenance Schedule booklet.

Service Adjustments

Any needed service adjustments required during the first 12 months or 12,000 miles (20,000 km) of normal use, whichever comes first, and which are not required as part of normal scheduled maintenance will be performed by an authorized AMC dealer without charge to the customer.

Warranty Service For Owners Who Move or Travel

If you move or are traveling, any AMC dealer in the fifty United States or Canada will perform warranty repairs for you.

Warranty Coverage For Subsequent Owners

Subsequent owners of an AMC automobile are eligible for any unused warranty coverage. A subsequent owner need simply present the warranty folder (properly filled out) to an authorized AMC dealer to obtain warranty repairs.

Tire Policy

The tire manufacturer provides a limited warranty for the tires supplied with your new automobile. Specific warranty information and tire adjustments are handled directly with owners by the tire manufacturer's distributors, dealers or retail stores. Your AMC dealer will assist if you need help in securing an adjustment.

Pre-Delivery Service

Your AMC dealer has serviced and tested your automobile for starting, handling, and braking and overall performance in accordance with AMC's Dealer Pre-Delivery Service Procedure. In addition, many other checks, inspections, adjustments and final clean-up services have been performed to assure your auto meets the quality standards of AMC products.

A Loaner Automobile

If your automobile needs warranty repair work and "same day" (morning to evening) service cannot be completed as promised or if warranty repairs require that it be kept overnight, your AMC dealer will provide you with a free loaner automobile until your auto is ready. To qualify, you must comply with your dealer's work schedule.

Special Trip Interruption Protection

If you're 100 miles (160 km) or more from home and a servicing AMC dealer can't provide "same day" warranty repairs for your automobile, interrupting your trip, we will reimburse you for reasonable extra lodging and meal costs up to \$150, based upon your actual expenses. Submit receipts to the AMC dealer who serviced your automobile. He'll handle the paperwork that generates a direct reimbursement from American Motors to you.

Ziebart[®] Factory Rust Protection

American Motors gives you a full five (5) year warranty which covers perforation due to corrosion for five years from date of delivery or first use, whichever comes first. As the illustration below indicates, American Motors makes extensive use of galvanized steel — a zinc-coated steel that provides excellent protection against corrosion.

Only American Motors has galvanized steel inside all exterior body panels as part of Ziebart[®] Factory Rust Protection

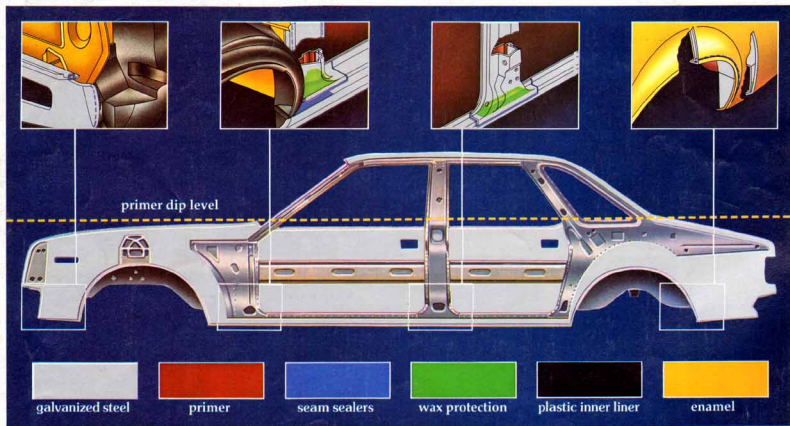

Built to last

 **American Motors**